

No-Opto Isolated Flyback Converter for PSE Applications

DESCRIPTION

Demonstration circuit 1860B is an isolated flyback converter featuring the [LT3748](#). This demo circuit is designed for Power Sourcing Equipment (PSE) applications with a 52.5V output from a 10V to 15V DC input, with nominal input voltage of 12V. The output current is from 0mA to 700mA, and is capable of a maximum short period overload current of 900mA. Table 1 summarizes the performance of the demo board. This demo circuit can also be easily modified for different PSE applications with some pre-designed transformers.

The LT3748 is a high input voltage isolated flyback controller operating with input supply voltages from 5V to 100V, and 1.9A average gate drive source and sink current. The LT3748 utilizes boundary mode operation to provide a high

efficiency, small size solution with improved regulation. The part senses the isolated output voltage directly from the primary side flyback waveform during the off time of the power switch. No third winding, opto-coupler, or signal transformer is required for regulation.

The LT3748 data sheet gives a complete description of the part, operation and application information. The data sheet must be read in conjunction with this quick start guide for demo circuit 1860B.

Design files for this circuit board are available at <http://www.linear.com/demo>

LT, LT, LTC, LTM, Linear Technology and the Linear logo are registered trademarks of Linear Technology Corporation. All other trademarks are the property of their respective owners.

PERFORMANCE SUMMARY (T_A = 25°C)

PARAMETER	CONDITIONS	MIN	TYP	MAX	UNITS
Input Voltage Range		10	12	15	V
Output Voltage	V _{IN} = 10V – 15V I _{OUT} = 0V – 700 mA	50	52.5	55	V
Maximum Output Current	V _{IN} = 10V – 15V	700			mA
Minimum Output Current	V _{IN} = 10V – 15V			0	mA
Output Voltage Ripple (Peak to Peak)	V _{IN} = 10V – 15V, I _{OUT} = 0 – 700mA		150		mV
Efficiency	V _{IN} = 13.2V, I _{OUT} = 700mA		87.8		%

QUICK START PROCEDURE

Demo circuit 1860B is easy to set up to evaluate the performance of the LT3748. Refer to Figure 1 for proper equipment setup and follow the procedure below.

1. With power off, connect the input power supply to the board through V_{IN} (E1) and GND (E2) terminals.
2. Connect the load to the terminals V_{OUT}^+ (E6) and V_{OUT}^- (E7) on the board.
3. Turn on the power at the input. Increase V_{IN} slowly to 10V.

NOTE: Make sure that the input voltage does not exceed 15V. If higher operating voltage is required, power components with higher voltage ratings should be used.

4. Check for the proper output voltages. The output should be regulated at 52.5V ($\pm 5\%$).

NOTE: The LT3748 requires minimum load to maintain good output voltage regulation. A zener diode D1 together with preload resistors R2, R14, R15 and R16 are placed in the output to clamp the output voltage to $\sim 52.5V$ without

ex-board preload requirement. The efficiency is higher than 90% without the preload resistors, but the output may exceed 57V under no load or transient condition.

5. Once the proper output voltage is established, adjust the input voltage and load current within the operating range and observe the output voltage regulation, ripple voltage, efficiency and other parameters.

NOTE: When measuring the input or output voltage ripples, care must be taken to avoid a long ground lead on the oscilloscope probe. Measure the input or output voltage ripple by touching the probe tip directly across the terminals of the input or output capacitor. See Figure 2 for proper scope probe technique.

NOTE: A gate resistor of less than 10Ω can be added to the demo circuit to slow down the turning off of the switch, and reduce the switching node voltage spike. A RC snubber can be added as well to the primary winding of the transformer to damp the spike and reduce the EMI.

QUICK START PROCEDURE

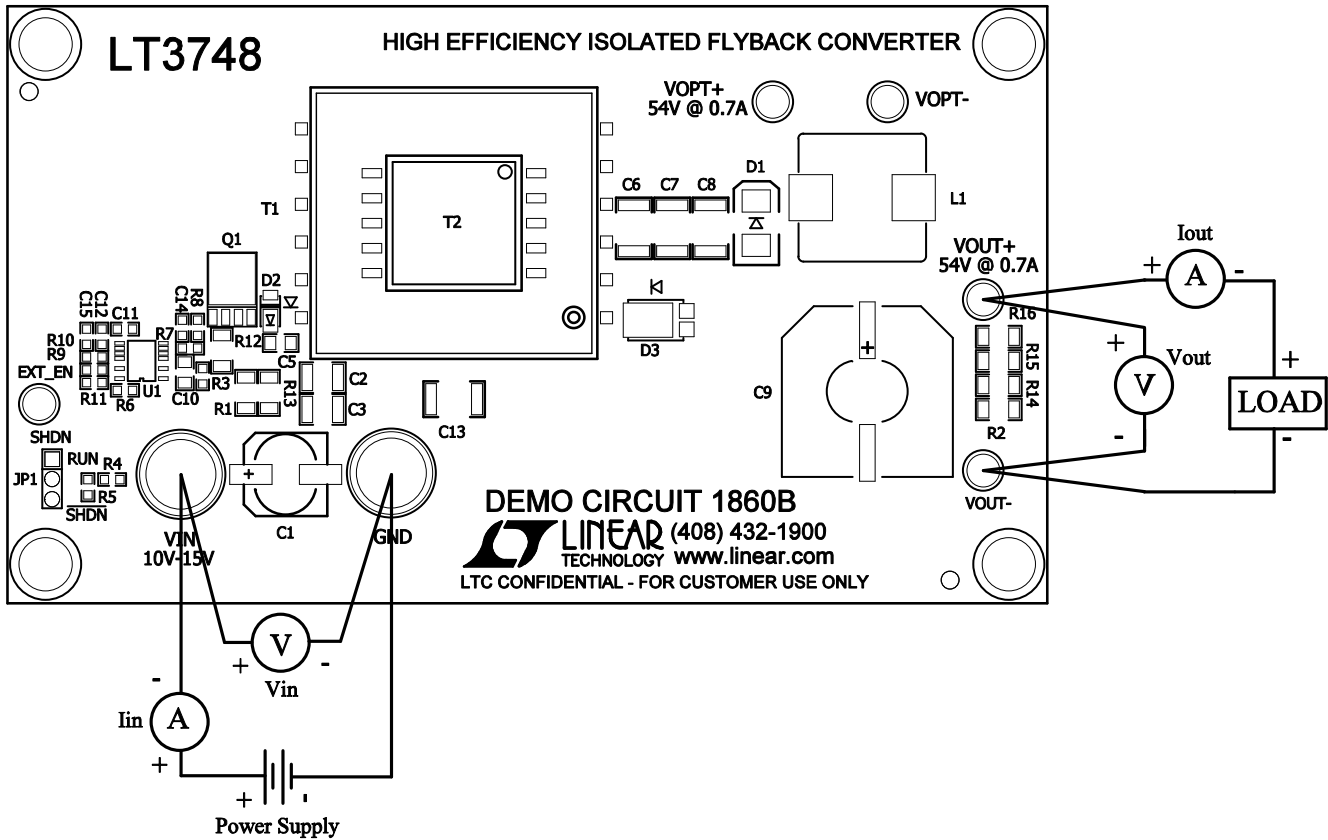

Figure 1. Proper Measurement Equipment Setup

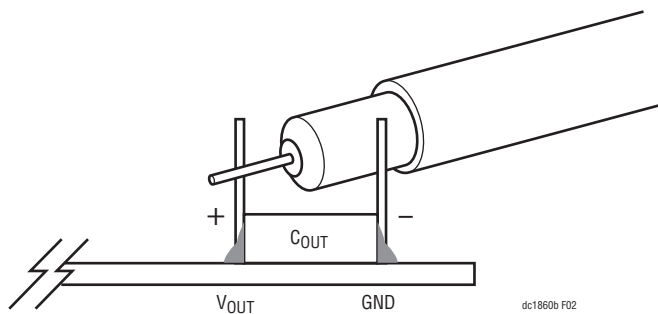

Figure 2. Proper Scope Probe Placement for Measuring Input or Output Ripple

QUICK START PROCEDURE

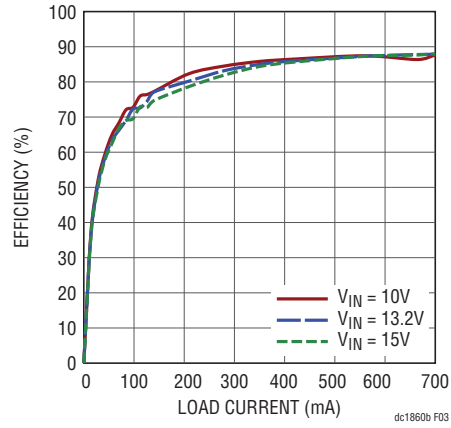

Figure 3. Typical Efficiency Curve, ($T_A = 25^\circ\text{C}$)

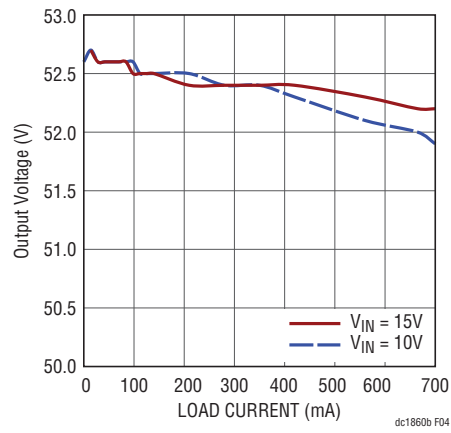

Figure 4. Load Regulation

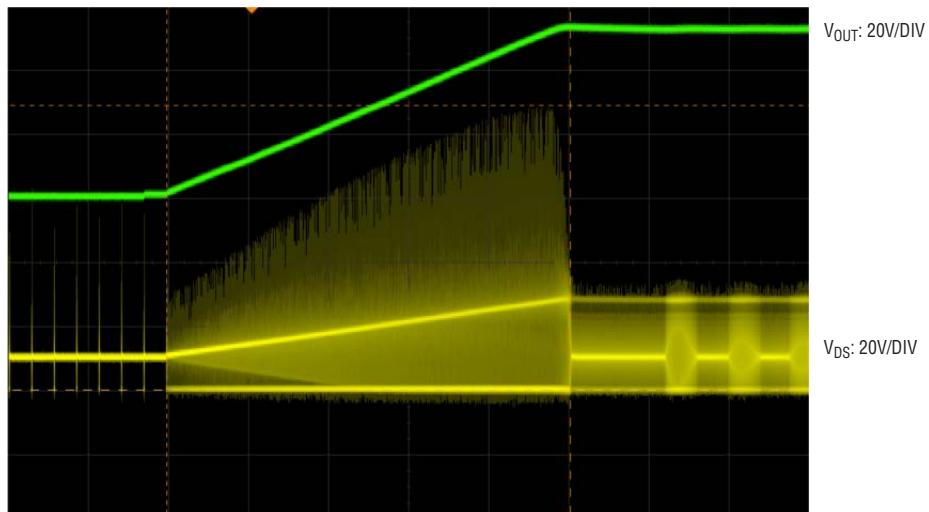

Figure 5. Recovery from Short Circuit Fault

PARTS LIST

ITEM	QTY	REFERENCE	PART DESCRIPTION	MANUFACTURER/PART NUMBER
Required Circuit Components				
1	2	C2, C3	Cap., X5R, 22µF, 16V, 20%, 1210	Taiyo Yuden EMK325BJ226MN
2	1	C5	Cap., X7S, 0.22µF, 100V, 10%, 0805	TDK C2012X7S2A224KT
3	3	C6, C7, C8	Cap., X7S, 4.7µF, 100V, 20%, 1812	TDK C4532X7S2A475MT
4	1	C9	Cap., Elect. 470µF, 63V, 20%, J16-PANASONIC	PANASONIC EEVFK1J471M
5	1	C10	Cap., X5R, 4.7µF, 16V, 20%, 0805	Taiyo Yuden EMK212BJ475MG
6	1	C11	Cap., X5R, 0.33µF, 10V, 20%, 0603	AVX 0603ZD334MAT1A
7	1	C12	Cap., NPO, 470pF, 25V, 10%, 0603	AVX 06033A471KAT2A
8	1	C13	Cap., Ceramic 2.2nF, 250V, 10%, 1812	Murata GA343QR7GD222KW01L
9	2	C14, C15	Cap., X7R, 6800pF, 25V, 20%, 0603	AVX 06033C682MAT2A
10	1	D1	Diode Zener 62V	ON Semi. 1SMB5943BT3
11	1	D2	Schottky Diode 1A/100V, PowerDItm123	Diodes Inc. DFSL1100
12	1	D3	Schottky Diode 3A, PowerDi5	Diodes Inc. PDS3200-13
13	1	L1	Inductor, 1.8µH	Würth Elektronik 744318180
14	1	Q1	Mosfet N-Channel, 100V, LPAK	Renesas HAT2173H-EL-E
15	2	R1, R13	Res., Chip, 16k, 0.25W, 5%, 1206	Vishay CRCW120616K0JNED
16	4	R2, R14, R15, R16	Res., Chip, 11.8k, 0.25W, 1%, 1206	Vishay CRCW120611K8FKEA
17	2	R3, R7	Res/Jumper, Chip, 0Ω, 1/16W, 1 AMP 0603	Vishay CRCW06030000Z0EA
18	1	R4	Res., Chip, 200k, 0.06W, 1%, 0603	Vishay CRCW0603200KFKEA
19	1	R5	Res., Chip, 36k, 0.06W, 5%, 0603	Vishay CRCW060336K0JNEA
20	1	R6	Res., Chip, 82.5k, 0.06W, 1%, 0603	Vishay CRCW060382K5FKEA
21	1	R8	Res., Chip, 22, 0.06W, 5%, 0603	Vishay CRCW060322R0JNEA
22	1	R9	Res., Chip, 270k, 0.06W, 5%, 0603	Vishay CRCW0603270KJNEA
23	1	R10	Res., Chip, 40.2k, 0.06W, 1%, 0603	Vishay CRCW060340K2FKEA
24	1	R11	Res., Chip, 6.04k, 0.06W, 1%, 0603	Vishay CRCW06036K04FKEA
25	1	R12	Res., 0.005, 0.25W, 1%, 1206	Vishay Dale WSL-1206-5L000-1%
26	1	T1	Transformer, XFMR	Würth Elektronik 750311591
27	1	U1	I.C., LT3748EMS	Linear Tech. Corp. LT3748EMS
Hardware For Demo Board Only				
1	2	E1, E2	Connector, Banana Jack	Keystone 575-4
2	3	E5, E6, E7	Turret, Testpoint	Mill Max 2501-2-00-80-00-00-07-0
3	1	JP1	Headers, Sgl. Row, 3 Pins, 2mm Ctrs.	Samtec TMM-103-02-L-S
4	4	MH1, MH2, MH3, MH4	STAND-OFF, NYLON 0.25" tall	KEYSTONE, 8831(SNAP ON)
5	1	XJP1	Shunt, 2mm Ctrs.	Samtec 2SN-BK-G
6	1		FAB, 1860B, Rev 3.PCB	DEMO CIRCUIT 1860B
7	2		STENCILS - TOP & BOTTOM	STENCIL DC1860B
Additional Demo Board Circuit Components				
1	0	C1 (Opt)	Cap., Alum 330µF, 25V, 10%, 25cv330gX	SANYO 25CV330gX
2	0	C16 (Opt)	Cap., Alum. Elect. 100µF, 63V, ±20%, NipponChemi-Con/JA0	Nippon Chemi-Con EMZA630ADA101MJA0G
3	0	L2 (Opt)	Inductor, 47µH, IHLP4040	VISHAY IHLP-4040DZ-ER-470-M11
4	0	T2 (Opt)	Transformer, XFMR	Würth Elektronik 750311456
5	0	T3 (Opt)	Transformer, XFMR	Würth Elektronik 750311604
6	0	E3, E4 (Opt)	Turret, Testpoint	Mill Max 2501-2-00-80-00-00-07-0

DEMO MANUAL DC1860B

SCHEMATIC DIAGRAM

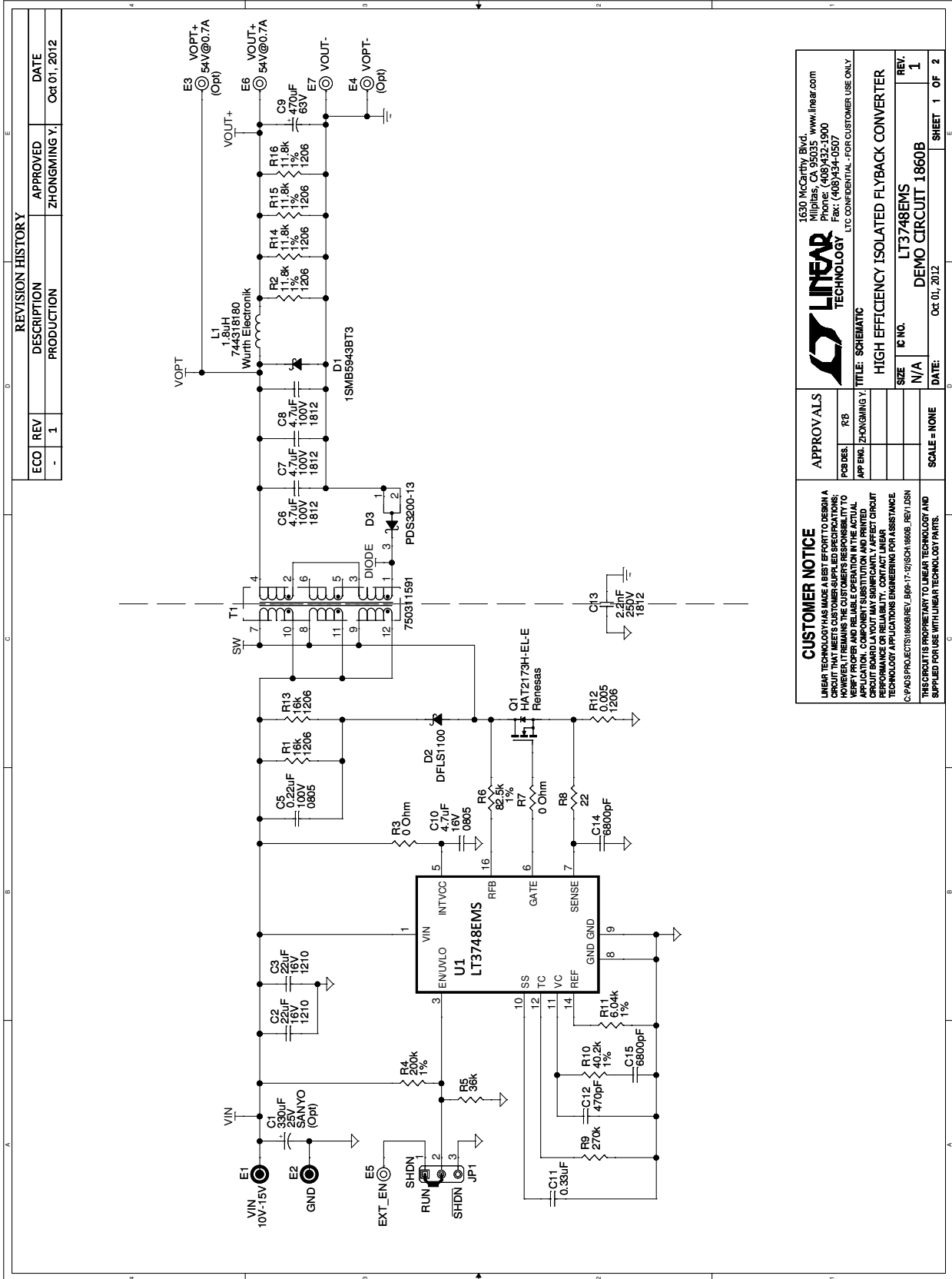

1650 McCarthy Blvd., www.linear.com
 Milpitas, CA 95033-9000
 Fax: (408)34-0507

LINEAR TECHNOLOGY
LTC CONFIDENTIAL - FOR CUSTOMER USE ONLY

TITLE: SCHEMATIC
 HIGH EFFICIENCY ISOLATED FLYBACK CONVERTER

SIZE	IC NO.	REV.
N/A	LT3748EMS	1

DATE: Oct 01, 2012
 SHEET 1 OF 2

CUSTOMER NOTICE
 LINEAR TECHNOLOGY HAS MADE A BEST EFFORT TO DESIGN A CIRCUIT THAT MEETS CUSTOMER-SUPPLIED SPECIFICATIONS; HOWEVER, IT REMAINS THE CUSTOMER'S RESPONSIBILITY TO VERIFY PROPER AND RELIABLE OPERATION IN THE ACTUAL APPLICATION. CUSTOMER'S SPECIFICATIONS, PARTS LIST, AND CIRCUIT BOARD LAYOUT MAY SIGNIFICANTLY AFFECT CIRCUIT PERFORMANCE OR RELIABILITY. CONTACT LINEAR TECHNOLOGY APPLICATIONS ENGINEERING FOR ASSISTANCE.
© LINEAR TECHNOLOGY 2012. PROJECTS 1860B/REV. 0/08-17-2012/SCH 1860B_REV1.DSN

THIS CIRCUIT IS PROPRIETARY TO LINEAR TECHNOLOGY AND IS SUPPLIED FOR USE WITH LINEAR TECHNOLOGY PARTS.

SCHEMATIC DIAGRAM

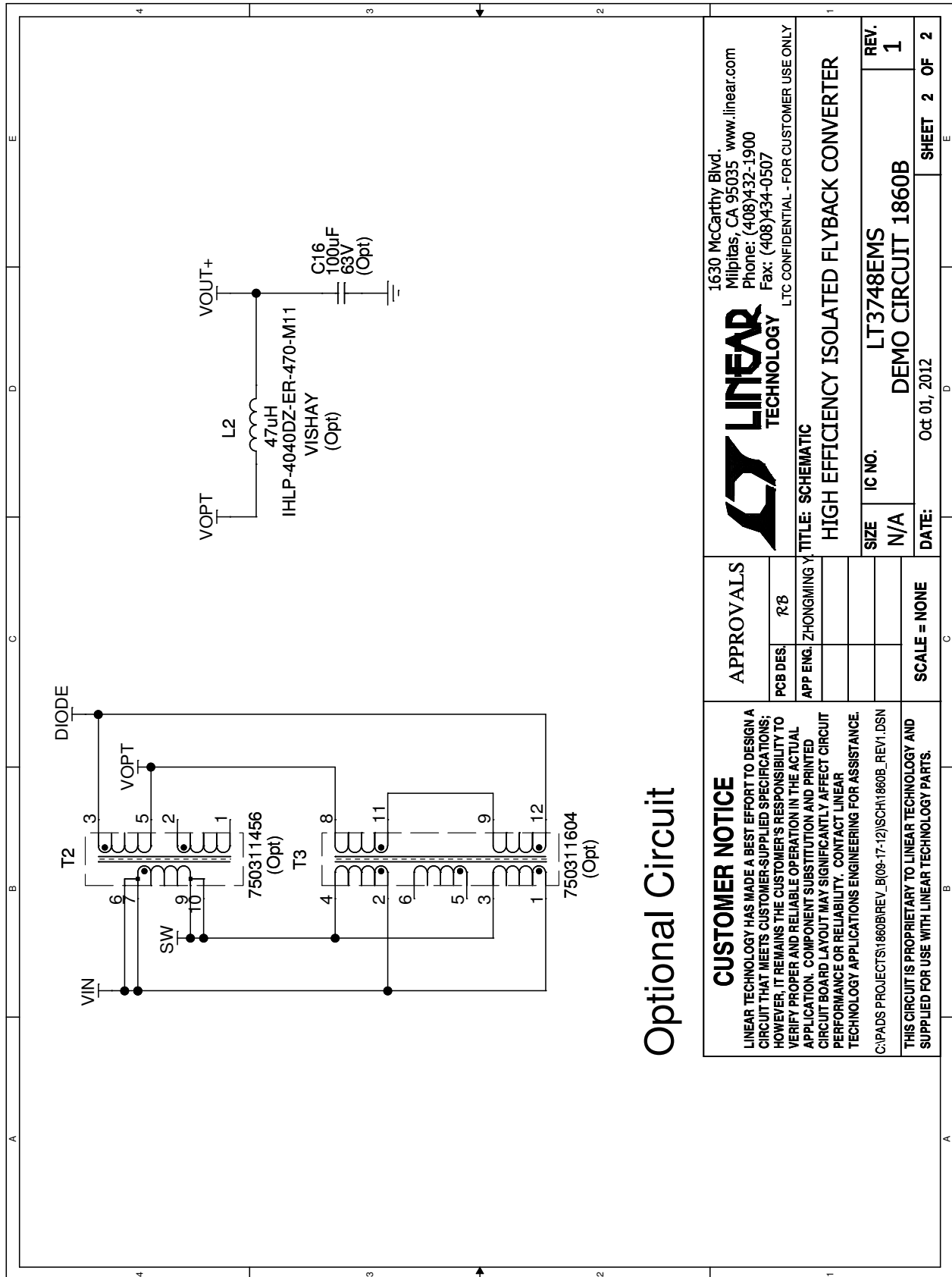

Optional Circuit

<p>CUSTOMER NOTICE LINEAR TECHNOLOGY HAS MADE A BEST EFFORT TO DESIGN A CIRCUIT THAT MEETS CUSTOMER-SUPPLIED SPECIFICATIONS; HOWEVER, IT REMAINS THE CUSTOMER'S RESPONSIBILITY TO VERIFY PROPER AND RELIABLE OPERATION IN THE ACTUAL APPLICATION. COMPONENT SUBSTITUTION AND PRINTED CIRCUIT BOARD LAYOUT MAY SIGNIFICANTLY AFFECT CIRCUIT PERFORMANCE OR RELIABILITY. CONTACT LINEAR TECHNOLOGY APPLICATIONS ENGINEERING FOR ASSISTANCE. C:\PADS PROJECTS\1860B\REV_B\09-17-12\SCH1860B_REV1.DSN</p>		<p>APPROVALS</p> <table border="1"> <tr> <td>PCB DES.</td> <td>R B</td> </tr> <tr> <td>APP ENG.</td> <td>ZHONGMING Y</td> </tr> </table>		PCB DES.	R B	APP ENG.	ZHONGMING Y
PCB DES.	R B						
APP ENG.	ZHONGMING Y						
<p>LINEAR TECHNOLOGY 1630 McCarthy Blvd. Milpitas, CA 95035 www.linear.com Phone: (408)432-1900 Fax: (408)434-0507 LTC CONFIDENTIAL - FOR CUSTOMER USE ONLY</p>		<p>TITLE: SCHEMATIC HIGH EFFICIENCY ISOLATED FLYBACK CONVERTER</p>					
<p>SIZE IC NO. LT3748EMS</p>		<p>REV. 1</p>					
<p>DATE: Oct 01, 2012</p>		<p>SHEET 2 OF 2</p>					



Information furnished by Linear Technology Corporation is believed to be accurate and reliable. However, no responsibility is assumed for its use. Linear Technology Corporation makes no representation that the interconnection of its circuits as described herein will not infringe on existing patent rights.

DEMO MANUAL DC1860B

DEMONSTRATION BOARD IMPORTANT NOTICE

Linear Technology Corporation (LTC) provides the enclosed product(s) under the following **AS IS** conditions:

This demonstration board (DEMO BOARD) kit being sold or provided by Linear Technology is intended for use for **ENGINEERING DEVELOPMENT OR EVALUATION PURPOSES ONLY** and is not provided by LTC for commercial use. As such, the DEMO BOARD herein may not be complete in terms of required design-, marketing-, and/or manufacturing-related protective considerations, including but not limited to product safety measures typically found in finished commercial goods. As a prototype, this product does not fall within the scope of the European Union directive on electromagnetic compatibility and therefore may or may not meet the technical requirements of the directive, or other regulations.

If this evaluation kit does not meet the specifications recited in the DEMO BOARD manual the kit may be returned within 30 days from the date of delivery for a full refund. **THE FOREGOING WARRANTY IS THE EXCLUSIVE WARRANTY MADE BY THE SELLER TO BUYER AND IS IN LIEU OF ALL OTHER WARRANTIES, EXPRESSED, IMPLIED, OR STATUTORY, INCLUDING ANY WARRANTY OF MERCHANTABILITY OR FITNESS FOR ANY PARTICULAR PURPOSE. EXCEPT TO THE EXTENT OF THIS INDEMNITY, NEITHER PARTY SHALL BE LIABLE TO THE OTHER FOR ANY INDIRECT, SPECIAL, INCIDENTAL, OR CONSEQUENTIAL DAMAGES.**

The user assumes all responsibility and liability for proper and safe handling of the goods. Further, the user releases LTC from all claims arising from the handling or use of the goods. Due to the open construction of the product, it is the user's responsibility to take any and all appropriate precautions with regard to electrostatic discharge. Also be aware that the products herein may not be regulatory compliant or agency certified (FCC, UL, CE, etc.).

No License is granted under any patent right or other intellectual property whatsoever. **LTC assumes no liability for applications assistance, customer product design, software performance, or infringement of patents or any other intellectual property rights of any kind.**

LTC currently services a variety of customers for products around the world, and therefore this transaction **is not exclusive**.

Please read the DEMO BOARD manual prior to handling the product. Persons handling this product must have electronics training and observe good laboratory practice standards. **Common sense is encouraged.**

This notice contains important safety information about temperatures and voltages. For further safety concerns, please contact a LTC application engineer.

Mailing Address:

Linear Technology
1630 McCarthy Blvd.
Milpitas, CA 95035

Copyright © 2004, Linear Technology Corporation