

PROPORTIONAL OUTPUT THUMBWHEEL

HTWF
HALL EFFECT
THUMBWHEEL

FRICITION HOLD ACTUATION STYLE THUMBWHEEL

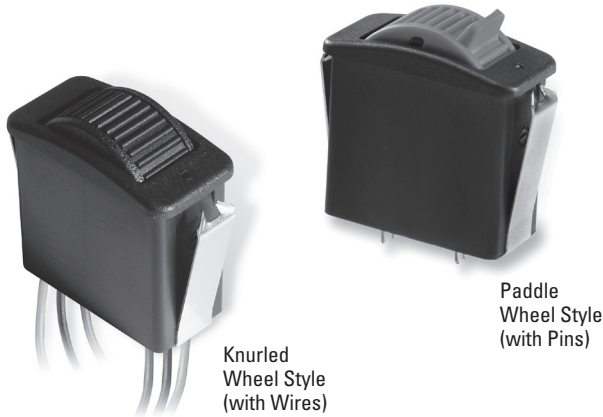

Knurled Wheel Style (with Wires)

Paddle Wheel Style (with Pins)

The HTWF Friction Hold Thumbwheel offers a maintained position, single axis thumbwheel actuator that provides a linear change in voltage output in either direction from center. Options include increasing or decreasing voltage output from the center position to the full travel position, and single or dual (redundant) outputs per axis. The HTWF Thumbwheel has a rocker style snap-in mounting feature to accommodate a 1.47" x 0.710" panel opening. The HTWF provides 250,000 cycle life, full forward/full backward, is sealed to IP68S and offers excellent EMI/RFI immunity and a flow through design. Ideal for heavy equipment, industrial machines or remote control applications.

Features:

- 250,000 cycle life, full forward/full backward with center detent
- Maintained control positioning, no return to center
- Hall effect contactless sensing technology
- Number of output options
- Choice of bezel & button colors
- Snaps into 1.47" x 0.710" panel opening
- Electronics sealed to IP68S
- Excellent EMI/RFI immunity
- RoHS/WEEE/Reach compliant

Standard Characteristics/Ratings:

MECHANICAL:

Mechanical Life: 250,000 full forward to full back with center detent

Initial Operating Force at Top of Roller: 2 oz min to 6 oz max @ 25°C

Max Allowable Radial Load: 30.0 lbs.

ELECTRICAL RATINGS: Rated at Vcc = 5V @ 25°C Load = 1mA (4.7KΩ)

Electrical	Units	Min	Typ	Max
Supply Voltage	VDC	4.5	5	5.5
Output Voltage Tolerance at Center (see graph for output values)	VDC @ 5V Vcc	-0.15	N/A	+0.15
Output Voltage Tolerance Full Travel (see graph for output values)	VDC @ 5V Vcc	-0.25	N/A	+0.25
Supply Current Per Sensor	mA	N/A	N/A	10

ELECTRONICS:

Seal Integrity: Electronics watertight per IP68S, 1 meter

ENVIRONMENTAL:

Operating Temp Range: -40°C to +85°C

Humidity: 96% RH, 70°C, 96 hours

Vibration: Per MIL-810F minimum integrity

Sand/Dust: Per SAE J1455

EMI: Withstand per MIL-STD-461D/SAE J1113-22

RFI: Withstand 100V/M 14Hz to 1GHz

MATERIALS:

Button: Thermoplastic

Bezel: Thermoplastic

Snap Arms: Stainless steel

Wires: 18 AWG

HTWF PART NUMBER CODE

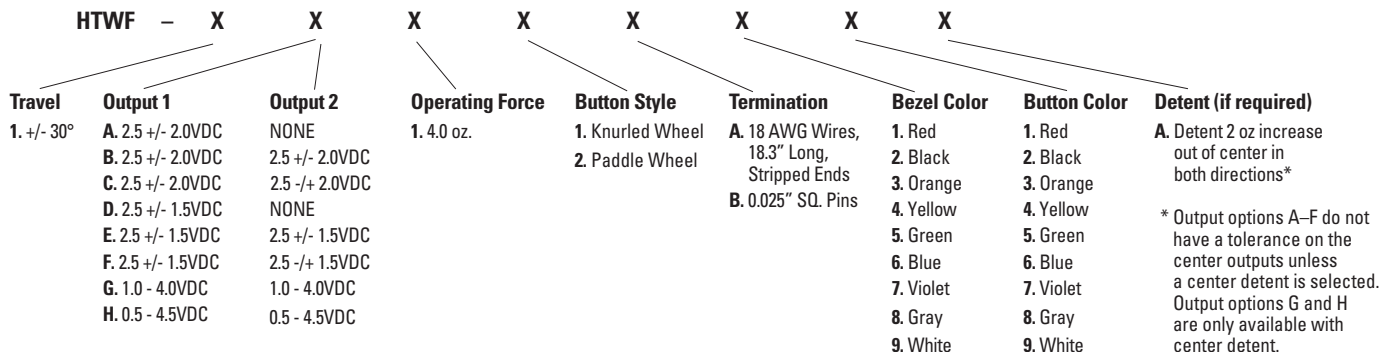

FRICION HOLD ACTUATION STYLE THUMBWHEEL

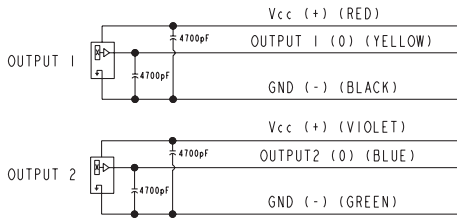
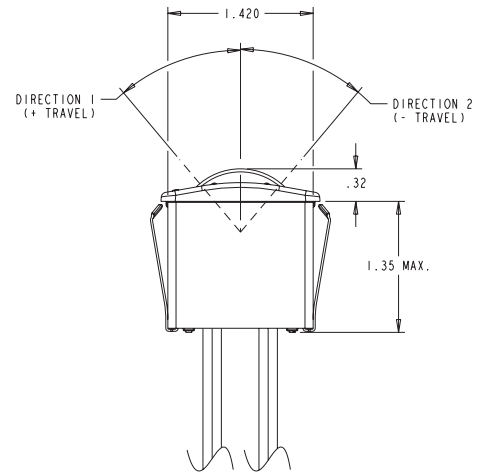
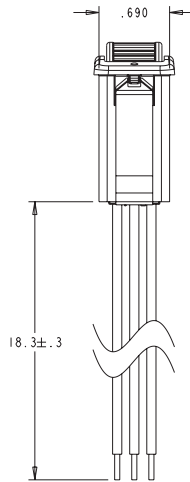
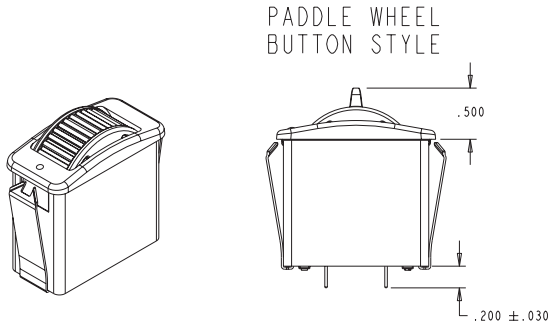

OUTPUT 2 IS NOT PRESENT IN ALL CONFIGURATIONS

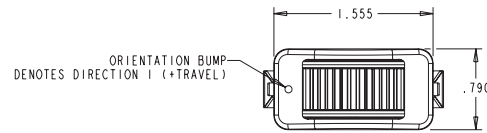

MOUNTING:

RECOMMENDED PANEL THICKNESS: 0.100 OPTIMUM THICKNESS
(0.050 MIN. - 0.120 MAX.)

RECOMMENDED PANEL OPENING: 0.710 X 1.470 OPTIMUM
(0.710/0.720 - 1.460/1.480)

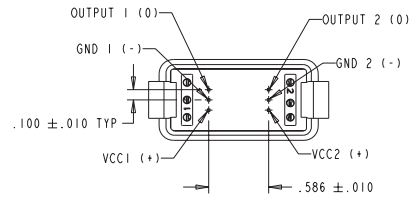
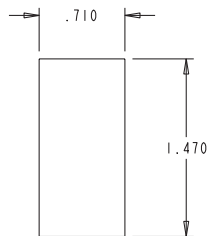

**PINNED
TERMINATION**
NOT ALL PINS ARE PRESENT
IN ALL OUTPUT CONFIGURATIONS

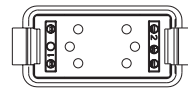

NOT ALL WIRES ARE PRESENT
IN ALL OUTPUT CONFIGURATIONS

PROPORTIONAL OUTPUT THUMBWHEEL

FRICTION HOLD ACTUATION STYLE THUMBWHEEL

OPTION A

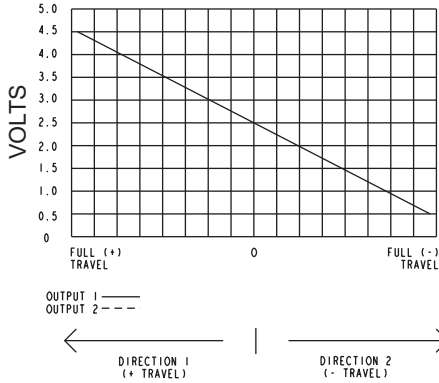

OPTION B

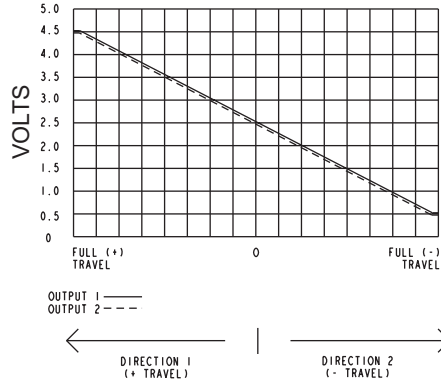

OPTION C

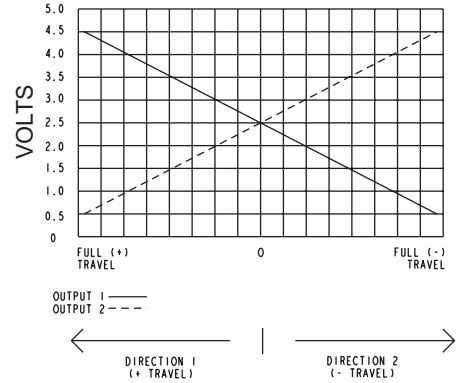

OPTION D

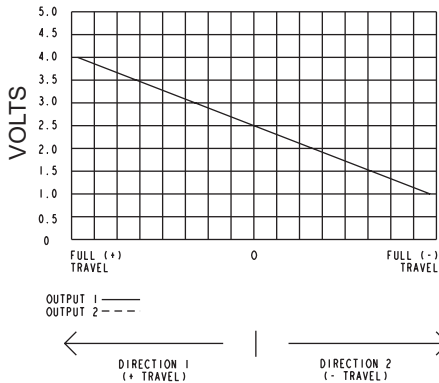

OPTION E

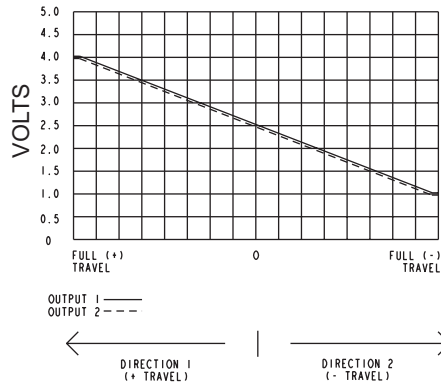

OPTION F

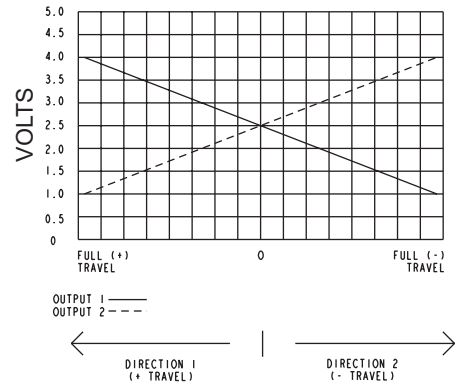

OPTION G

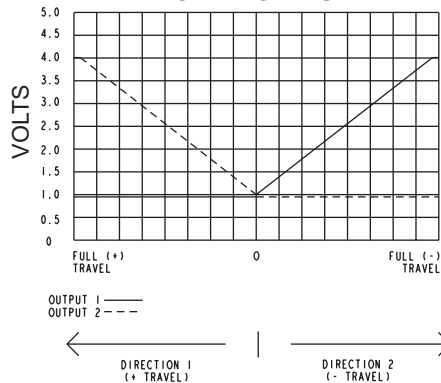

OPTION H

