

# *Servo-Motor-Kit*

 **User Manual**

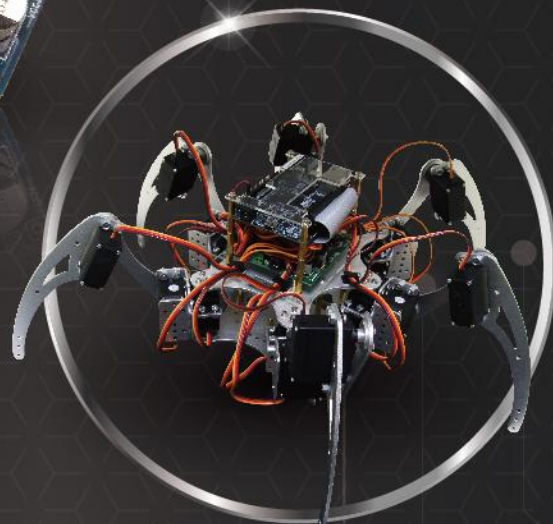
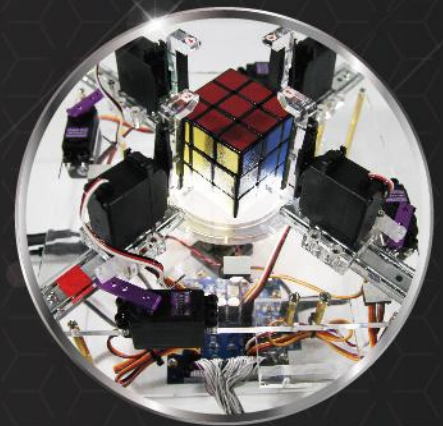
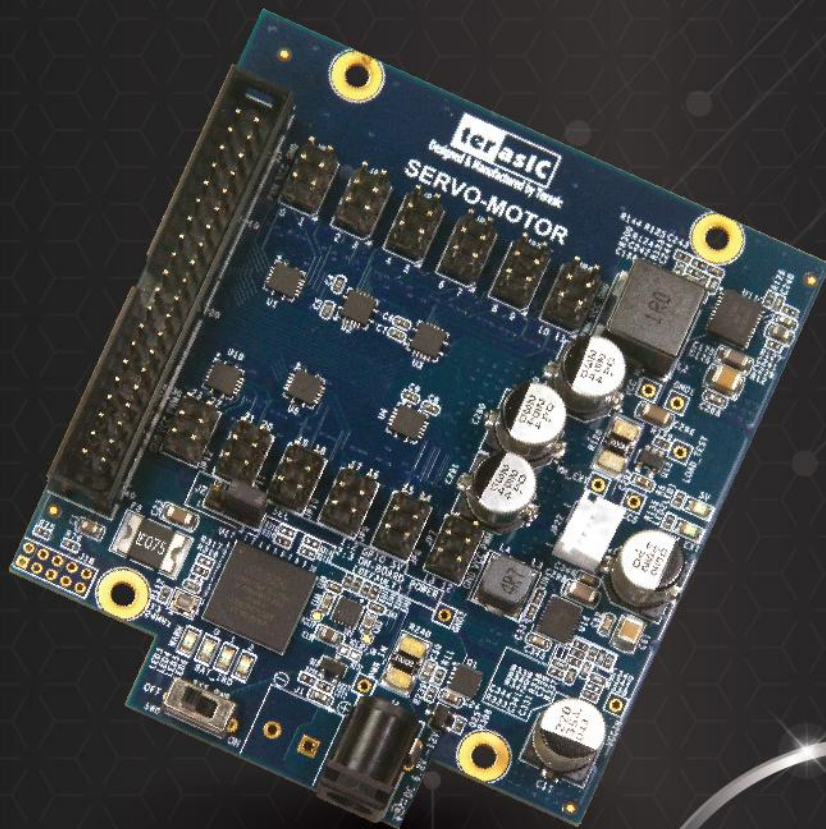

<b>Chapter 1</b>	<b>Servo Motor Kit</b>	<b>1</b>
1.1	Package Contents	1
1.2	SMK System CD	2
1.3	Assemble the Servo Motor	2
1.4	Getting Help	5
<b>Chapter 2</b>	<b>Servo Motor Card</b>	<b>6</b>
2.1	Features	6
2.2	Block Diagram of Servo Motor Card	7
2.3	Interface of Servo Motor Card	8
2.4	Power for Motor Card	8
2.5	Interface for FPGA Host	9
2.6	Interface for Servo Motor	11
2.7	CPLD Code for Power Monitor	12
2.8	Servo Motor Control	12
<b>Chapter 3</b>	<b>Design Example</b>	<b>14</b>
3.1	Function Block Diagram	14
3.2	Demo Setup	15

# Chapter 1

## *Servo Motor Kit*

---

The SMK (Servo Motor Kit) is designed for developer who wish to learn servo motor control and build their robot machine. It includes one servo motor driver daughter card and one servo motor. The motor driver card can drive 24 RC servo motors at most. The motor daughter card can be linked to the FPGA development kit via the 2x20 Pin GPIO connector.

The PWM IP and some example designs on different FPGA development boards are also provided in the kit. By referring these demos, the user can quickly learn how to work with the servo motor and build their own robot machine.

### 1.1 Package Contents

The SMK package includes

- Servo Motor Daughter Card
- RC Servo Motor
- 40-pin Cable
- System CD Download Guide



**Figure 1-1** The SMK package contents

## 1.2 SMK System CD

The SMK System CD contains all the documents and supporting materials associated with Servo Motor Kit, including the user manual, reference designs, and device datasheets. Users can download this system CD from the link: <http://smk.terasic.com/cd>.

## 1.3 Assemble the Servo Motor

The servo motor and motor daughter card can be connected to any FPGA development kit that is equipped with a 2x20 Pin GPIO connector. The pictures below show how the servo motor card is connected to various Terasic FPGA Boards:

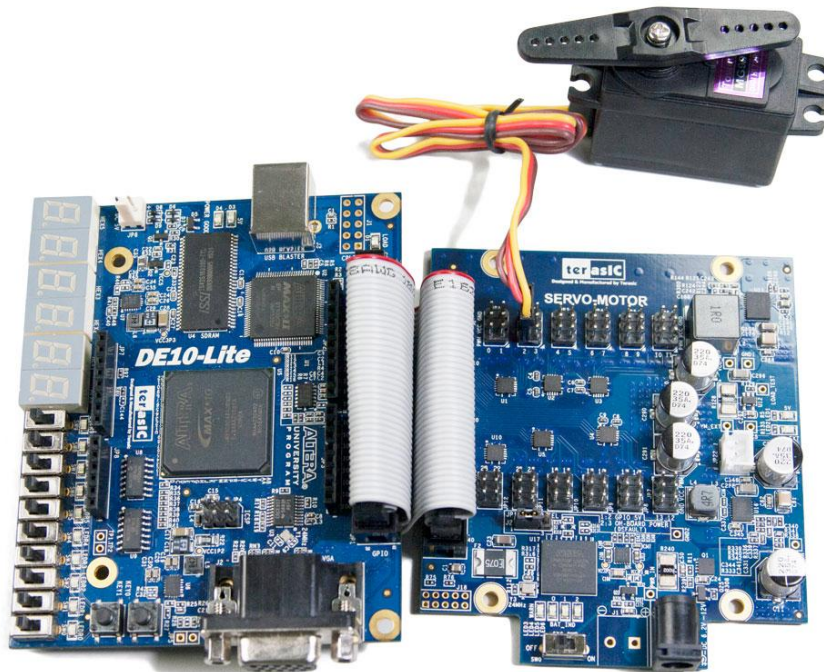

**Figure 1-2 Connect the Servo Motor and Motor Card to DE10-Lite**

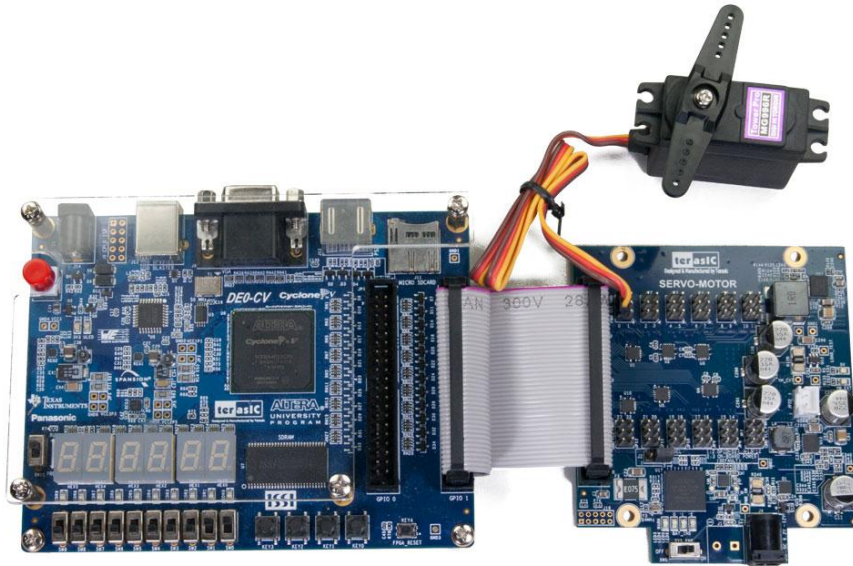

**Figure 1-3 Connect the Servo Motor and Motor Card to DE0-CV**

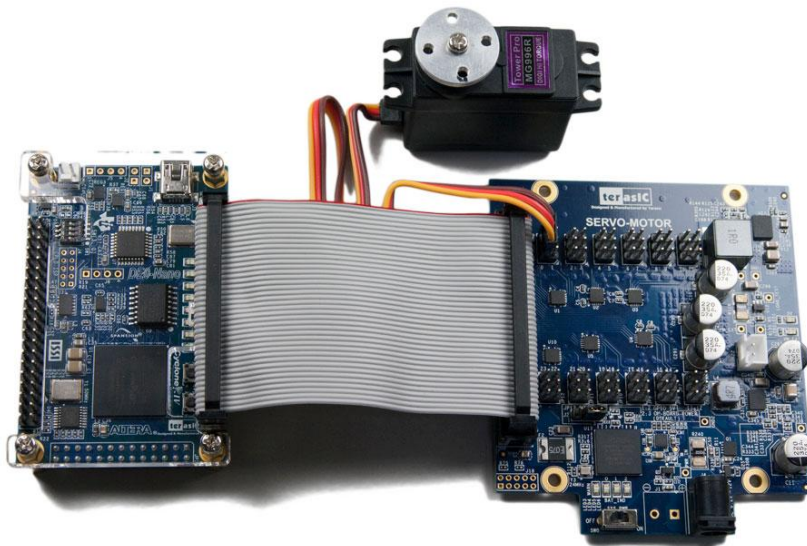

**Figure 1-4 Connect the Servo Motor and Motor Card to DE0-Nano**

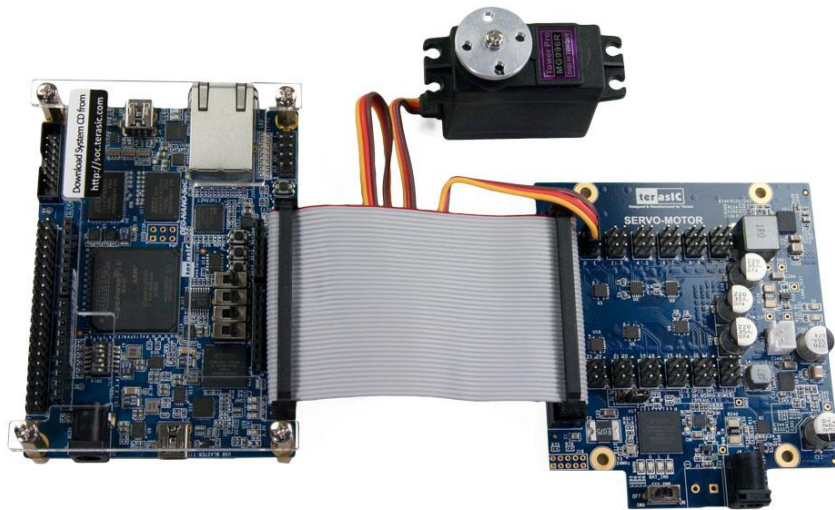

**Figure 1-5 Connect the Servo Motor and Motor Card to DE0-Nano-SoC**

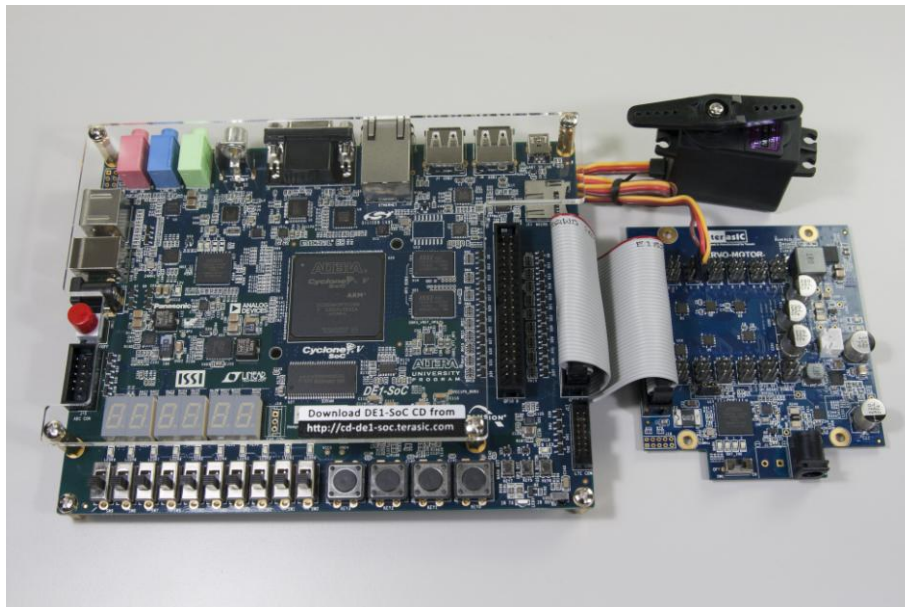

**Figure 1-6 Connect the Servo Motor and Motor Card to DE1-SoC**

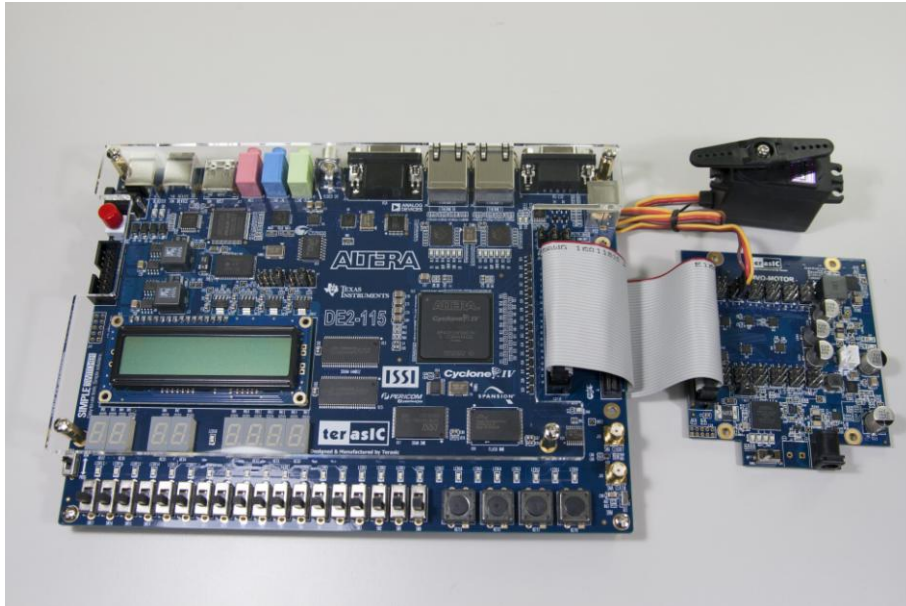

**Figure 1-7 Connect the Servo Motor and Motor Card to DE2-115**

## 1.4 Getting Help

Here are the addresses where you can get help if you encounter any problems:

Terasic Technologies

9F., No.176, Sec.2, Gongdao 5th Rd, East Dist, Hsinchu City, 30070. Taiwan

Email: [support@terasic.com](mailto:support@terasic.com)

Tel.: +886-3-575-0880

Website: <http://smk.terasic.com>

# Chapter 2

## *Servo Motor Card*

This chapter will introduce the servo motor daughter card included in the Kit. The daughter card is mainly responsible for converting the 3.3V PWM signals from FPGA into 5.0V PWM signals to control the rotate angle of servo motors. Besides, the daughter card also provide 6V DC needed to drive the motor.

### 2.1 Features

Figure 2-1 shows a photograph of the servo motor daughter card.



**Figure 2-1 Servo Motor Card**

The major purpose of the servo motor card is to drive the servo motor. It receives PWM signal from the host FPGA board, converts the voltage of the PWM, then sends the PWM to the servo motor. The motor will rotate to a desired angle based on the PWM duty cycle it receives.

The features of the servo motor card are:

- Input 6.2~12V DC to generate 6V DC to drive servo motors.
- Translate 3.3V PWM to 5.0V PWM
- Provide 5V DC power output for host
- 2X20 3.3V GPIO Interface for host
- Drive 24 servo motors at most
- Fuse protection for each servo driving port



- MIPI Build-In Altera CPLD and Power Monitor Chip:
  - Battery voltage monitor
  - Total current monitor
  - Auto shutdown when battery is low or total current is too high.
  - Source code is available for users to modify according to their application.

## 2.2 Block Diagram of Servo Motor Card

Figure 2-2 shows the block diagram of the servo motor card. There are 24 level shift populated to convert the voltage level of PWM signals from 3.3V to 5.0V. The 6V power regulator provides 6V DC for the servo motor. The CPLD is configured to monitor the power constantly. When an exception is detected, it will automatically shut down the motor. The board power comes from the DC jack and 6.2 ~ 12V DC power is expected. The 5V DC output power can be used to supply 5V power for the FPGA mainboards designed with 5V input requirement.

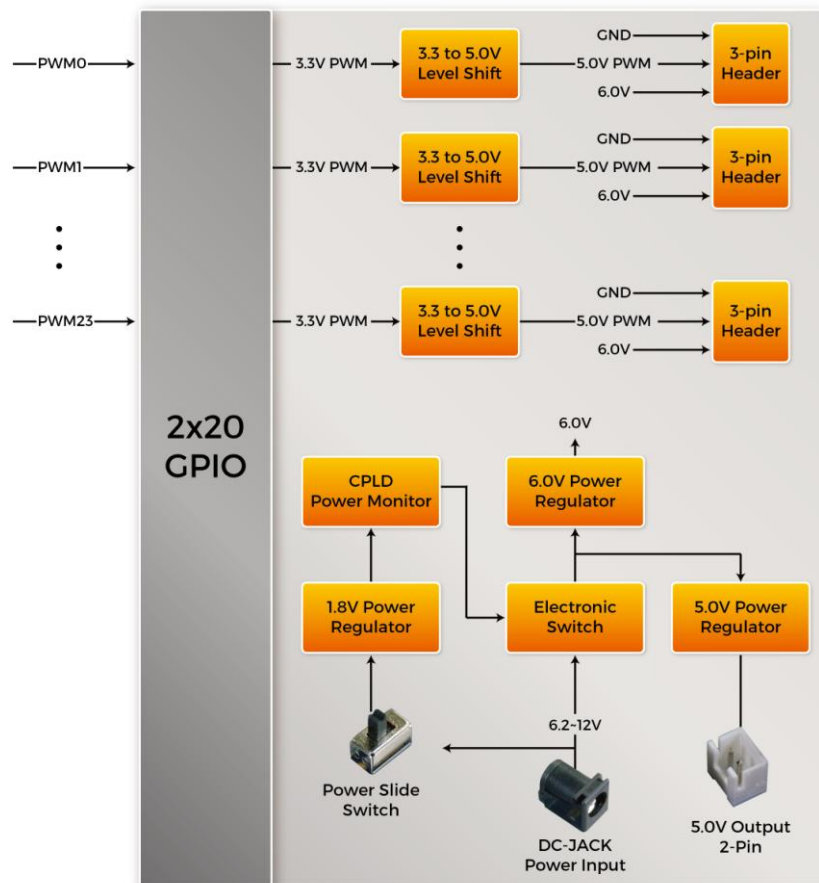

Figure 2-2 Block Diagram of Servo Motor Card

## 2.3 Interface of Servo Motor Card

Figure 2-3 shows main interface of the servo motor card. The 2x20 GPIO is used to connect to the FPGA mainboard to get 24 PWM control signals from the FPGA. There are 24 1x3 SERVO HEADER on the board. These 24 header can be used to drive 24 servo motors. The DC JACK receives 6.2~12.0V DC source to provide power for the motor card. DC 6V is generated to drive servo motors. The DC 5V OUPUT connector can output 5V DC power which can be used to provide power for FPGA main board. The POWER SWITCH is used to turn the power on/off the motor card. When POWER SWITCH is set to off position, the servo motor will stop immediately.

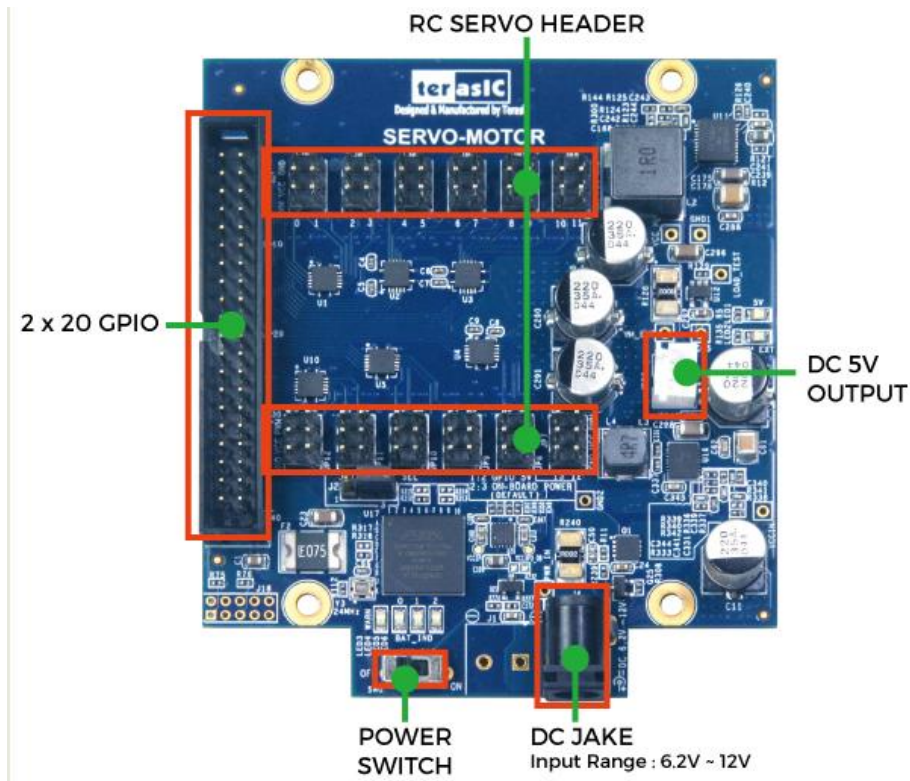
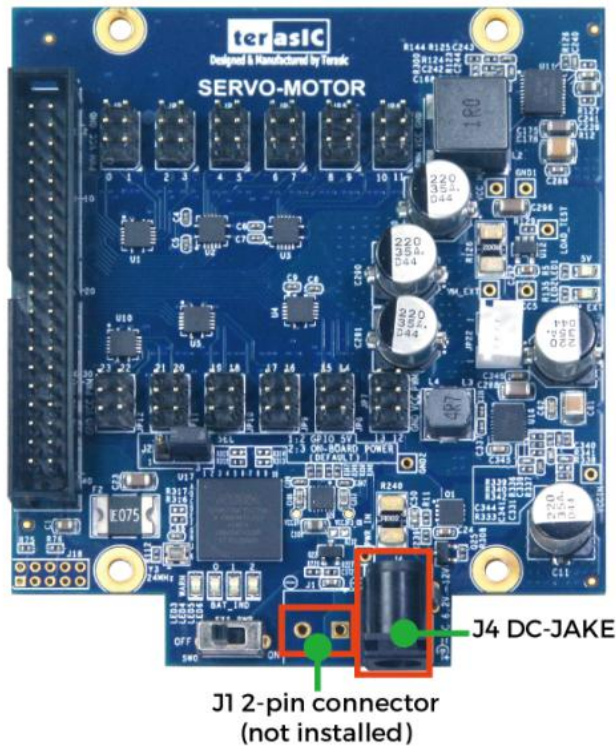

Figure 2-3 Main interface of the servo motor card

## 2.4 Power for Motor Card

External 6.2V~12V DC power is required for the motor card to work. Users can provide the required power from the J4 DC-Jack or the J1 2-pin connector (not installed) as shown in Figure 2-4. If DC-Jack is used, please make sure the DC-Plug of the power source is meet required specification as shown in Figure 2-5. Terasic also provide the power supply, user can change the power supply from <http://smk.terasic.com/buy>.

**Note, do not provide power from J4 DC Jack and J1 2-pin power input at the same time. Otherwise, the board will be damaged.**



**Figure 2-4 Power Input J4 and J1**

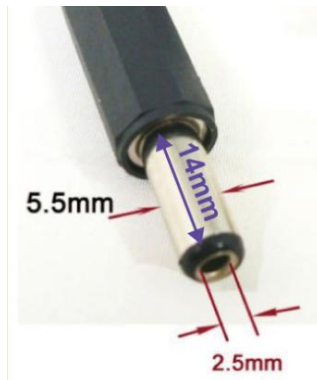

**Figure 2-5 DC-Plug Specificaiton**

## 2.5 Interface for FPGA Host

The servo motor card is connected to the host FPGA through the JP0 - a 2x20 GPIO header as shown in **Figure 2-6**. There are 24 PWM channels, labeled as PWM0 to PWM23, in the 2x20 GPIO header. When driving servo motor, the PMW signals is sent from the host FPGA with IO standard 3.3V. The Host FPGA board should then provide 3.3V in the VCC3P for the daughter card to use it

as reference voltage in level shift circuit. The VCC5\_EXT is not used in general.

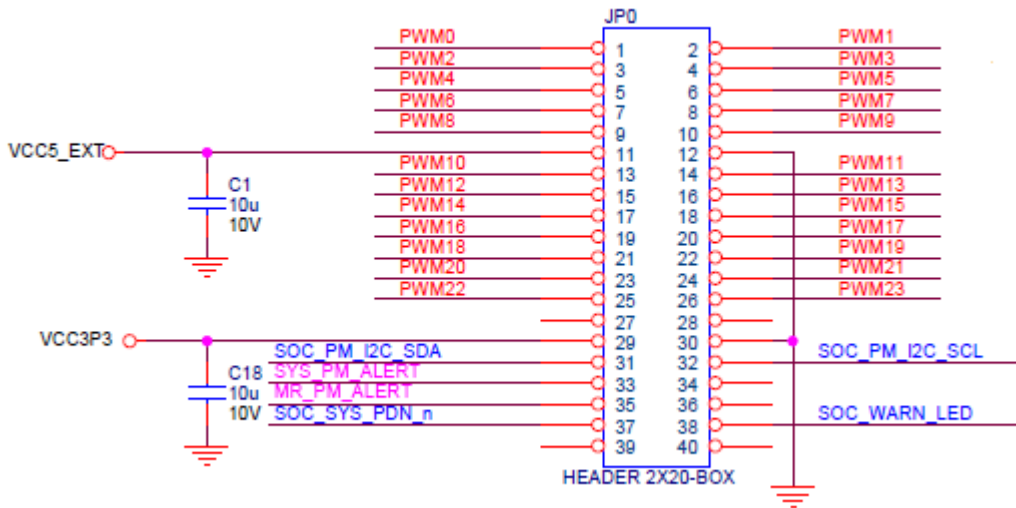

Figure 2-6 2x20 GPIO Pinout

SOC\_PM\_I2C\_SDA and SOC\_PM\_I2C\_SCL are reserved signals. If users want the host FPGA to directly control the power monitor chip INA230, they can remove the two 0 OMH resistor from R310 and R311 to R313 and R314 as shown in Figure 2-7.

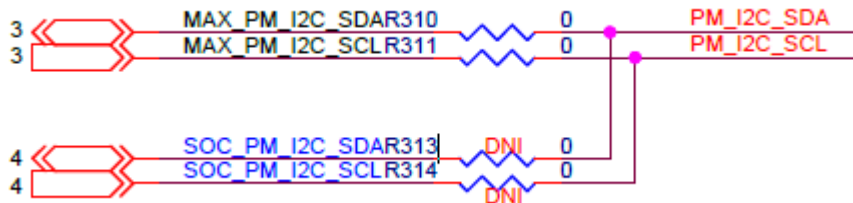

Figure 2-7 SOC\_PM\_I2C\_SDA and SOC\_PM\_IC2\_SCL Signals

The SYS\_PM\_ALERT is an alert signal from the power monitor chip INA230. SOC\_SYS\_PDN\_n is a reserved signal. If users want host FPGA to directly control the daughter power, they can move 0 OMH from R318 to R319 and install the D3 component as shown in Figure 2-8. SOC\_WARN\_LED is a reserved signal. If users want the host FPGA to directly control the warning led, they can move 0 OMH from R316 to R317 as shown in Figure 2-9.

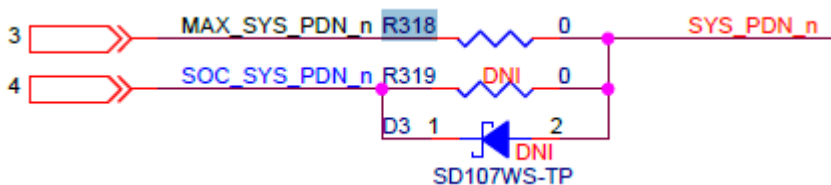

Figure 2-8 SYS\_PDN\_n Signal

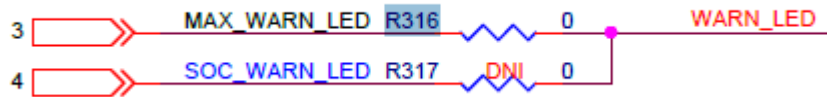

Figure 2-9 WARN\_LED Signal

## 2.6 Interface for Servo Motor

As shown in **Figure 2-10**, the JP1~JP12 provide 24 1x3 pin headers to connect to 24 servo motors. The 24 servo motors are drive by 6V DC power. If developers wish to drive the 5V device, such as an ultrasonic module, they can connect the 5V device to JP12 and set J2.1 and J2.2 short as shown in **Figure 2-11**. In this current example, the 5V device will be driven by 5V coming from the 2x20 GPIO header.

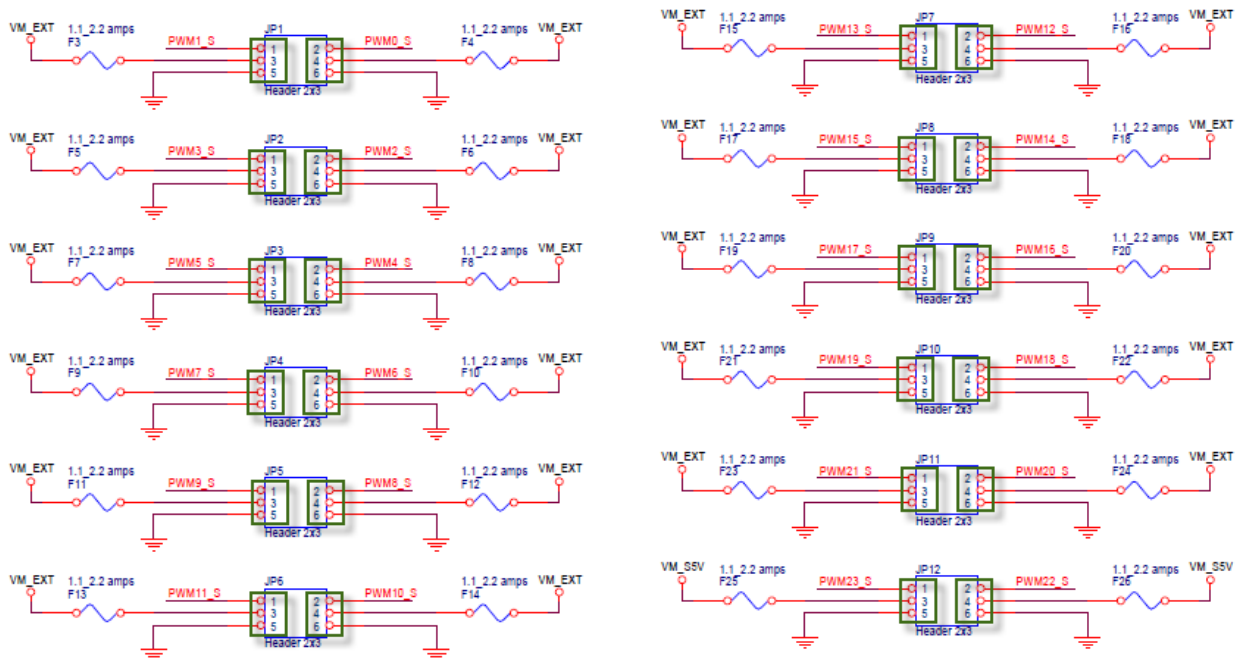

Figure 2-10 24 1x3 header for 24 servo motors

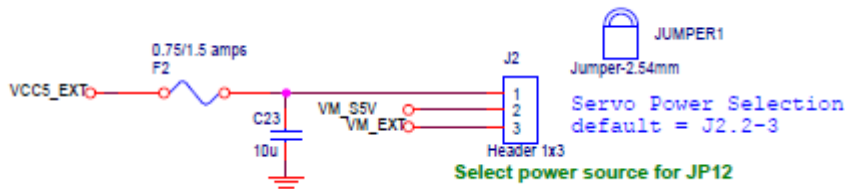

Figure 2-11 JP12 power source selection

## 2.7 CPLD Code for Power Monitor

The power monitor in the motor card is implemented in the CPLD chip as shown in **Figure 2-12**. The source code is available on the System CD. The main function of the CPLD is to turn off power if battery power level is too low or overcurrent is detected. The developer can modify the threshold according to their application. The power is turned off when battery power level is too low in order to prevent battery overcharged. The power is turned off when overcurrent is detected in order to prevent damages in the motor (when servo motor is stuck, power current will increase significantly.).



**Figure 2-12 CPLD for Power Monitor**

## 2.8 Servo Motor Control

The servo motor connector is consistent of three signals as shown in **Figure 2-13**. The red vcc wire and the brown ground wire are used to provide power for the servo motor. The input orange PWM wire is used to specify the rotate angle for the servo motor.

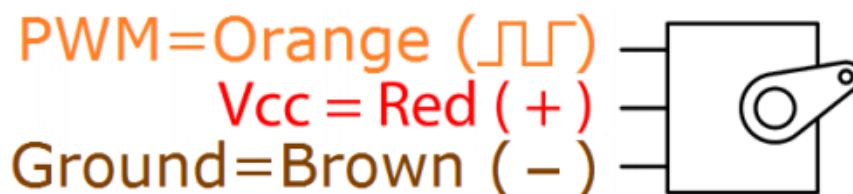

**Figure 2-13 Three wires of server motor connector**

The PWM period should be around 20 ms, and the duty cycle of PWM should determine the rotate angle of the servo as shown in **Figure 2-14**. For the servo motor included in this kit, 0.5 ms duty cycle represents 0 degree, 1.5 ms duty cycle represents 90 degree, and 2.5 ms duty cycle

represents 180 degree as shown in **Figure 2-15**.

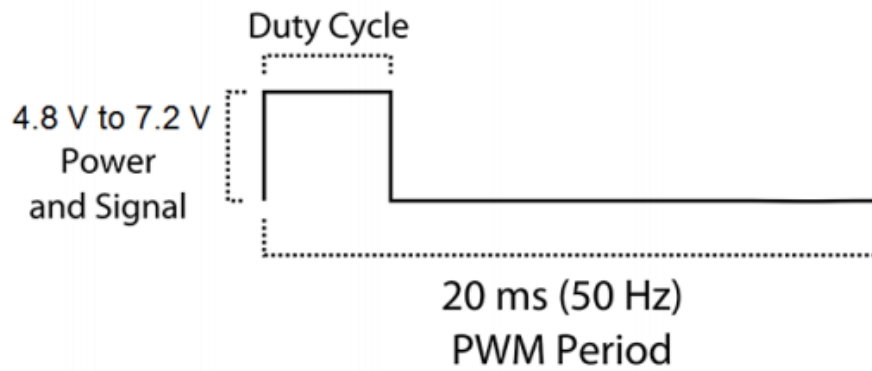

**Figure 2-14 PWM Duty Cycle and Period**

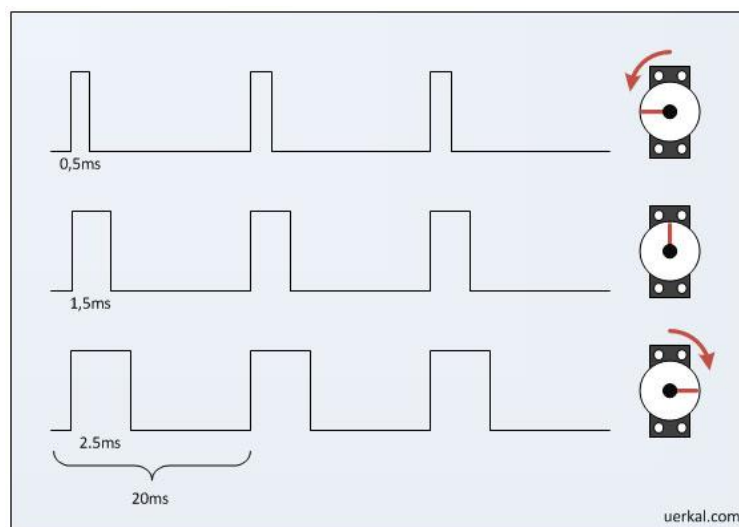

**Figure 2-15 Duty Cycle vs. Angle**

# Chapter 3

## Design Example

This chapter will demonstrate how to control the angle servo motor by PWM signal generated by the FPGA.

### 3.1 Function Block Diagram

**Figure 3-1** shows the Function block diagram of servo motor control demonstration. The FPGA board generate 3.3V PWM signal and send the signal to the Servo Motor Card through GPIO interface. The Server motor will translate the 3.3V PWM signal to 5.0V PWM signal, and send the 5.0V PWM signal to the servo motor. The servo motor will rotate to an angle specified by the duty cyclone of PWM signal as shown in **Figure 2-15** in chapter 2.

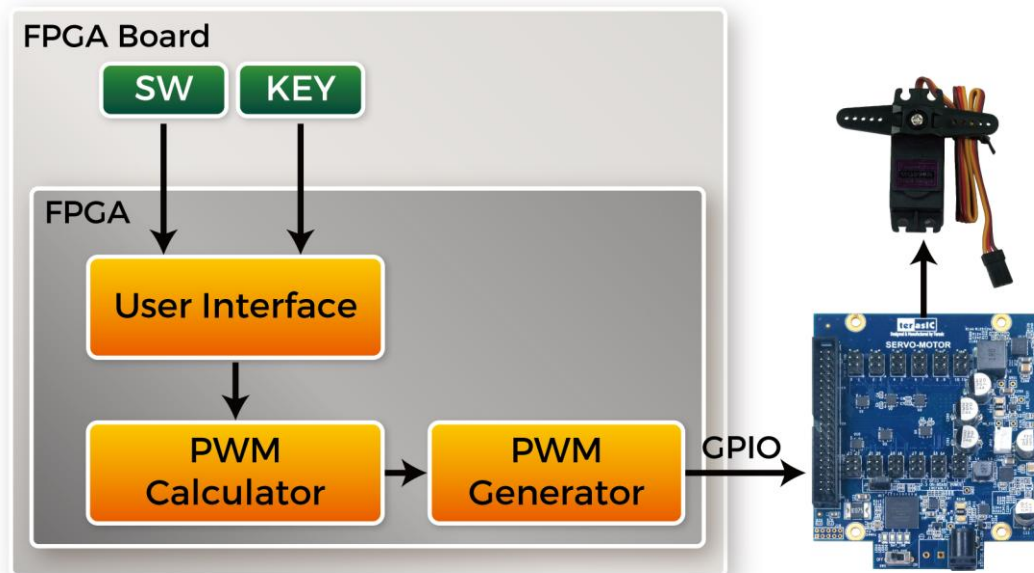

**Figure 3-1** Function block diagram

In this demonstration, users use the KEY and SWITCH on FPGA mainboard to control the behavior of the servo motor. Switches SW [0] and SW [1] are used to set the rotation speed of SERVO, button KEY [0] is used to increase the angle, and button KEY [1] is used to decrease the angle. The User Interface module will initially send the inputted angle to the PWM (Pulse Width Modulation) Calculator module for calculations. After the PWM Calculator has converted the angle into pulsing signals, the signals are sent to a PWM Generator module. Finally, the PWM Generator module will output PWM signals to the GPIO header to drive the servo.



## 3.2 Demo Setup

### ■ Design Tools

Quartus II v15.1  
Nios II Eclipse 15.1

### ■ Demonstration Source Code

Quartus project directory: DE0-CV\_SMK  
Nios II Eclipse project workspace: DE0-CV\_SMK\software

### ■ Demonstration Batch File

Demo batch file folder: demonstrations\DE0-CV\_SMK\demo\_batch

### ■ Demonstration Setup for DE0-CV

Please follow the procedures below to setup the demonstration as shown in **Figure 3-2**.

1. Power off the servo motor card.
2. Connect servo motor to the **PWM0** on the servo motor card.
3. Connect the GPIO0 output of the DE0-CV board to the servo motor card.
4. Plug 12V DC to the servo motor card.
5. Power on the servo motor.
6. Connect a USB cable between the host PC and the USB connector (J3) on the DE0-CV.
7. Please make sure Quartus II has been installed on the host PC.
8. Execute the batch file “test.bat” under the demo\_batch folder of DE0\_CV\_SMK project.
9. Press KEY0 to increase servo angle.
10. Press KEY1 to decrease servo angle.
11. Adjust the speed by SW0 SW1.

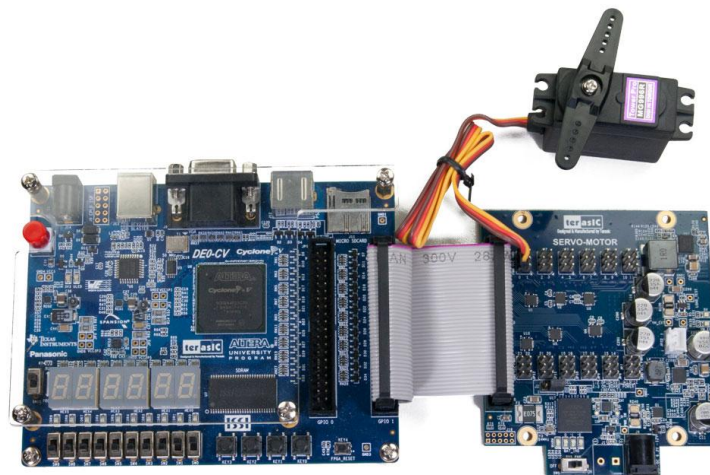
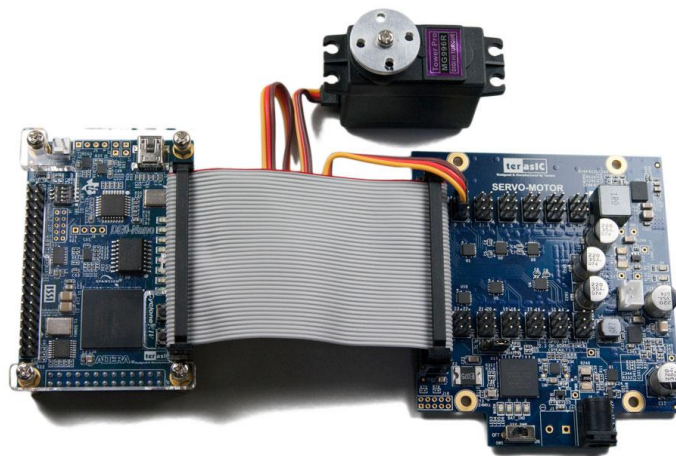

**Figure 3-2 Demo Setup with DE0-CV**

## ■ Demonstration Setup for DE0-Nano

Please follow the procedures below to setup the demonstration as shown in **Figure 3-3**

1. Power off the servo motor card.
2. Connect servo motor to the **PWM2** on the servo motor card.
3. Connect the GPIO0 output of the DE0-Nano board to the servo motor card.
4. Plug 12V DC to the servo motor card.
5. Power on the servo motor.
6. Connect a USB cable between the host PC and the USB connector on the DE0-Nano.
7. Please make sure Quartus II has been installed on the host PC.
8. Execute the batch file “test.bat” under the demo\_batch folder of DE0\_Nano\_SMK project.
9. Press KEY0 to increase servo angle.
10. Press KEY1 to decrease servo angle.
11. Adjust the speed by SW0 SW1.



**Figure 3-3 Demo Setup for DE0-Nano**

