

Data Sheet

LL01ZZ-AAAxL49



VERO13



■ Features & Typical Applications

- High efficiency
- Available with 3 beam angles
- Optimized Uniformity
- Lens without Holder
- Architectural Lighting
- Downlight

■ Table of Contents

General Information & Product Nomenclature.....	P.2
Optical Specifications	P.3
Mechanical Specifications	P.4
Package Specifications.....	P.5

LL01ZZ-AAAxxL49

General Information

- Reflector Material : Aluminum
- Operating Temperature range -40°C~+110°C(upper limit +120°C).
- Storage Temperature range -40°C~+110°C(upper limit +120°C).
 - * Average transmittance in visible spectrum 400nm~700nm>90%.
- Usage and Maintenance:
 1. If necessary, clean lenses with mild soap, water and soft cloth.
 2. Never use any commercial cleaning solvents on lenses, like alcohol.
 3. Please handle or install lenses with wearing gloves, skin oils may damage lens or its optical characteristic.

Product Nomenclature

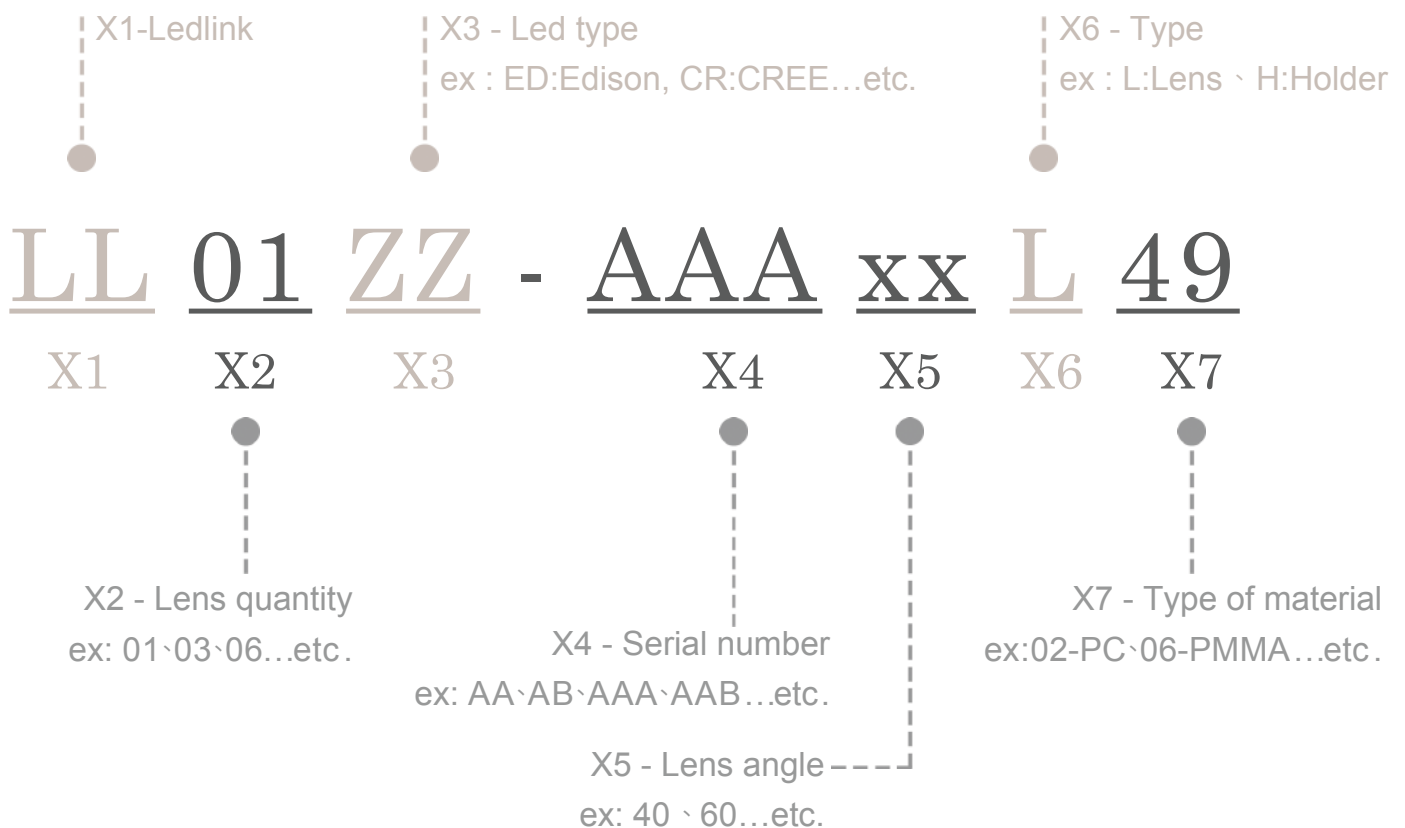

LL01ZZ-AAAxxL49

Optical Specifications



VERO13

Note: (1) All the results of analysis are based on 0 degrees of elevation.
 (2) Tolerance: $\pm 10\%$.
 (3) Led Luminous Flux(lm): 856($\pm 5\%$).

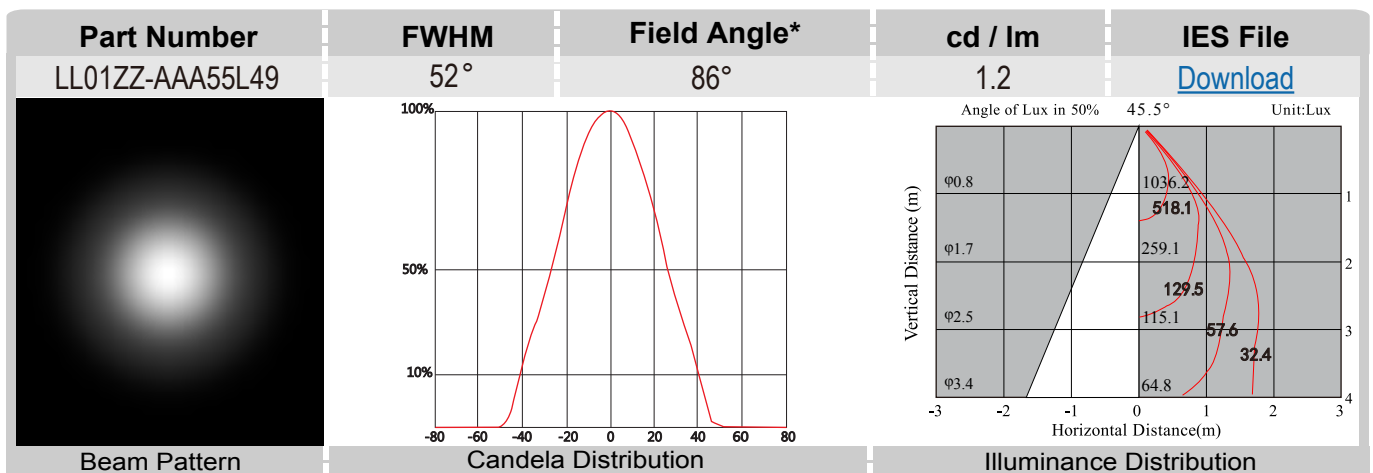
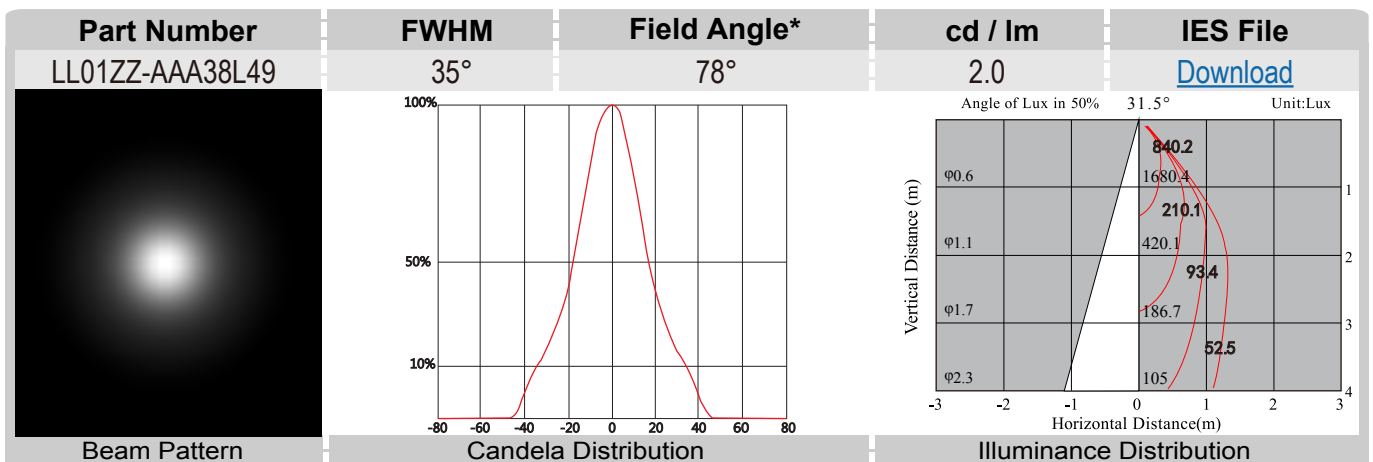
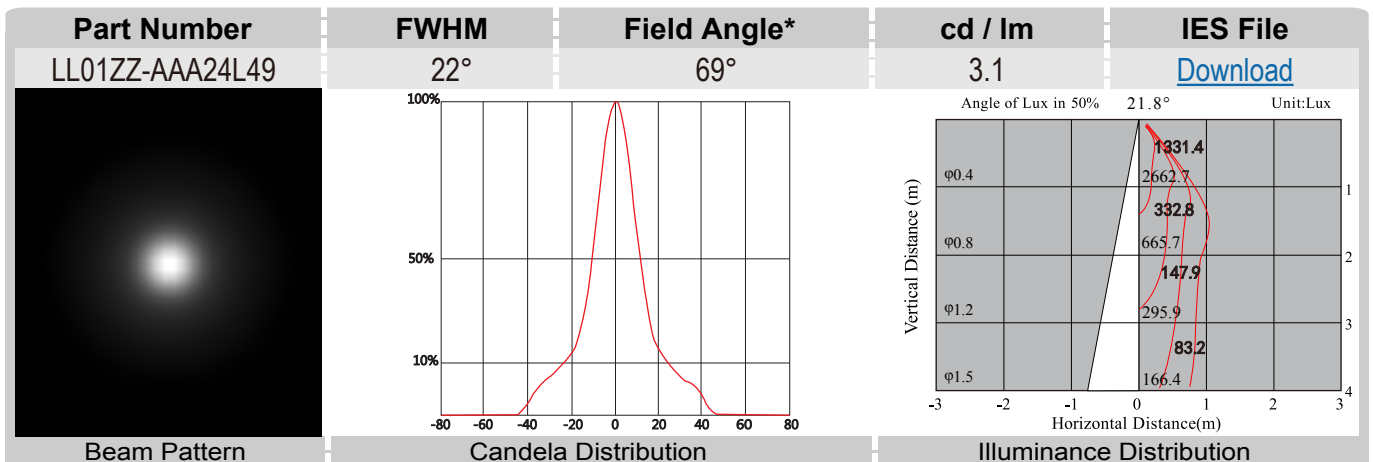

*The Field Angle is the angle between the two directions opposed to each other over the beam axis for which the luminous intensity is 10% that of the maximum luminous intensity.
 *This testing result is obtained through testing the popular rank LED samples which provided by the original manufacturer. Hence, the testing results would be varied as the users choose same LED model but different rank.

LL01ZZ-AAAxL49

Mechanical Specification

1. Fixing method

- Glue
 Screw
 Tape
 Fixing-ring
 Frame

Note: (1) All dimensions are in mm.
 (2) All tolerance are ± 0.15 mm unless otherwise specified.

2. Lens dimension

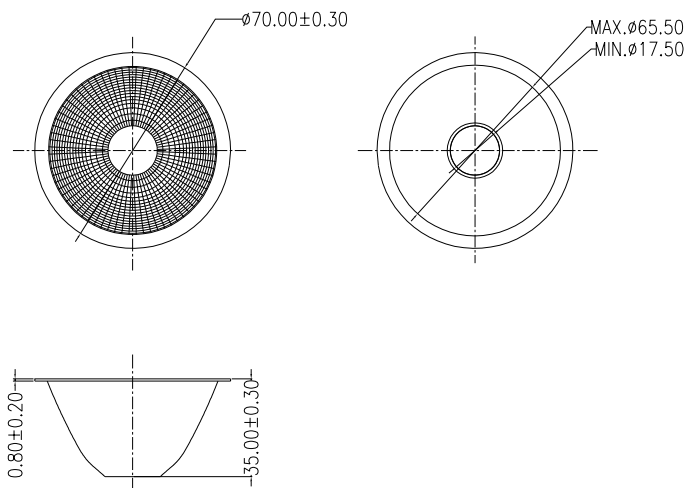

3. Lens + Leds assembly instruction



4. Holder dimension

5. View assembly lens with LED:

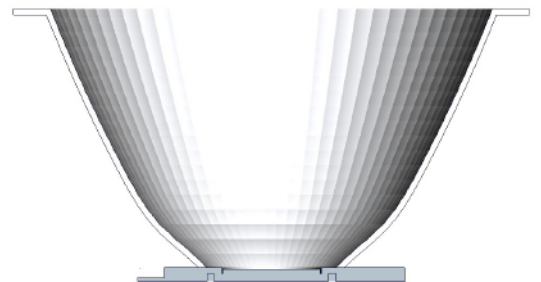

LL01ZZ-AAAxL49

Package Specifications

Item	Quantity	Total	Size(L*W*H)	G.W
EPE stack	7 pcs/EPE stack	7 pcs		11g
outer box	9 stack/outer box	63 pcs	25*22.5*15 cm	

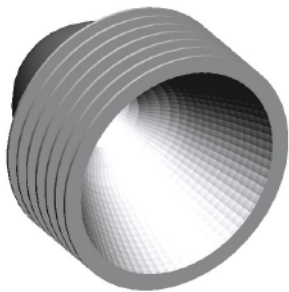

7 pcs/plastic box

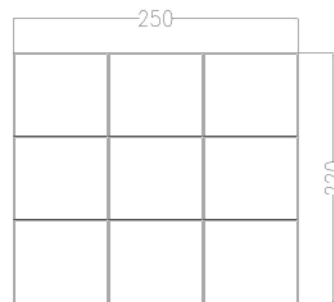

63 pcs/outer box



Note: