

**16 Pole  
with Ground**  
PROTECTION  
**IP65**  
RATING



**Component  
Parts**

**Pre-Assembled Units**

**Covers**

**Bulkhead Housing**

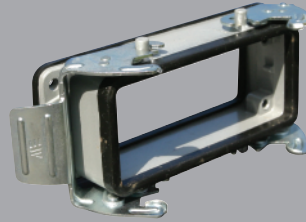

29042

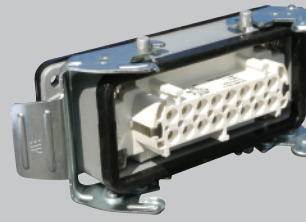

403030

**FEMALE  
Insert**

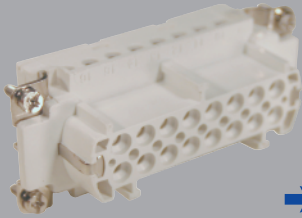

29022

**Hood**



29050  
29050M



403035  
403035M



29651

**Surface Mount  
Housing**

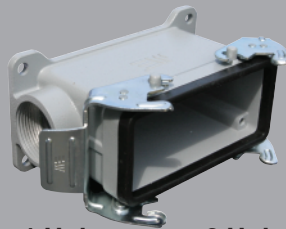

**1 Hole** 29056  
29056M     **2 Hole** 29057  
29057M



**1 Hole** 403036  
403036M     **2 Hole** 403038  
403038M

Standard Part Numbers are  
NPT threads.  
Part numbers with an "M"  
are metric thread.

**MALE  
Insert**

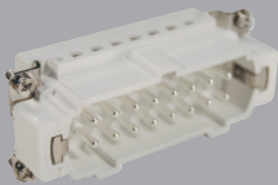

29023

**Hood**



29043  
29043M



403033  
403033M

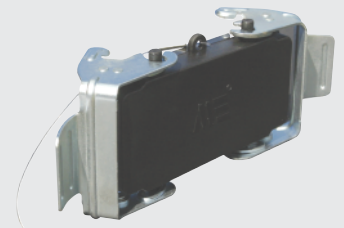

29654



Connectors should not be coupled  
and decoupled under electrical load.

**Inserts**

Number of contacts	16 Pole w/ ground
Electrical data to DIN EN61 984	16A 400V 6KV 3
Current	16A
Voltage	400V
Rated Impulse Voltage	6KV
Insulation Resistance	≥10 <sup>10</sup> Ω
Temperature Range	-40 to 125°C
Flammability	UL94-V0

**Contacts**

Screw terminal	
Material	Copper alloy
Surface plated	hard-silver
Contact resistance	≤ 1m Ω
Wire size	2.5mm <sup>2</sup> / 14 AWG
Torque	0.5Nm
Stripping Length	7.5mm

**Metal Hoods & Housings**

Material	Aluminum
Surface	Powder coated
Seals	NBR
Degree of Protection Acc To	
DIN EN60529 for coupled connectors	IP65
Thread Size	NPT 3/4" or M25

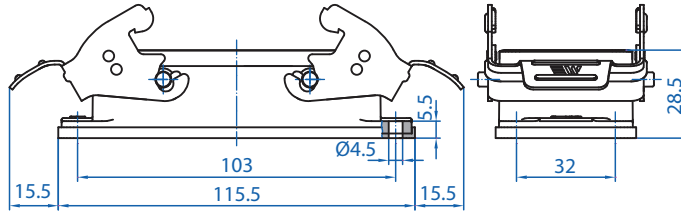

29042

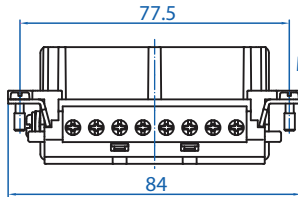

29022

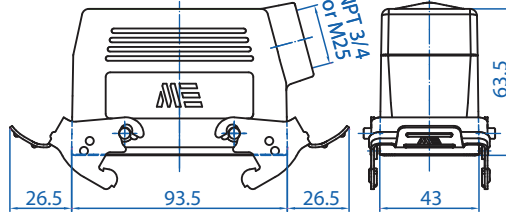
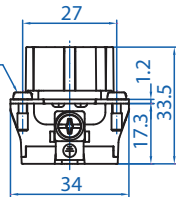

29050

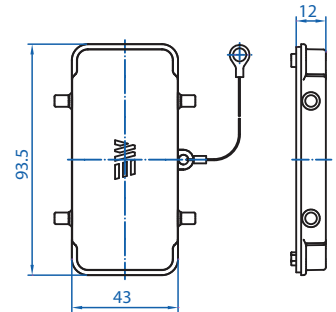

29651

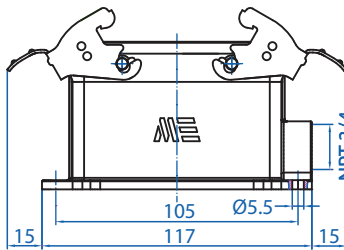

29056

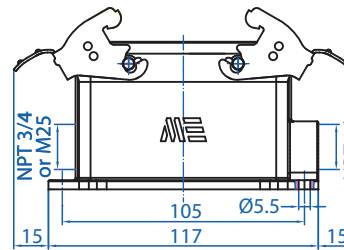
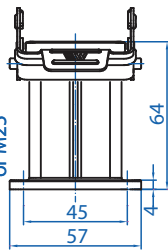

29057

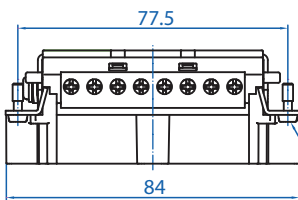
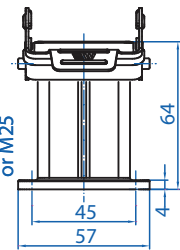

29023

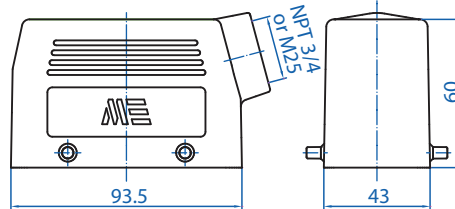
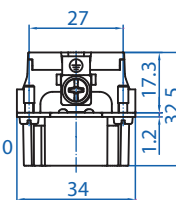

29043

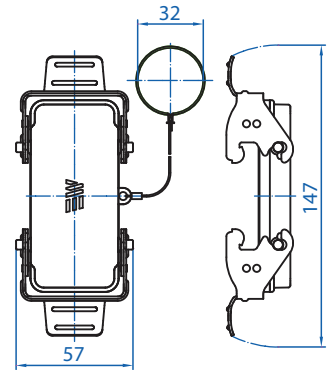

29654



Connectors should not be coupled and decoupled under electrical load.

All dimensions are shown in millimeters. To convert to inches divide by 25.4.