

PART NUMBER	NO. OF MOD.
10026155-005	1
10026155-005LF	

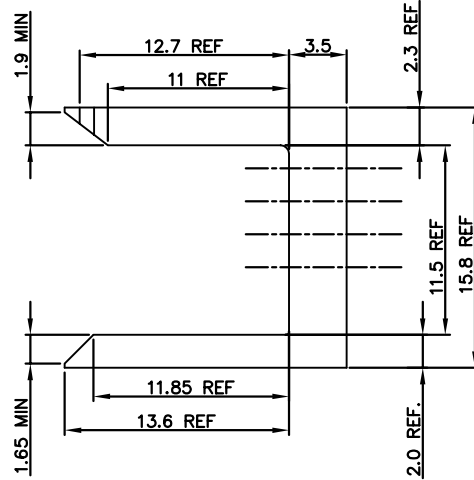

NOTES:

1. BODY MATERIAL: LIQUID CRYSTAL POLYMER 30% GLASS. FLAME RETARDANT ACC. TO UL 94-V0. COLOR: NATURAL
2. FOR LEAD FREE NUMBERS, ADD AN 'LF' SUFFIX. PART NUMBERS THAT DO NOT END IN 'LF' ARE LEAD FREE. EXAMPLE: 10026155-005LF
3. THE PRODUCTS WHERE THE PART NUMBER ENDS IN LF AND THE NONE LF PART NUMBERS MEET THE EUROPEAN UNION DIRECTIVES AND OTHER COUNTRY REGULATIONS AS DESCRIBED IN GS-22-008.
4. ALL PRODUCTS WILL WITHSTAND EXPOSURE TO 260°C FOR 60 SECONDS IN A CONVECTION, INFRA-RED OR VAPOUR PHASE REFLOW OVEN.

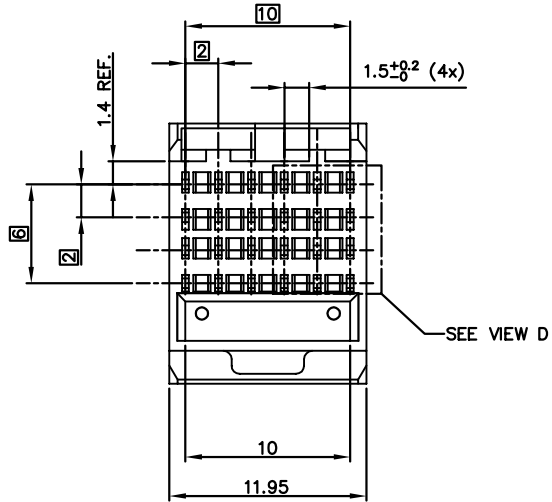
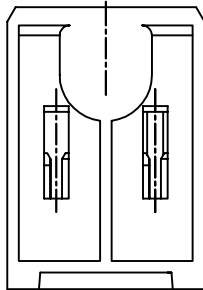
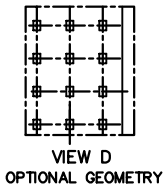

mat'l. code		surface		tolerance		projection		product family				
SEE NOTE 1		ASME Y14.5		ASME Y14.5				METRAL (tm)				
ltr	ecn no	dr	date	tolerances unless otherwise specified				title				
A	V03-0335	LP	03/21/03	angles	Linear	.X±.3	MM		4 ROW SHROUD			
B	V03-0439	LP	4/22/03			.XX±.13						
C	V06-0080	JRV	3/15/06	0°±2°		.XXX±.051	scale 1:1					
D	V06-0609	DCH	2008-06-22	dr	L.POTTEIGER	03/21/03			dwg no	sheet 1 of 2	size	
				engr	M.GRAY	03/21/03			10026155	A4		
				chr	M.GRAY	03/21/03						
				appd	M.GRAY	03/21/03			type		CUSTOMER Drawing	
sheet index	revision sheet	D	D									
	1	2										

PART NUMBER	DIM A	DIM B	NO. OF MOD.
10026155-001	35.95	34.00	3
10026155-002	23.95	22.00	2
10026155-003	47.95	46.00	4
10026155-004	95.95	94.00	8
10026155-001LF	35.95	34.00	3
10026155-002LF	23.95	22.00	2
10026155-003LF	47.95	46.00	4
10026155-004LF	95.95	94.00	8

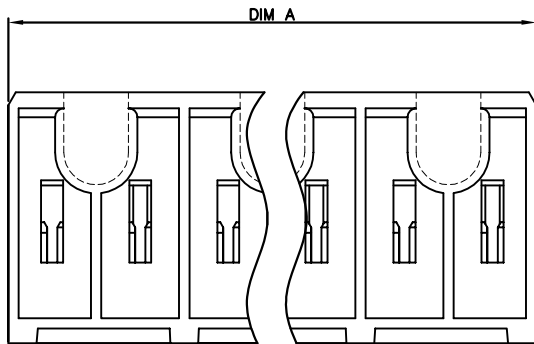
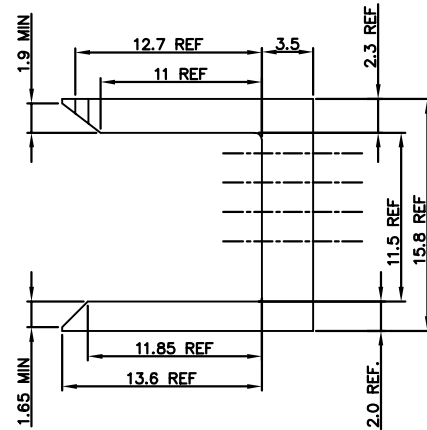
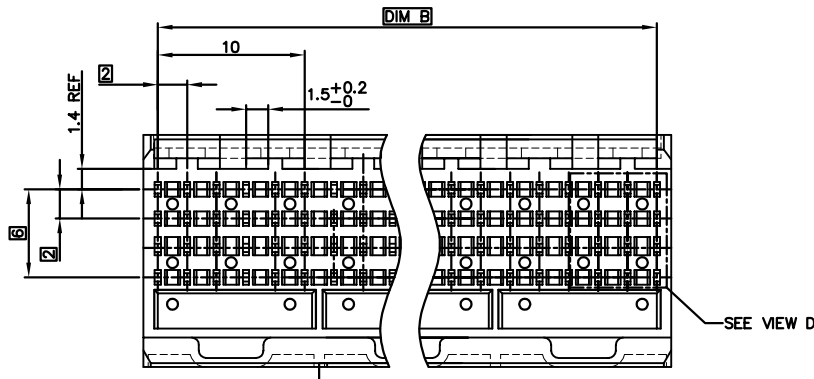

mat'l. code SEE NOTE 1		surface ASME Y14.5	tolerance ASME Y14.5	projection 	product family METRAL (tm)
ltr	ecn no	dr	date	tolerances unless otherwise specified	title 4 ROW SHROUD
D				angles .X±.3 .XX±.13 0°±2'	MM scale 1:1
		dr	L.POTTEIGER 03/21/03		dwg no 10026155
		engr	M.GRAY 03/21/03		sheet 2 of A4
		chr	M.GRAY 03/21/03		type CUSTOMER Drawing
		app	M.GRAY 03/21/03		
sheet index	revision sheet				