

**SMA ATTENUATOR**

**R411.804.124**

**4 DB 6 GHZ 1W**

Series : ATTENUATOR

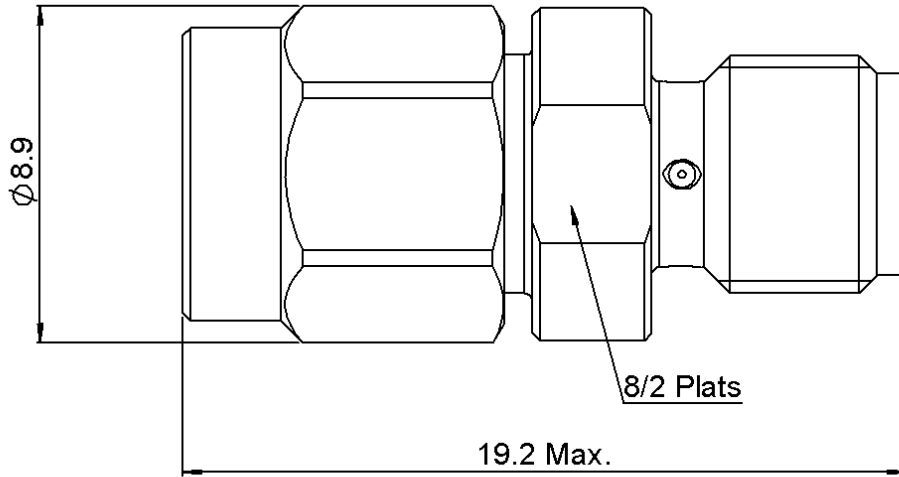

SCALE 1/1

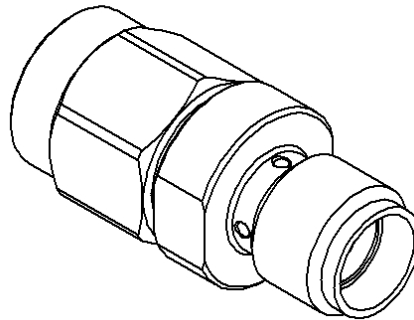

All dimensions are in mm.



COMPONENTS	MATERIALS	PLATING(μm)
BODY	BRASS	NICKEL 2
MALE CENTER CONTACT	BRASS	.GOLD 1 OVER NICKEL 2
FEMALE CENTER CONTACT	BERYLLIUM COPPER	.GOLD 1 OVER NICKEL 2
OUTER CONTACT		
INSULATOR	PTFE	
GASKET	SILICONE RUBBER	
SUBSTRATE	ALUMINA	
RESISTOR	THICK FILM	
OTHERS PARTS		

Issue : 0740 C

In the effort to improve our products, we reserve the right to make changes judged to be necessary.

**SMA ATTENUATOR**

**R411.804.124**

**4 DB 6 GHZ 1W**

Series : ATTENUATOR

**ELECTRICAL CHARACTERISTICS**

Frequency (GHz)	DC - 2	2 - 6
V.S.W.R (≤)	1.20	1.30
Deviation(±dB)	0.30	0.50

Operating Frequency Range	DC - 6	GHz
Impedance	50	Ω
Nominal Attenuation	4	dB
Peak power at 25°C (1μs, 1%)	100	W
Average power at 25°C	1	W (Free Air Cooled) W (Conduction Cooled)

**MECHANICAL CHARACTERISTICS**

Connectors	SMA	Male Female	MIL-C 39012
Weight	4,3200	g	

**ENVIRONMENTAL CHARACTERISTICS**

Operating temperature range	-40 / +85 °C
Storage temperature range	-40 / +85 °C



**SPECIFICATION**

**OTHER CHARACTERISTICS**

Issue : 0740 C

In the effort to improve our products, we reserve the right to make changes judged to be necessary.