

KEMET Part Number: SSHB21HS-R05910
(UALSB2SR059100)

KEMET, SSHB21HS, AC Line Filters, Dual Mode, 0.091 H

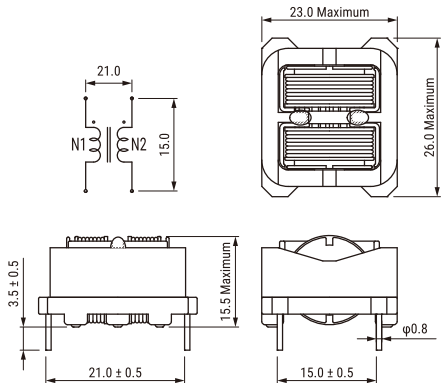

Dimensions

L	26mm MAX
T	23mm MAX
H	15.5mm MAX
LL	3.5mm +/-0.5mm
S	21mm +/-0.5mm

Packaging Specifications

Packaging:	Tray
Packaging Quantity:	360
Weight:	14 g

General Information

Series:	SSHB21HS
Style:	Through-Hole
RoHS:	Yes
Notes:	Marking: R05 Lot No.
Miscellaneous:	Temperature Rise Maximum: 55 K

Specifications

Voltage AC:	250 VAC
Inductance:	91 mH (10 kHz)
Current:	500 mA
Temperature Range:	-25/+120°C
DC Resistance:	1.88 Ohms