



# Trackpad Development Kit User Guide

Using Arduino-Compatible Teensy 3.2 Hardware

Version 1.0

MAY 2017



## Document Version History

Date	Current Version	Description
MAY 2017	1.0	Initial Document Creation

### Notice

This document is the sole property of Cirque Corporation. The information contained within is proprietary to Cirque Corporation. The holder of this document shall treat all information contained herein as confidential, shall use the information only for its intended purpose, and shall protect the information in whole or in part from duplication, disclosure to any other party, or dissemination in any media without written permission from Cirque Corporation.

**Note to Purchasers:** All specifications subject to change without notice. Cirque shall not be liable for any damages whether non-specified, direct, indirect, special, incidental or consequential (including downtime, loss of profit or goodwill) regardless of the legal theory asserted. This document supersedes all previous versions.

### Copyright, Trademark, and Patent Information

Copyright © 2017 Cirque Corporation. All Rights Reserved. Cirque®, the Cirque logo, GlidePoint® and the GlidePoint are trademarks of Cirque Corporation. All other brand names or trademarks are the property of their respective owners.

Cirque's touch controller platforms and technology solutions are protected by patents and additional U.S. and International patents pending. Contact Cirque for more information.

# Table of Contents

---

<b>Table of Contents .....</b>	<b>3</b>
<b>Overview and Set Up.....</b>	<b>4</b>
<b>Prerequisites .....</b>	<b>4</b>
<b>Installing the Development Environment.....</b>	<b>4</b>
<b>Setting up the Hardware.....</b>	<b>5</b>
<b>Connection Details .....</b>	<b>7</b>
<b>Running the Trackpad Sketch .....</b>	<b>8</b>
<b>Contact Information .....</b>	<b>12</b>
<b>Appendix A – Development Board Schematic .....</b>	<b>13</b>
<b>Appendix B – Teensy Board Pin Out.....</b>	<b>15</b>

# Overview and Set Up

---

This document will describe how to get up and running with the Cirque circle sensor development kit. This kit utilizes a hardware platform based on Arduino<sup>1</sup> for easy development.

## Prerequisites

At a minimum, the following components are required:

- PC (Windows or Mac OS) with available USB port.
- Cirque GlidePoint Dev Board (p/n: 02-000620-00). This board should have the Teensy 3.2 Arduino compatible module pre-mounted. If this Teensy 3.2 is not pre-mounted it will need to be attached to the board using pluggable header pins (see Figure 1).
- Cirque trackpad modules with 12-pin connector (for example, the TM040040 Pinnacle Circle Trackpad).
- USB-micro cable for connecting the Teensy 3.2 to the computer.
- 12-pin flat flex cable for connecting the trackpad to the dev board.
- Optional circle sensor holder.

Certain development kits from Cirque, such as the Circle Trackpad Dev Kit (p/n: DK-000013-xx), provide a complete package with these components. Contact a Cirque sales representative for details on how to obtain a development kit.

## Installing the Development Environment

1. If not already installed, you must download and install the Arduino IDE:
  - a. Arduino IDE Download Link: <https://www.arduino.cc/en/Main/Software>
  - b. The Arduino IDE does not support the Teensy development board by default. It will be necessary to install a plug-in called “Teensyduino” for Teensy support.
    - i. Teensyduino Download Link: [https://www.pjrc.com/teensy/td\\_download.html](https://www.pjrc.com/teensy/td_download.html). Follow the instructions on this page for the installation of Teensyduino for your operating system.
    - ii. **NOTE:** The Teensyduino installer modifies the Arduino IDE installation, which may cause some anti-virus programs to flag it as malicious. It may be necessary to disable anti-virus software prior to this installation.
2. Next you will need to download the example code file for the trackpad you are using. Cirque makes example code available at GitHub (<https://github.com/cirque-corp>). For a direct link to the specific project you are working on, consult the documentation or the web page for that trackpad. For example, a link to the Circle Trackpad GitHub sample code can be found at <http://www.cirque.com/glidepoint-circle-trackpads>. You will need to locate the specific .ino file for the trackpad project you are working on. Arduino uses the file extension

---

<sup>1</sup> Arduino is a trademark of Arduino AG.

“.ino” for source files. These files are text-only and contain C/C++ source. These are also called sketches” in Arduino terminology.

## Setting up the Hardware

1. If your dev kit came with a trackpad holder, you may attach it to the development board for ease of use. The holder attaches to the mounting holes in the corner of the dev board. There may be a second smaller piece that connects to the other side to help level the board (see below). The use of this holder is optional, but it will assist with the orientation of the trackpads during development.

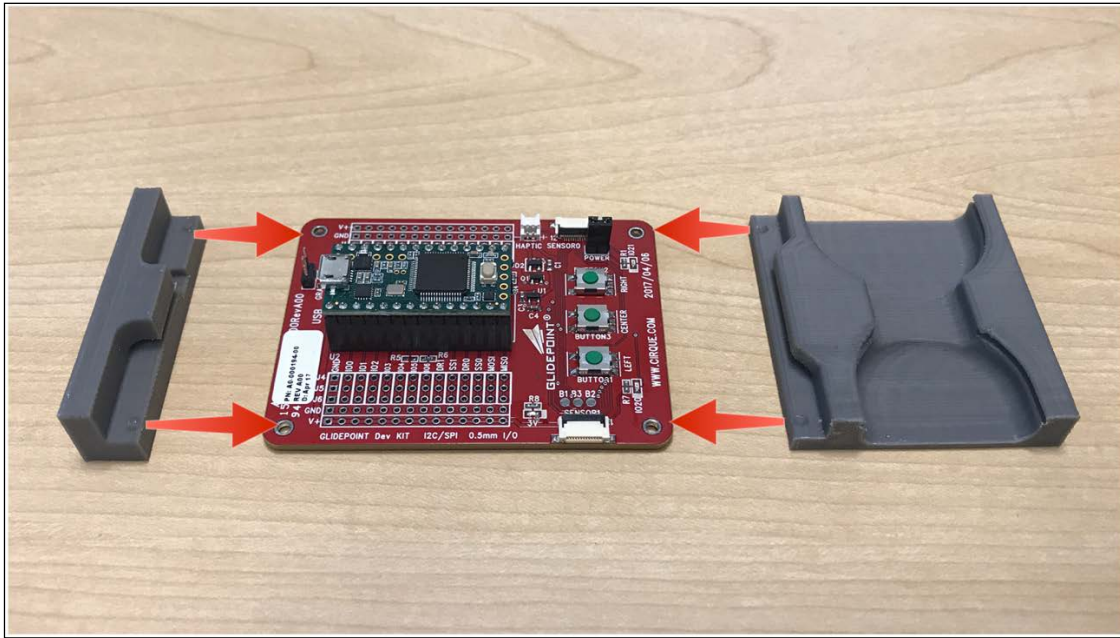

Figure 1: Slide the holder so that it clips into the corner mounting holes as shown above.

2. Next, connect one or more trackpad modules to the development board. Insert the 12-pin flat flex cable (FFC) to the connector on the trackpad with the cable conductors facing down, then fold the latch down to lock it in. NOTE: The sample code provided by Cirque only provides support for ONE sensor and it must be connected to the SENSOR\_0 connector. Support for two sensors is coming soon.

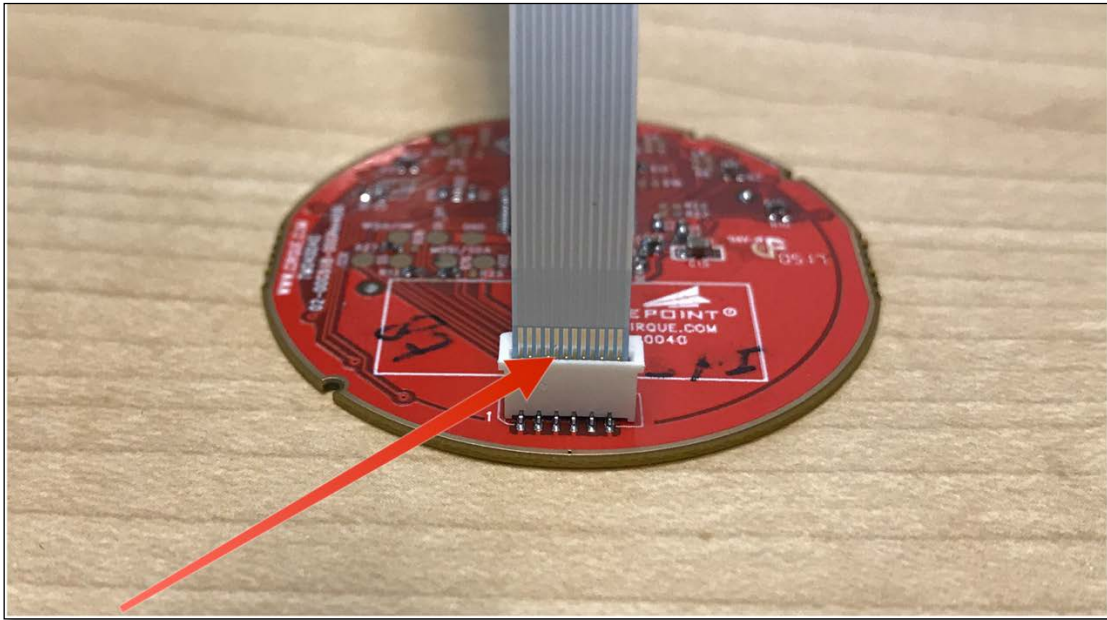

Figure 2: Note the orientation of the exposed FFC conductors.

3. On the development board the FFC connects to the SENSOR0 and SENSOR1 connectors. Note that the exposed conductors should be facing downward on this side of the connection as well.

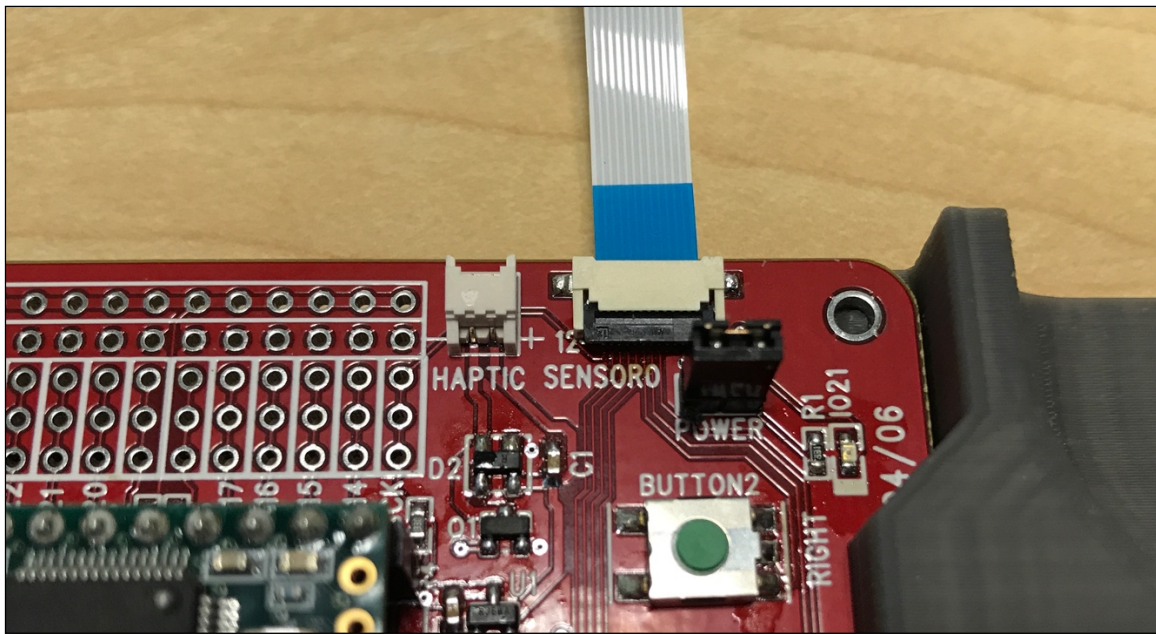

Figure 3: Connection to the development board.

## Connection Details

The full schematic for the development board can be found in Appendix A. Key details can be found below. Connections for both SPI and I<sup>2</sup>C trackpads are supported.

*Table 1: SENSOR0 Pin Out*

1	2	3	4	5	6	7	8	9	10	11	12
3.3 V*	GND	SDA	SCL	BTN1	BTN3	BTN2	MOSI	DR0**	SS0**	MISO	SCK

*Table 1: SENSOR1 Pin Out*

1	2	3	4	5	6	7	8	9	10	11	12
3.3 V	GND	SDA	SCL	BTN1	BTN3	BTN2	MOSI	DR1**	SS1**	MISO	SCK

**\*NOTE:** A header for the power connection on SENSOR0 is provided so that developers can monitor power consumption (labeled POWER). Check to ensure that the jumper is in place to properly power SENSOR0.

**\*\*NOTE:** For the purposes of identifying the correct trackpad module, pins 9 and 10 are used (DATA READY and SLAVE SELECT). It will be necessary to target the correct module (either 0 or 1) in the sample code.

*Table 3: HAPTIC Pin Out*

1	2
PLUS	MINUS

A connector is made available for experimenting with haptic devices such as the Alps® HAPTIC™ Reactor. For full details see the schematic in Appendix A.

**NOTE:** Do not exceed 80 mA current on the haptic connector.

# Running the Trackpad Sketch

Once the hardware is assembled and the Arduino software has been installed you are ready to connect the hardware to a computer to begin communicating with the trackpad.

The example below will use a sketch that outputs X, Y, Z data over a serial port monitor to the computer.

1. Connect the dev board to the computer using a USB to Micro USB cable.
2. Open the Arduino IDE
3. Open the example code “sketch” (.ino file) you want to load.
4. Check to make sure that the Teensy 3.2 is selected under the “Tools > Boards” menu.
5. Check to make sure CPU Speed is set to “96 MHz (overclock)”

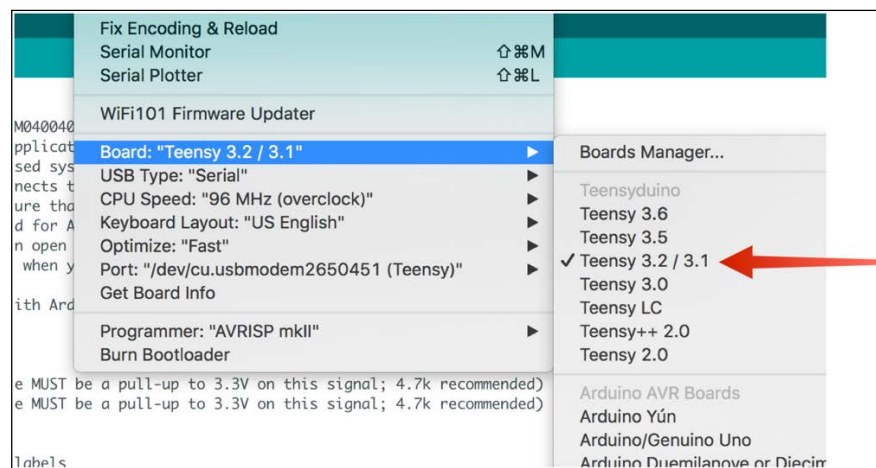

6. Click the “Verify” button to check the code and compile it. Then select “Upload” to program the Teensy board. Once the upload is complete, press the white button on the Teensy 3.2 module to force a program-load (this is the only way to ensure new code is uploaded) NOTE: the first time compiling the code may take a while. Subsequent compilations are much faster. Also note that an additional window will open showing the TeensyLoader window which will also direct you to push the white button on the Teensy module.





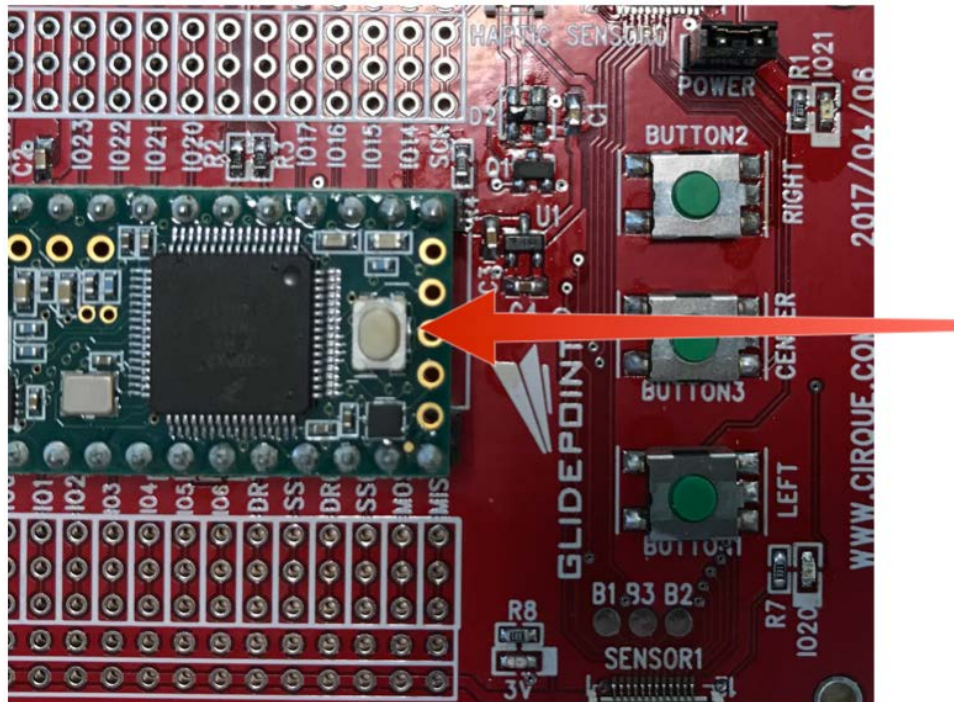
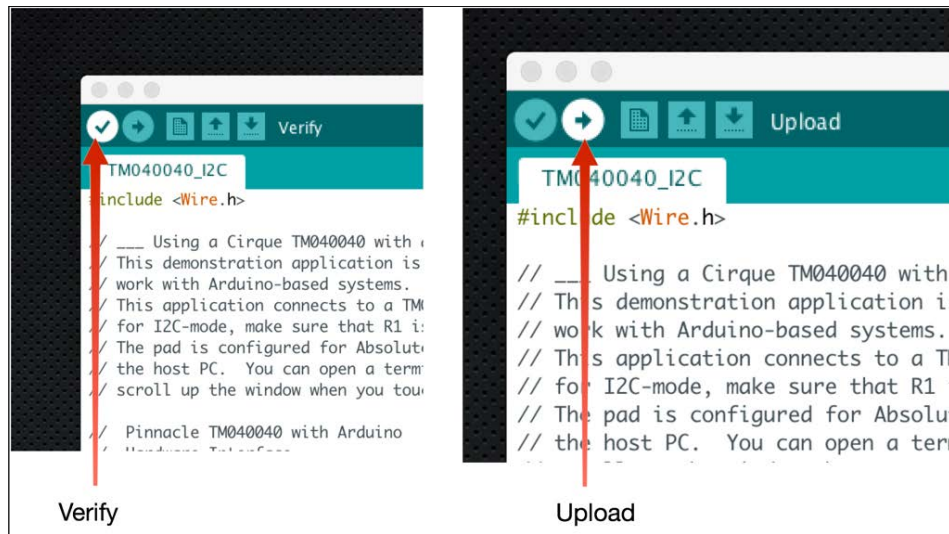

7. Once the loading is complete, select Tools > Port and make sure that the Teensy is selected as the serial port.

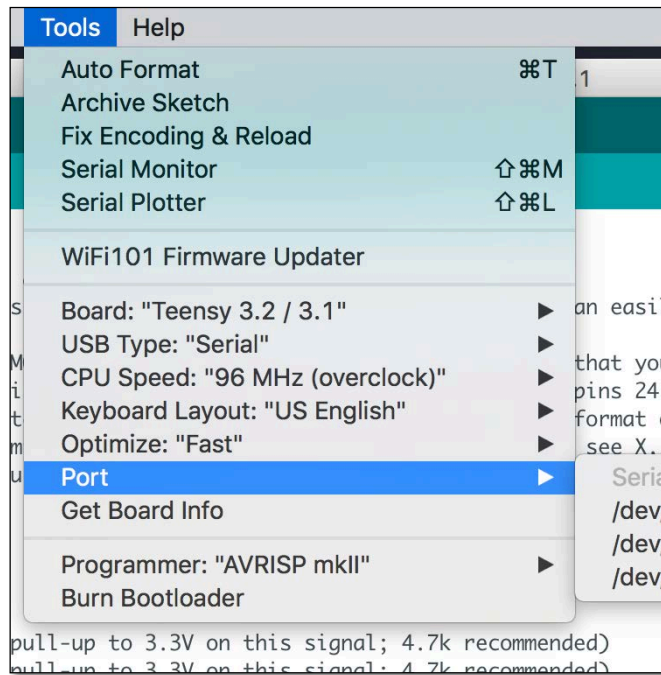

8. Next, select Tools > Serial Monitor.

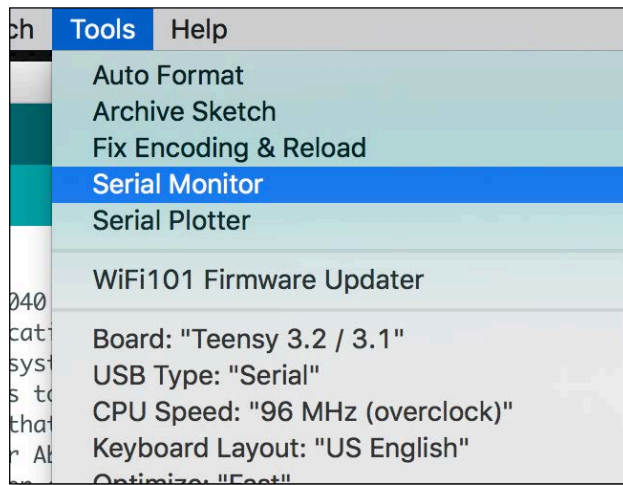

9. This will open the serial monitor window. In the example sketch, X,Y,Z data packets are displayed in this window. You may want to select "Autoscroll" so that the most current information is always displayed in the window. NOTE: any serial monitor software should work. Because this device enumerates as USB CDC, the "baud rate" settings have no effect.



# Contact Information

---

Contact a Cirque sales representative for a technical support or a complete list of Cirque's OEM products.

Website:	<a href="http://www.cirque.com">www.cirque.com</a>
In the United States and Canada:	<b>(800) GLIDE-75 (454-3375)</b>
Outside US & Canada:	<b>(801) 467-1100</b>
Fax:	<b>(801) 467-0208</b>

# Appendix A – Development Board Schematic

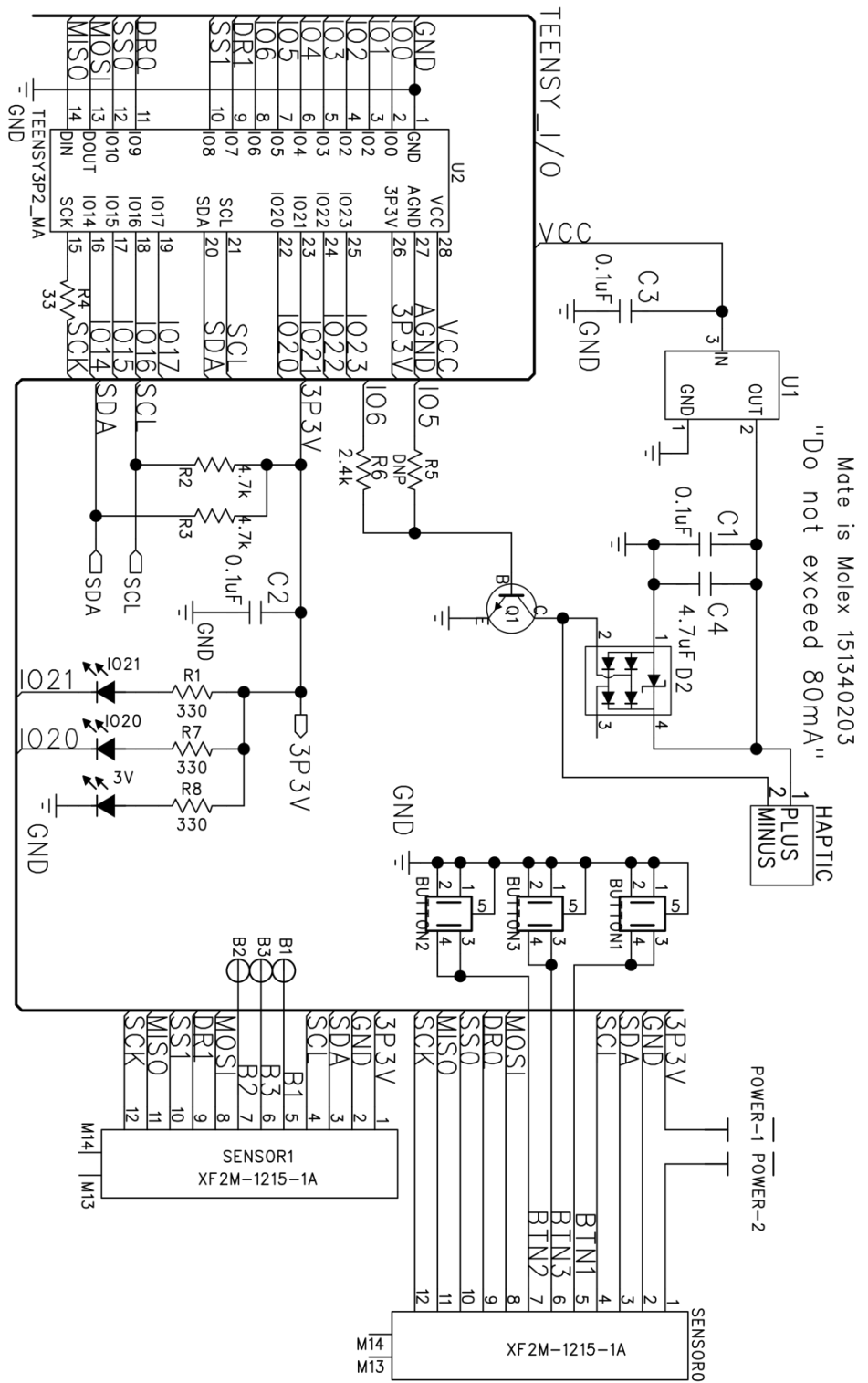

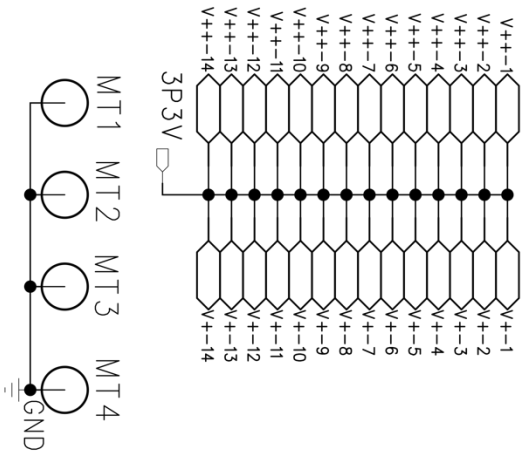
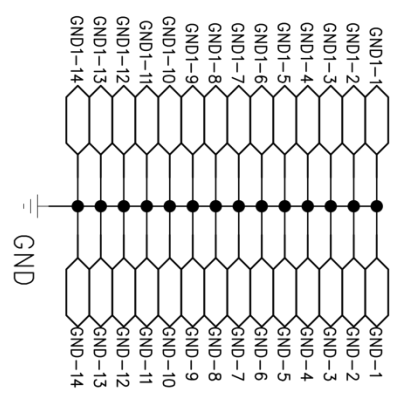
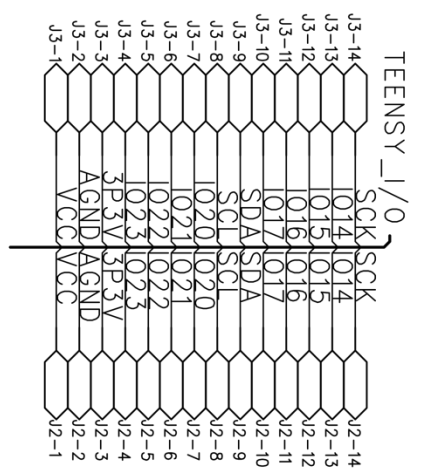
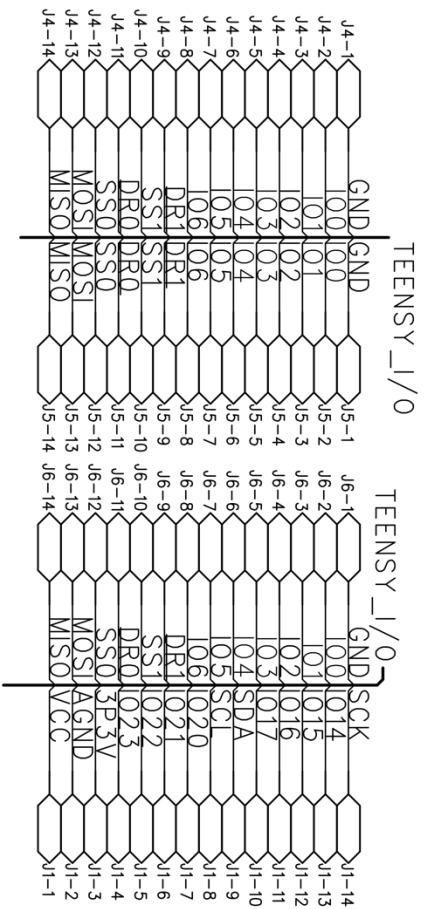



## Additional pins and features available on the back side

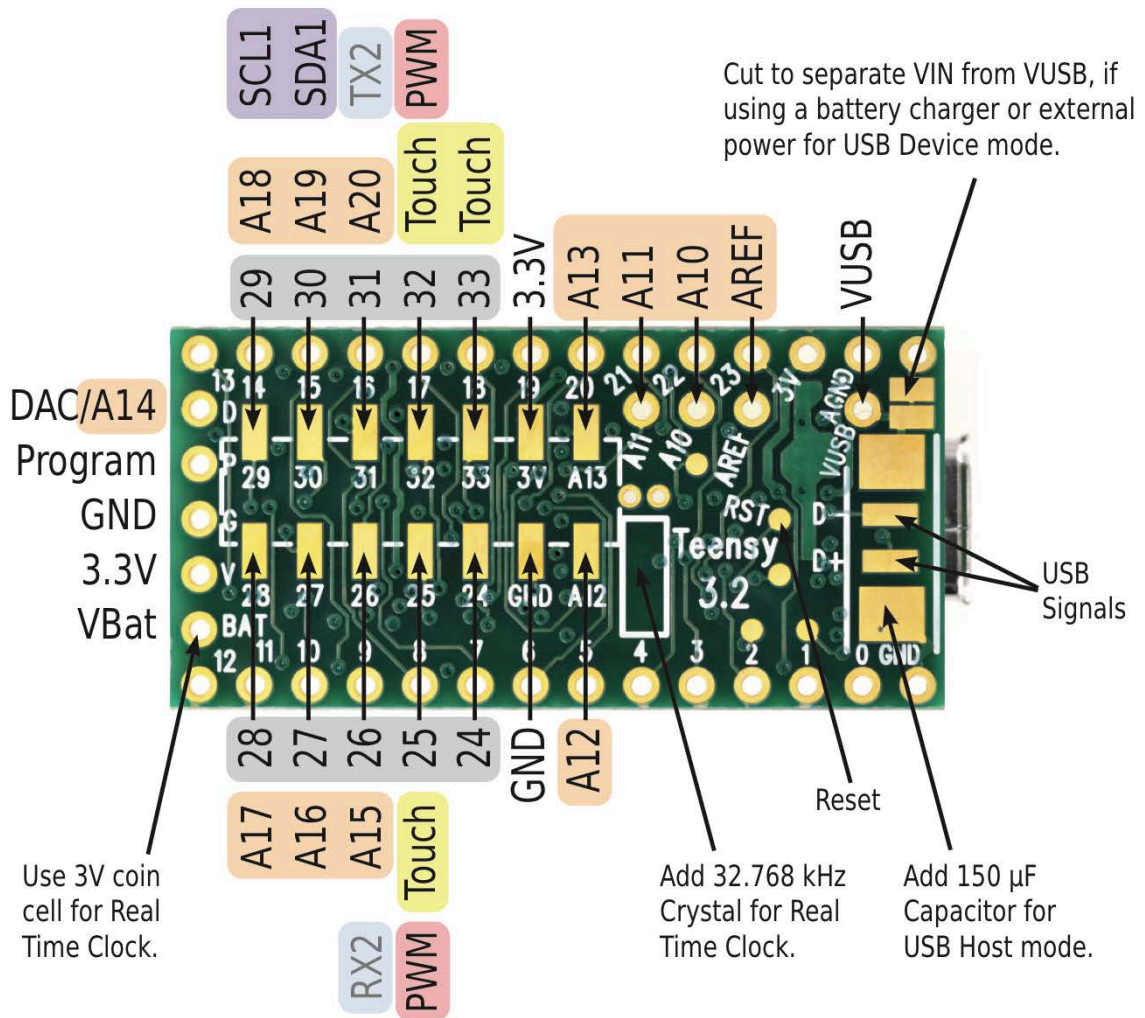

For solutions to the most common issues and technical support, please visit:

[www.pjrc.com/help](http://www.pjrc.com/help)