

Product Specification

100m Parallel MMF 100G QSFP28 Optical Transceiver FTLC9555REPM

PRODUCT FEATURES

- Hot-pluggable QSFP28 form factor
- Supports 103.1Gb/s aggregate bit rate
- Power dissipation < 2.5W
- RoHS-6 compliant
- Commercial case temperature range of 0°C to 70°C
- Single 3.3V power supply
- Maximum link length of 100m on OM4 Multimode Fiber (MMF)
- 4x25Gb/s 850nm VCSEL-based transmitter
- 4x25G electrical interface
- Single MPO12 receptacle
- I2C management interface

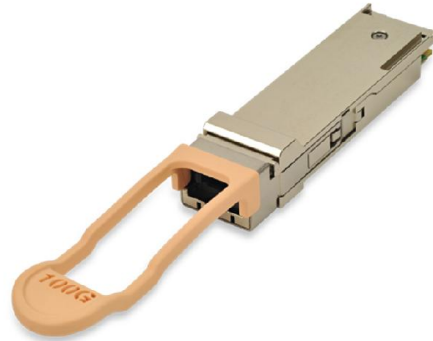

APPLICATIONS

- 100GBASE-SR4 100G Ethernet

Finisar's FTLC9555REPM 100G QSFP28 transceiver modules are designed for use in 100 Gigabit Ethernet links over multimode fiber. They are compliant with the QSFP28 MSA¹ and IEEE 802.3bm 100GBASE-SR4² and CAUI-4². Digital diagnostics functions are available via the I2C interface, as specified by the QSFP28 MSA¹ and Finisar Application Note AN-2141³. The transceiver is RoHS-6 compliant per Directive 2011/65/EU⁴ and Finisar Application Note AN-2038⁵.

PRODUCT SELECTION

FTLC9555REPM

- R: 100G Ethernet maximum bit rate (103.1Gb/s)
- E: 4x25G parallel optics
- P: Pull tab release
- M: MPO receptacle

I. Pin Descriptions

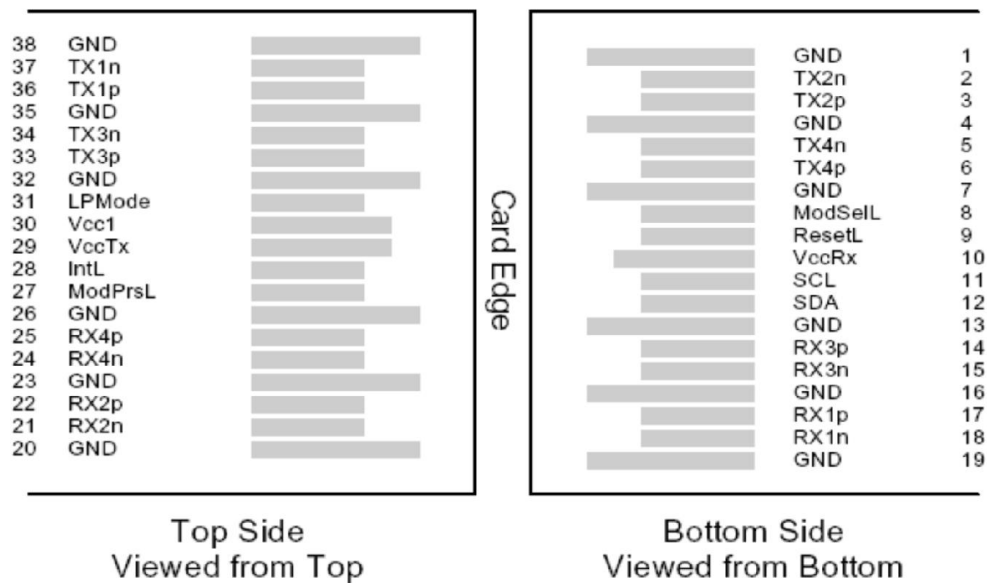

Figure 1 – QSFP28-compliant 38-pin connector (per SFF-8679)

Pin	Symbol	Name/Description	Notes
1	GND	Ground	1
2	Tx2n	Transmitter Inverted Data Input	
3	Tx2p	Transmitter Non-Inverted Data Input	
4	GND	Ground	1
5	Tx4n	Transmitter Inverted Data Input	
6	Tx4p	Transmitter Non-Inverted Data Input	
7	GND	Ground	1
8	ModSelL	Module Select	
9	ResetL	Module Reset	
10	Vcc Rx	+3.3 V Power supply receiver	
11	SCL	2-wire serial interface clock	
12	SDA	2-wire serial interface data	
13	GND	Ground	1
14	Rx3p	Receiver Non-Inverted Data Output	
15	Rx3n	Receiver Inverted Data Output	
16	GND	Ground	1
17	Rx1p	Receiver Non-Inverted Data Output	
18	Rx1n	Receiver Inverted Data Output	
19	GND	Ground	1
20	GND	Ground	1
21	Rx2n	Receiver Inverted Data Output	
22	Rx2p	Receiver Non-Inverted Data Output	
23	GND	Ground	1
24	Rx4n	Receiver Inverted Data Output	
25	Rx4p	Receiver Non-Inverted Data Output	
26	GND	Ground	1
27	ModPrsL	Module Present	
28	IntL	Interrupt	
29	Vcc Tx	+3.3 V Power supply transmitter	
30	Vcc1	+3.3 V Power Supply	

31	LPMODE	Low Power Mode	
32	GND	Ground	1
33	Tx3p	Transmitter Non-Inverted Data Input	
34	Tx3n	Transmitter Inverted Data Input	
35	GND	Ground	1
36	Tx1p	Transmitter Non-Inverted Data Input	
37	Tx1n	Transmitter Inverted Data Input	
38	GND	Ground	1

Notes

1. Circuit ground is internally isolated from chassis ground.

II. Absolute Maximum Ratings

Module performance is not guaranteed beyond the operating range (see Section VI). Exceeding the limits below may damage the transceiver module permanently.

Parameter	Symbol	Min	Typ	Max	Unit	Ref.
Maximum Supply Voltage	V _{CC}	-0.5		4.0	V	
Storage Temperature	T _S	-40		85	°C	
Case Operating Temperature	T _{OP}	0		70	°C	1
Relative Humidity	RH	15		85	%	2
Receiver Damage Threshold, per Lane	P _{Rdmg}	3.4			dBm	

Notes:

1. Can support temporary excursions of case operating temperature from -5 to -75 °C not exceeding 72 hours.
2. Non-condensing.

III. Electrical Characteristics (EOL, T_{OP} = 0 to 70 °C, V_{CC} = 3.135 to 3.465 Volts)

Parameter	Symbol	Min	Typ	Max	Unit	Ref.
Supply Voltage	V _{CC}	3.135		3.465	V	
Supply Current	I _{CC}			0.8	A	
Module total power	P			2.5	W	1
Transmitter						
Signaling rate per lane		25.78125 ± 100ppm			Gb/s	
Differential pk-pk input voltage tolerance	V _{in,pp,diff}			900	mV	
Single-ended voltage tolerance	V _{in,pp}	-0.35		+3.3	V	
Module stress input test		Per Section 83E.3.4.1, IEEE 802.3bm				
Receiver						
Signaling rate per lane		25.78125 ± 100ppm			Gb/s	
Differential data output swing	V _{out,pp}	100		400	mVpp	2
		300		600		
		400	600	800		
		600		1200		
Eye width		0.57			UI	
Eye height, differential		228			mV	
Vertical eye closure	VEC	5.5			dB	
Transition time (20% to 80%)	t _r , t _f	12			ps	

Notes:

- Maximum total power value is specified across the full operational temperature and voltage range when CDRs are locked or a lack of input signal results in squelch being activated. If incorrect frequencies cause the CDRs to continuously attempt to lock, maximum power dissipation may reach 3.5 W.
- Output voltage is settable in 4 discrete ranges via I2C. Default range is Range 2 (400 – 800 mV).

IV. Optical Characteristics (EOL, T_{OP} = 0 to 70°C, V_{CC} = 3.135 to 3.465 Volts)

Parameter	Symbol	Min	Typ	Max	Unit	Ref.
Transmitter						
Signaling Speed per Lane		25.78125 ± 100ppm			Gb/s	1
Center wavelength		840	850	860	nm	
RMS Spectral Width	SW			0.6	nm	
Average Launch Power per Lane	TXP _x	-8.4		2.4	dBm	
Transmit OMA per Lane	TxOMA	-6.4		3	dBm	
Launch Power [OMA] minus TDEC per Lane	P-TDEC	-7.3			dBm	
TDEC per Lane	TDEC			4.3	dBm	
Optical Extinction Ratio	ER	2			dB	
Optical Return Loss Tolerance	ORL			12	dB	
Encircled Flux	FLX	>86% at 19 um <30% at 4.5 um				
Average Launch Power of OFF Transmitter, per Lane				-30	dBm	
Transmitter Eye mask definition {X1, X2, X3, Y1, Y2, Y3}		{0.3,0.38,0.45,0.35,0.41,0.5}				2
Receiver						
Signaling Speed per Lane		25.78125 ± 100ppm			GBd	3
Center wavelength		840		860	nm	
Damage Threshold	DT	3.4			dBm	
Average Receive Power per Lane	RXP _x	-10.3		2.4	dBm	4
Receive Power (OMA) per Lane	RxOMA			3	dBm	
Receiver Reflectance	Rfl			-12	dB	
Stressed Receiver Sensitivity (OMA) per Lane	SRS			-5.2	dBm	
Stressed Conditions:						
Stressed Eye Closure	SEC	4.3			dB	
Stressed Eye J2 Jitter	J2	0.39			UI	
Stressed Eye J4 Jitter	J4	0.53			UI	
OMA of each aggressor lane		3			dBm	
Stressed Receiver Eye Mask Definition {X1, X2, X3, Y1, Y2, Y3}		{0.28,0.5,0.5,0.33,0.33,0.4}				5
LOS De-Assert	LOS _D			-13	dBm	
LOS Assert	LOS _A	-30			dBm	
LOS Hysteresis		0.5	2		dB	

Notes:

- Transmitter consists of 4 lasers operating at a maximum speed of 25.78125Gb/s ±100ppm each.
- Hit Ratio 1.5 x 10⁻³ hits/sample.
- Receiver consists of 4 photodetectors operating at a maximum speed of 25.78125Gb/s ±100ppm each.
- Minimum value is informative only and not the principal indicator of signal strength.
- Hit Ratio 5 x 10⁻⁵ hits/sample.

V. General Specifications

Parameter	Symbol	Min	Typ	Max	Units	Ref.
Bit Rate (all wavelengths combined)	BR			103.1	Gb/s	1
Bit Error Ratio (pre-FEC)	BER			5×10^{-5}		2
Maximum Supported Distances						
Fiber Type						
OM3 MMF	Lmax1			70	m	3
OM4 MMF	Lmax2			100	m	3

Notes:

1. Supports 100GBASE-SR4 per IEEE 802.3bm.
2. Tested with a $2^{31} - 1$ PRBS.
3. Requires FEC on the host to support maximum distance, per 100GBASE-SR4.

VI. Environmental Specifications

Finisar FTLC9555 QSFP28 transceivers have a commercial operating case temperature range of 0°C to +70°C. They can support temporary excursions to case temperatures of -5°C and +75°C without permanent damage (see Section II).

Parameter	Symbol	Min	Typ	Max	Units	Ref.
Case Operating Temperature	T _{op}	0		70	°C	
Storage Temperature	T _{sto}	-40		85	°C	

VII. Regulatory Compliance

Finisar FTLC9555 QSFP28 transceivers are Class 1 Laser Products. They are certified per the following standards:

Feature	Agency	Standard
Laser Eye Safety	FDA/CDRH	CDRH 21 CFR 1040 and Laser Notice 50
Laser Eye Safety	TÜV	EN 60825-1:2014 EN 60825-2:2004+A1+A2
Electrical Safety	TÜV	EN 60950-1:2006+A11+A1+A12+A2
Electrical Safety	UL/CSA	CAN/CSA-C22.2 No. 60950-1-07+A2:2014 ANSI/UL Std. No. 60950-1:2014

Copies of the referenced certificates will be available at Finisar upon request. Complies with FDA performance standards for laser products except for deviations pursuant to Laser Notice No. 50, dated June 24, 2007.

CAUTION – Use of Controls or adjustments or performance of procedures other than those specified herein may result in hazardous radiation exposure.

VIII. Digital Diagnostics Functions

FTLC9555 QSFP28 transceivers support the I2C-based diagnostics interface specified by the QSFP28 MSA¹. See Finisar Application Note AN-2141³.

IX. Memory Contents

Per the QSFP28 MSA¹. See Finisar Application Note AN-2141³.

XI. Mechanical Specifications

Finisar FTLC9555 QSFP28 transceivers are compatible with the QSFP28 MSA specification¹.

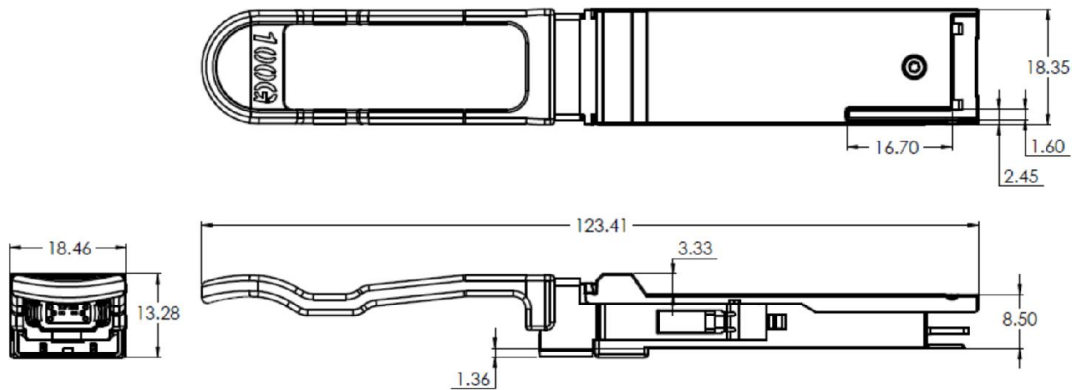

Figure 2. FTLC9555REPM Mechanical Dimensions.



Figure 3. Standard Product Label

XII. References

1. SFF-8665: “QSFP+ 28Gb/s 4X Pluggable Transceiver Solution (QSFP28)”, Rev 1.9, June 29, 2015 (and associated SFF documents)
 - i. SFF-8661
 - ii. SFF-8679
 - iii. SFF-8636
 - iv. SFF-8662
 - v. SFF-8663
 - vi. SFF-8672
 - vii. SFF-8683
2. IEEE 802.3bm, PMD Type 100GBASE-SR4 and CAUI-4.
3. Application Note AN-2141, “100G QSFP28 SR4 NVR Application Note”, Finisar Corporation.
4. Directive 2011/65/EU of the European Parliament and of the Council, “on the restriction of the use of certain hazardous substances in electrical and electronic equipment,” July 1, 2011.
5. “Application Note AN-2038: Finisar Implementation Of RoHS Compliant Transceivers”, Finisar Corporation, January 21, 2005.

For More Information:

Finisar Corporation
1389 Moffett Park Drive
Sunnyvale, CA 94089-1133
Tel. 1-408-548-1000
Fax 1-408-541-6138
sales@finisar.com
www.finisar.com