

## ADJUSTABLE HIGH PRECISION SHUNT REGULATOR

### ■GENERAL DESCRIPTION

The **NJM2820/ 2821/ 2822** is a 1.25V precision shunt regulator.

High precision voltage accuracy of  $\pm 0.7\%$ \* is realized by the total optimization from chip design to packaging. In addition, it features low cathode current of 80uA for low current operation.

It is suitable for AC-DC converter secondary circuit, reference voltage applications for A/D and D/A converters, and other applications where precision reference is required.

### ■PACKAGE OUTLINE

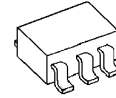

**NJM2820F**  
**NJM2821F**  
**NJM2822F**

### ■FEATURES

- High Precision Voltage Reference                      1.250V $\pm$ 0.7%
- Flow Soldering\*
- Minimum Input Current                                      80uA typ.
- Operating Voltage    V<sub>REF</sub> to 13V
- Adjustable Output Voltage
- Bipolar Technology
- Package Outline                      MTP5

### ■BLOCK DIAGRAM

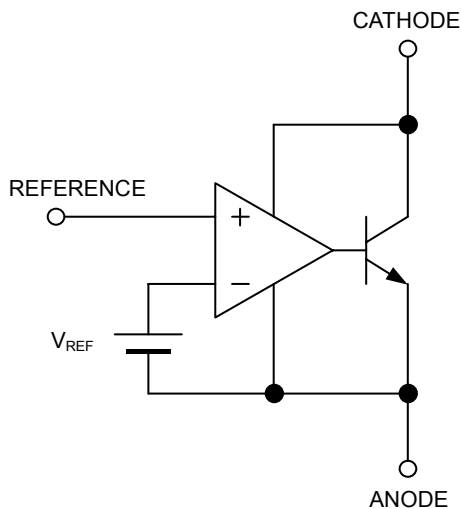

### ■PIN CONFIGURATION

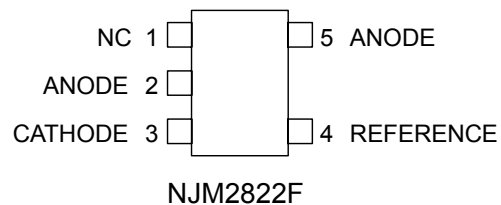
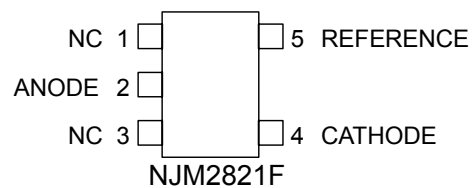
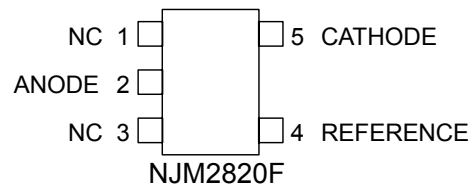

\* These contents are based on the result that evaluated the arbitrary sample. The characteristic is not guaranteed. The design and reliability that fully considered flow mounting are checked but the influence by temperature profile etc. is also considered. Please consult with sales representatives for a recommendation temperature profile.

# NJM2820, NJM2821, NJM2822

## ■ABSOLUTE MAXIMUM RATINGS (Ta=25°C)

PARAMETER	SYMBOL	MAXIMUM RATINGS	UNIT
Cathode Voltage	$V_{KA}$	14	V
Continuous Cathode Current	$I_K$	-30 ~ 50	mA
Reference Input Current	$I_{REF}$	-10 ~ 0.05	mA
Power Dissipation	$P_D$	(MTP5) 200	mW
Operating Temperature Range	$T_{OPR}$	-40 ~ +85	°C
Storage Temperature Range	$T_{STG}$	-40 ~ +150	°C

## ■RECOMMENDED OPERATING CONDITIONS (Ta=25°C)

PARAMETER	SYMBOL	MIN.	TYP.	MAX.	UNIT
Cathode Voltage	$V_{KA}$	$V_{REF}$	-	13	V
Cathode Current	$I_K$	0.5	-	30	mA

## ■ELECTRICAL CHARACTERISTICS ( $I_K=1mA, Ta=25°C$ )

PARAMETER	SYMBOL	TEST CONDITION	MIN.	TYP.	MAX.	UNIT
Reference Voltage	$V_{REF}$	$V_{KA}=V_{REF}$ (*1)	1241	1250	1259	mV
Reference Voltage Change vs. Cathode Voltage Change	$\frac{\Delta V_{REF}}{\Delta V_{KA}}$	$ V_{REF}  \leq V_{KA} \leq 5V$ (*2)	-	-	$\pm 2.7$	mV/V
		$5V \leq V_{KA} \leq 13V$ (*2)	-	-	$\pm 2.0$	mV/V
Reference Input Current	$I_{REF}$	$R1=10k\Omega, R2=\infty$ (*2)	-	2.0	4.0	$\mu A$
Minimum Input Current	$I_{MIN}$	$V_{KA}=V_{REF}, \Delta V_{REF}=1\%$ (*1)	-	80	500	$\mu A$
Cathode Current (Off Cond.)	$I_{OFF}$	$V_{KA}=13V, V_{REF}=0V$ (*3)	-	0.01	1.0	$\mu A$
Dynamic Impedance	$ Z_{KA} $	$V_{KA}=V_{REF}, f \leq 1kHz$ $0.5mA \leq I_K \leq 30mA$ (*1)	-	0.12	-	$\Omega$

## ■TEMPERATURE CHARACTERISTICS ( $I_K=1mA, Ta=-40°C \sim 85°C$ )

PARAMETER	SYMBOL	TEST CONDITION	MIN.	TYP.	MAX.	UNIT
Reference Voltage Change	$\Delta V_{REF}$	$V_{KA}=V_{REF}$ (*1)	-	$\pm 10$	-	mV
Reference Input Current Change	$\Delta I_{REF}$	$R1=10k\Omega, R2=\infty$ (*2)	-	0.5	-	$\mu A$

$|V_{REF}|$ ...Reference voltage includes error.

(\*1): Test Circuit (Fig.1)

(\*2): Test Circuit (Fig.2)

(\*3): Test Circuit (Fig.3)

In case of NJM2822, all electrical characteristics are measured referencing to the anode terminal of PIN 5.

## ■TEST CIRCUIT

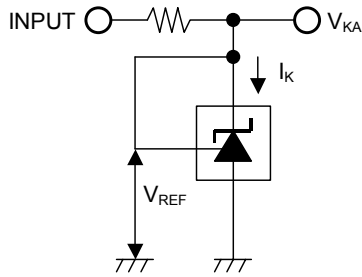

Fig.1  $V_{KA}=V_{REF}$  to test circuit

$$V_O = V_{KA} = V_{REF}$$

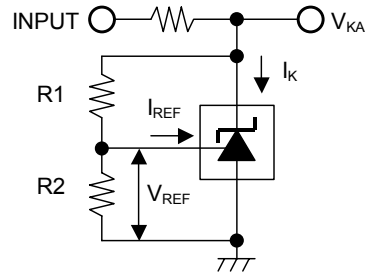

Fig.2  $V_{KA} > V_{REF}$  to test circuit

$$V_O = V_{KA} = V_{REF} \left( 1 + \frac{R1}{R2} \right) + I_{REF} \times R1$$

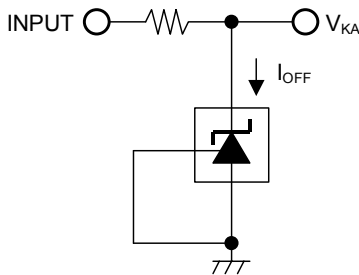

Fig.3  $I_{OFF}$  to test circuit

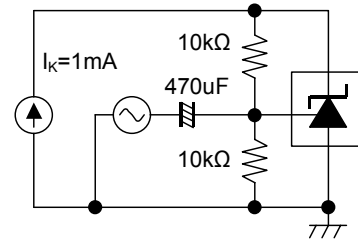
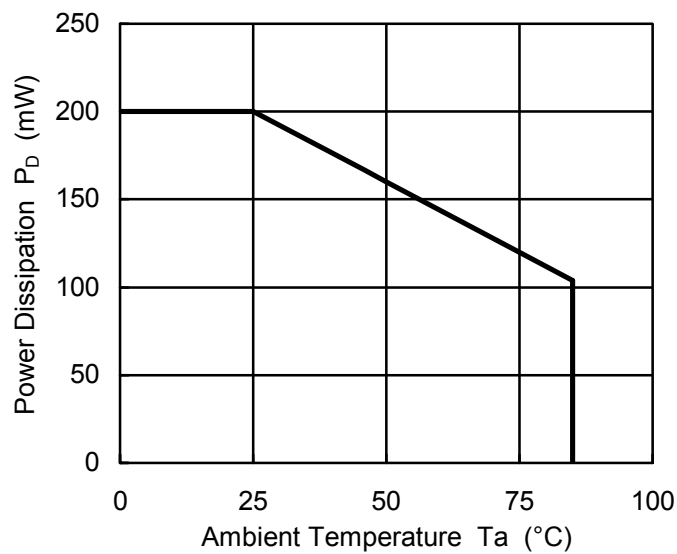

Fig.4 Gain and Phase to test circuit

## ■POWER DISSIPATION VS. AMBIENT TEMPERATURE



# NJM2820, NJM2821, NJM2822

## ■ TYPICAL CHARACTERISTICS

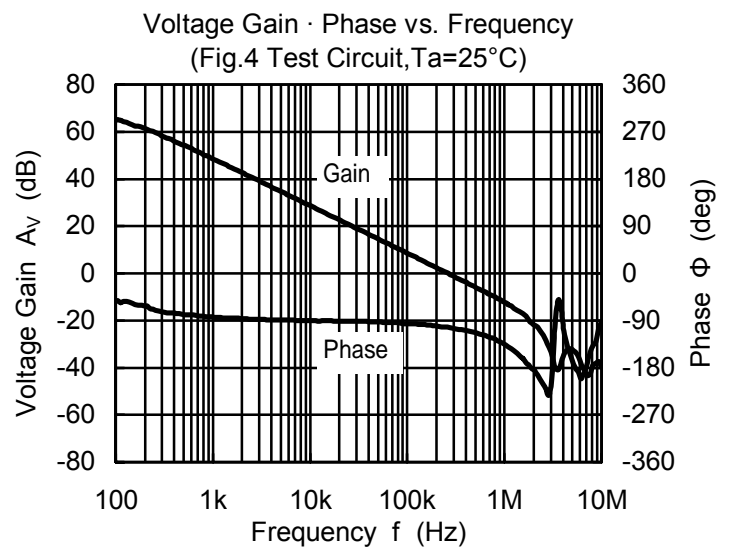
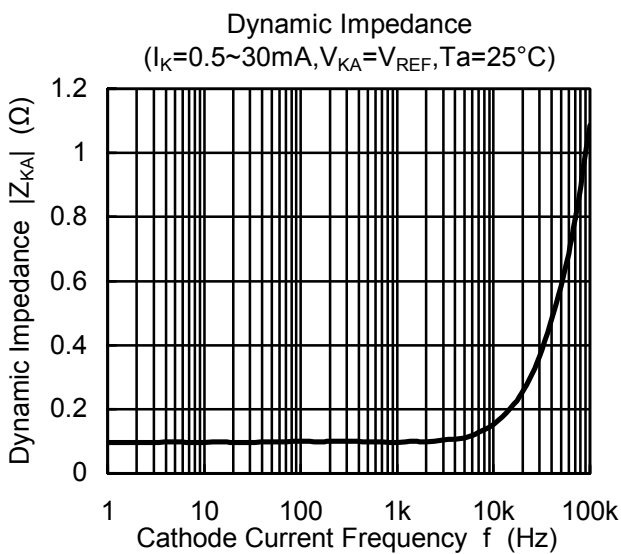
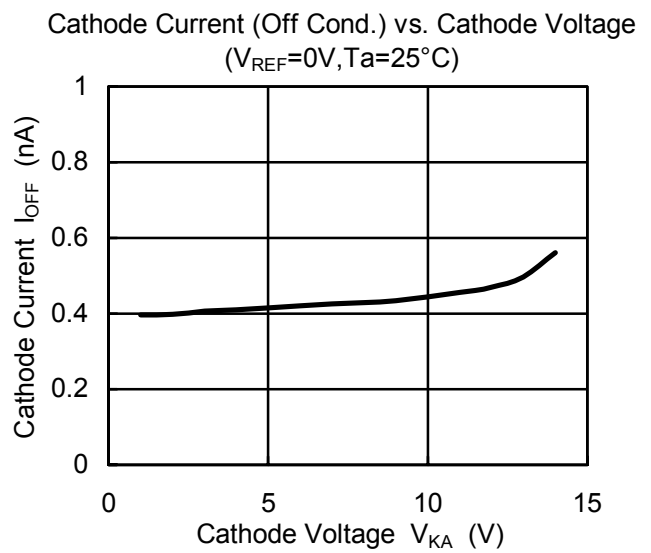
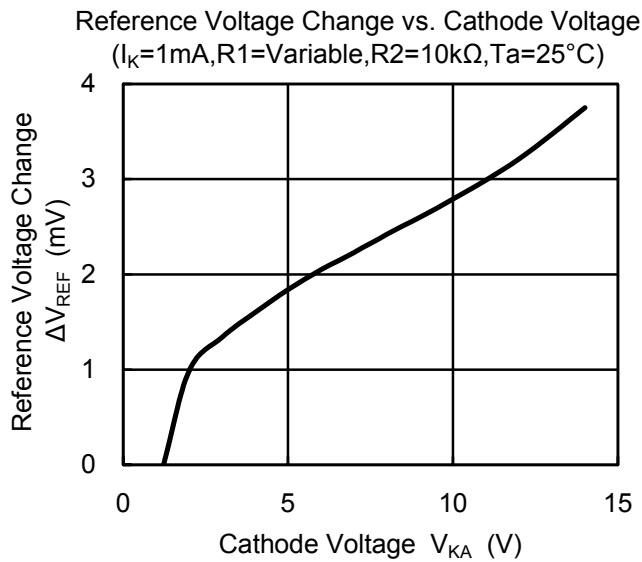
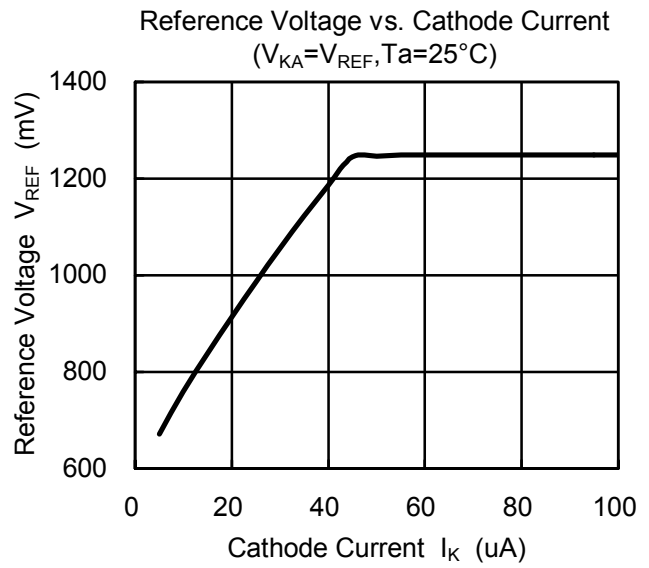
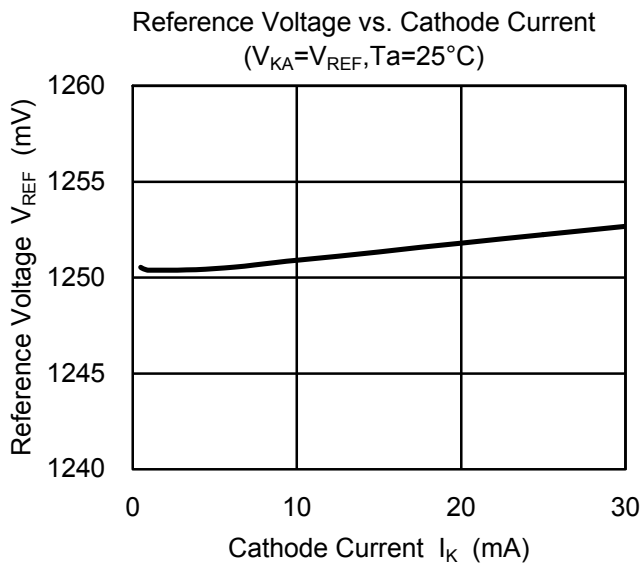

## ■ TYPICAL CHARACTERISTICS

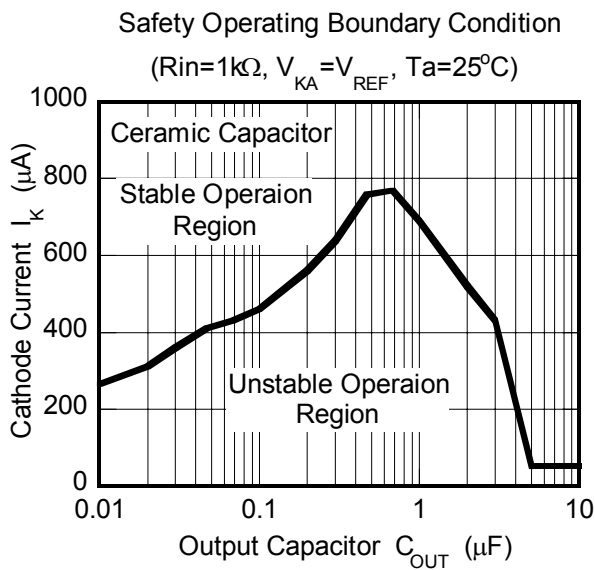

## Safety Operating Boundary Condition Test Circuit

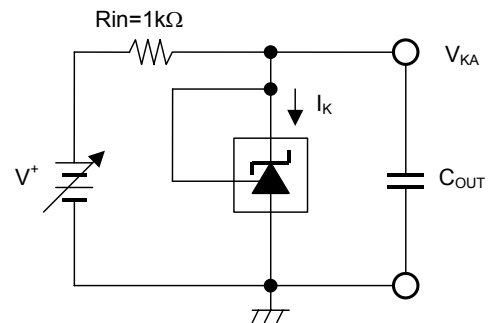

Note) Oscillation might occur while operating within the range of safety curve.

So that, it is necessary to make ample margins by taking considerations of fluctuation of the device.

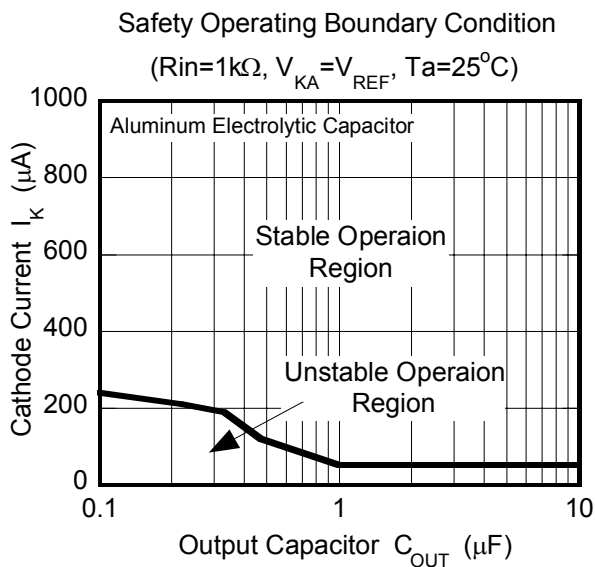

# NJM2820, NJM2821, NJM2822

## ■ TYPICAL CHARACTERISTICS

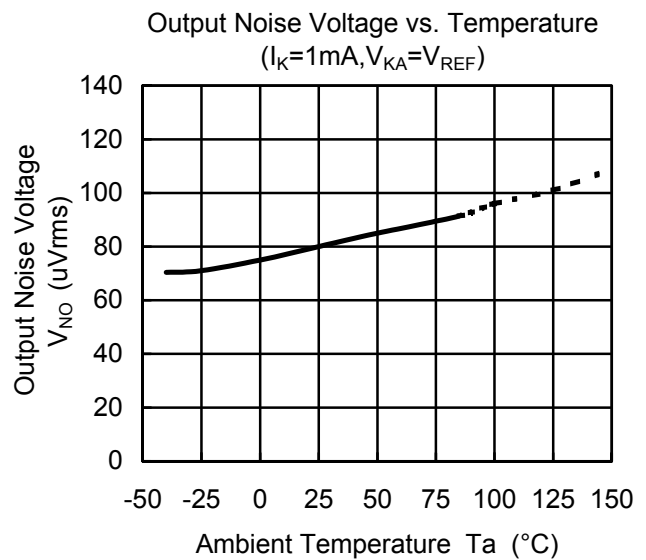
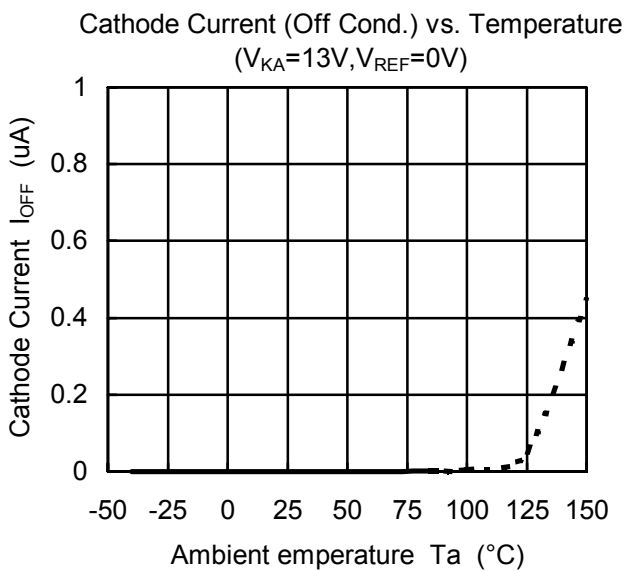
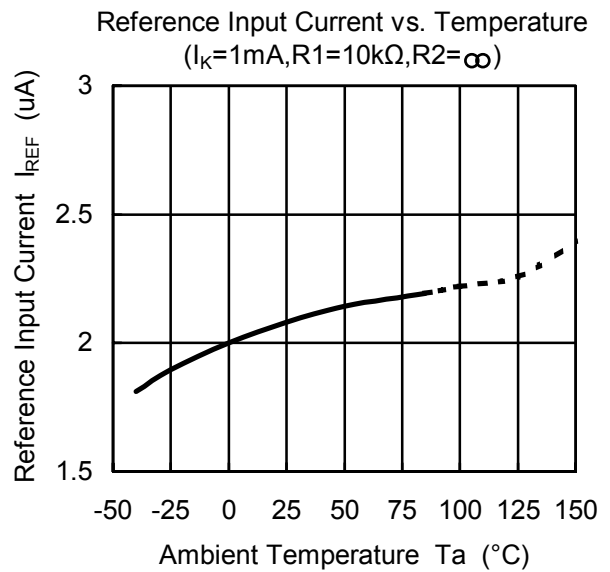
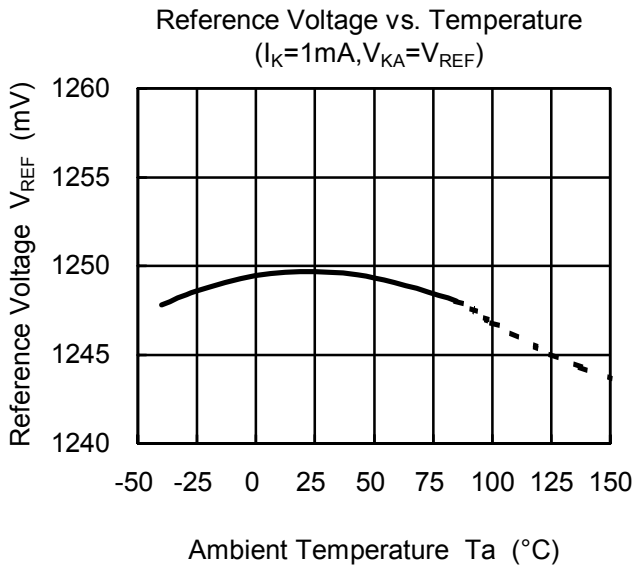

## MEMO

**[CAUTION]**

The specifications on this databook are only given for information, without any guarantee as regards either mistakes or omissions. The application circuits in this databook are described only to show representative usages of the product and not intended for the guarantee or permission of any right including the industrial rights.

# Mouser Electronics

Authorized Distributor

Click to View Pricing, Inventory, Delivery & Lifecycle Information:

[NJR:](#)

[NJM2822F-TE1](#) [NJM2821F-TE1](#) [NJM2820F-TE1](#)