

Selection Guide

Part No.	Dice	Lens Type	Iv (ucd) [1] @ 10mA		Description
			Min.	Typ.	
ACSC56-41QBWA/D-F01	Blue (InGaN)	White Diffused	5600	15000	Common Cathode, Rt. Hand Decimal.

Notes:

1. Luminous intensity/ luminous Flux: +/-15%.
2. Luminous intensity value is traceable to the CIE127-2007 compliant national standards.

Electrical / Optical Characteristics at TA=25°C

Symbol	Parameter	Device	Typ.	Max.	Units	Test Conditions
λ_{peak}	Peak Wavelength	Blue	460		nm	IF=20mA
λ_D [1]	Dominant Wavelength	Blue	465		nm	IF=20mA
$\Delta\lambda_{1/2}$	Spectral Line Half-width	Blue	25		nm	IF=20mA
C	Capacitance	Blue	100		pF	VF=0V;f=1MHz
VF [2]	Forward Voltage	Blue	3.3	4.0	V	IF=20mA
IR	Reverse Current	Blue		50	uA	VR=5V

Notes:

- 1.Wavelength: +/-1nm.
- 2.Forward Voltage: +/-0.1V.
- 3.Wavelength value is traceable to the CIE127-2007 compliant national standards.

Absolute Maximum Ratings at TA=25°C

Parameter	Blue	Units
Power dissipation	120	mW
DC Forward Current	30	mA
Peak Forward Current [1]	150	mA
Reverse Voltage	5	V
Operating / Storage Temperature	-40°C To +85°C	

Note:

1. 1/10 Duty Cycle, 0.1ms Pulse Width.

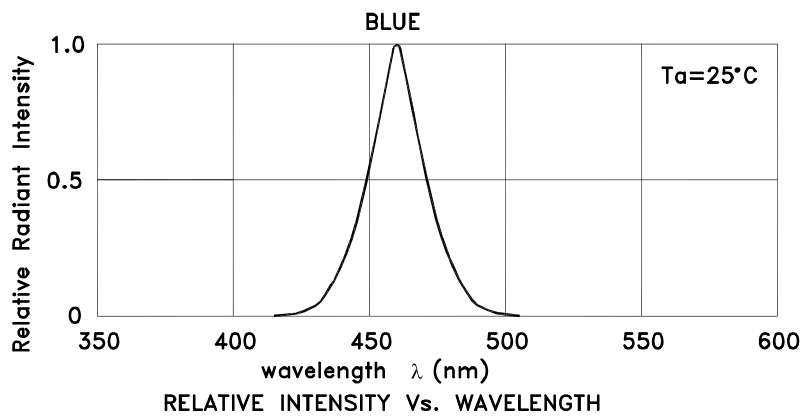

Blue

ACSC56-41QBWA/D-F01

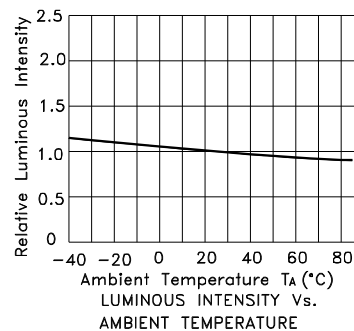
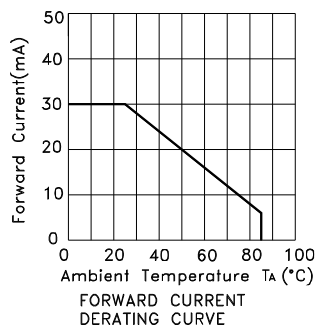
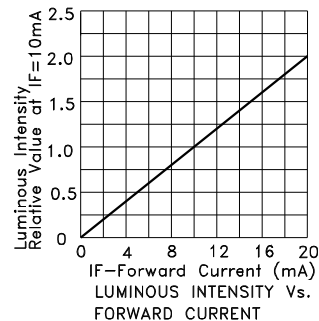
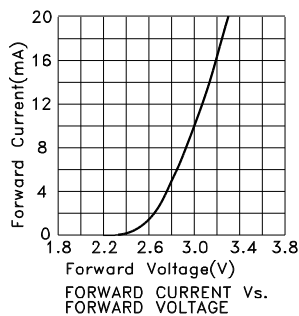

CIRCUIT DESIGN NOTES

1. Protective current-limiting resistors may be necessary to operate the Displays.
2. LEDs mounted in parallel should each be placed in series with its own current-limiting resistor.

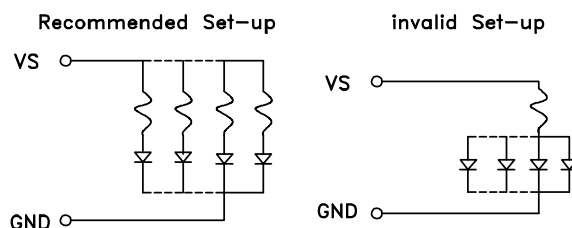

ACSC56-41QBWA/D-F01

Reflow Soldering Profile For Lead-free SMT Process.

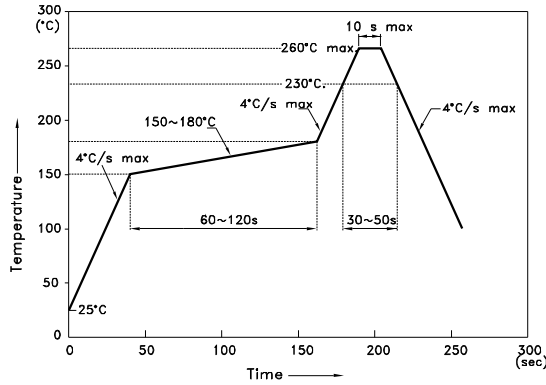

NOTES:

1. We recommend the reflow temperature 245°C(+/-5°C). The maximum soldering temperature should be limited to 260°C.
2. Don't cause stress to the epoxy resin while it is exposed to high temperature.
3. Number of reflow process shall be 2 times or less.

Recommended Soldering Pattern (Units : mm; Tolerance: ± 0.15)

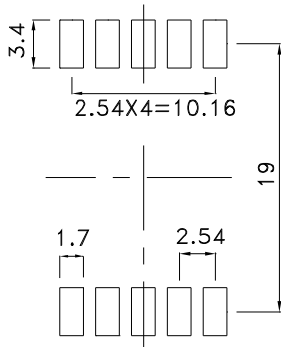

Reel Dimension

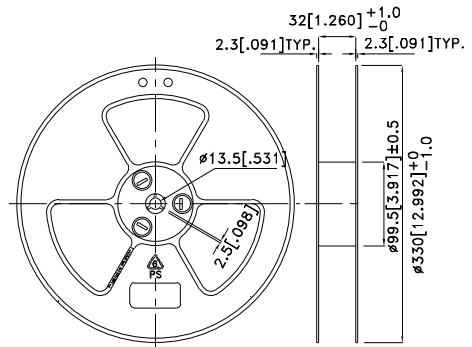

Tape Specifications (Units : mm)

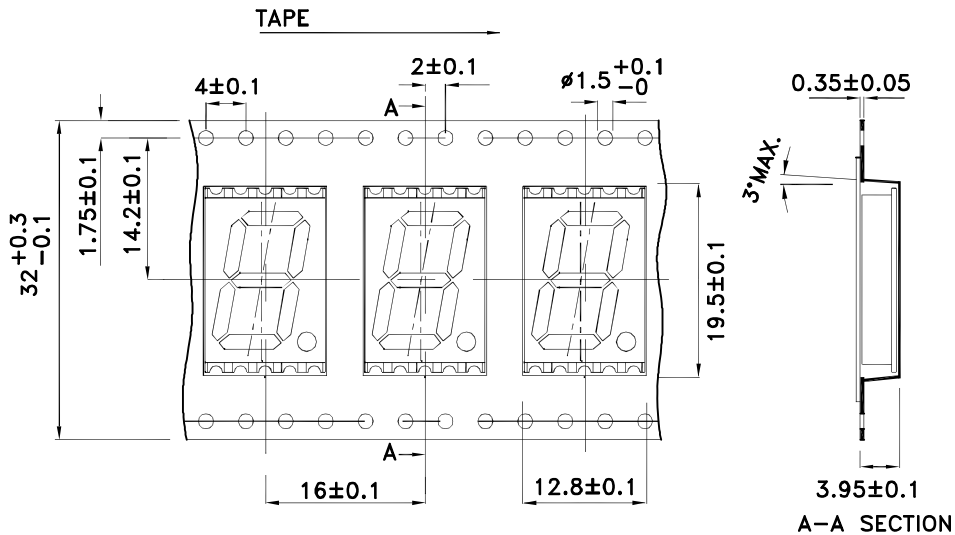

PACKING & LABEL SPECIFICATIONS

ACSC56-41QBWA/D-F01

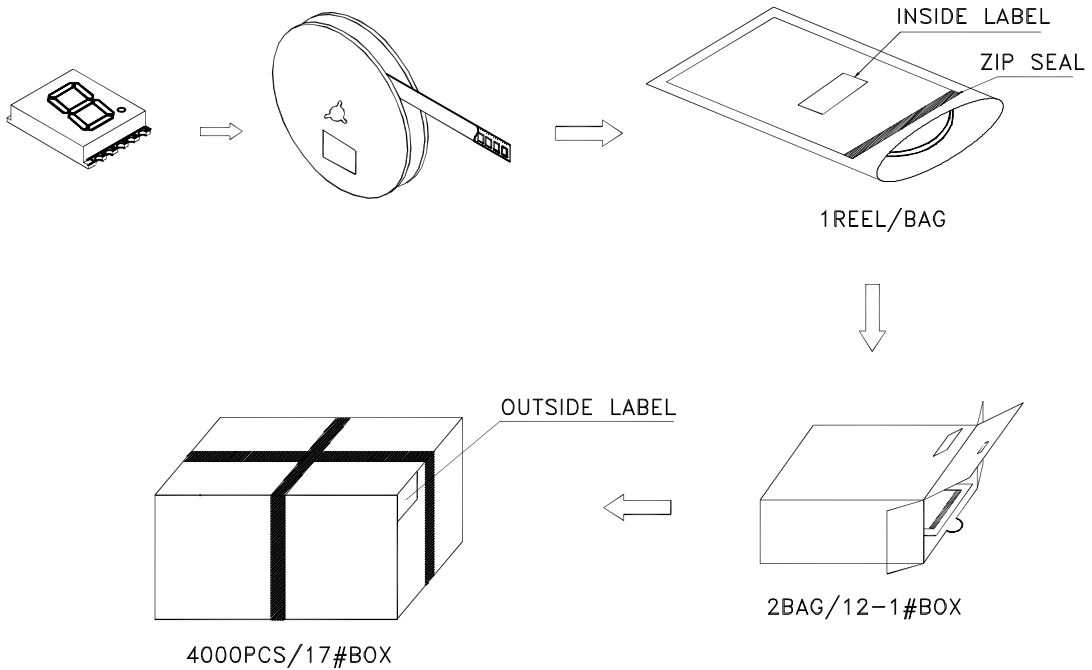

Inside Label on Tape

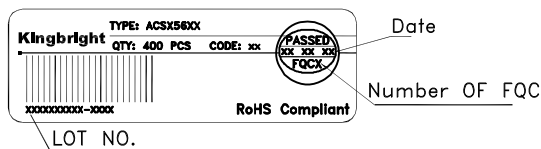

Outside Label on Bag

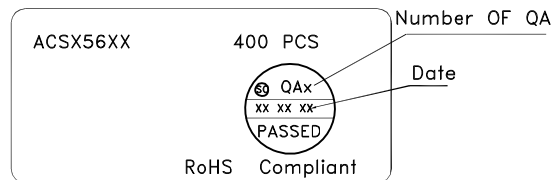

Outside Label on 17#Box

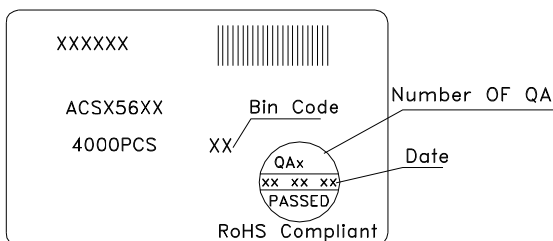

Outside Label on 12-1#Box

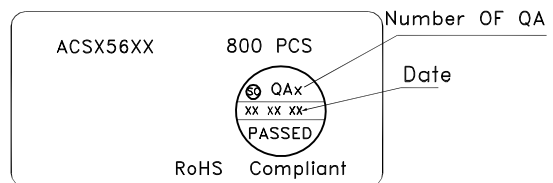

All design applications should refer to Kingbright application notes available at <http://www.KingbrightUSA.com/ApplicationNotes>