

<b>PART NUMBER</b>	SML-LXFP0603UWW-TR	<b>REV</b>	B
<b>REV</b>	E.C.N. NUMBER AND REVISION COMMENTS	<b>DATE</b>	
A	ECN-Lumex201700047	08.14.17	
B	ECN-Lumex202000002	01.08.20	

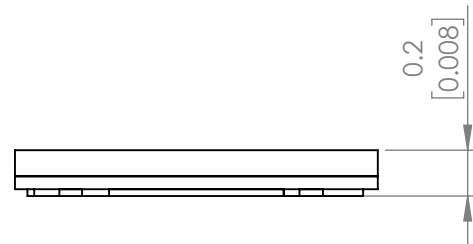

**POLARITY**

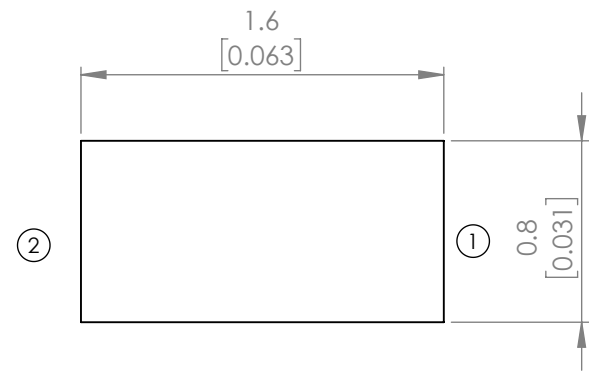
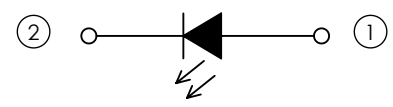

**ELECTRO-OPTICAL CHARACTERISTIC TA=25°C**

PARAMETER	MIN	TYP	MAX	UNITS	TEST COND
CHROMATICITY COORDINATES SPECIFICATIONS	X	-	0.29	-	If=5mA
	Y	-	0.28	-	
FORWARD VOLTAGE	-	2.8	3.0	Vf	If=5mA
REVERSE VOLTAGE	-	-	5	Vr	Ir=50uA
LUMINOUS INTENSITY	-	212	-	mcd	If=5mA
VIEWING ANGLE	-	130	-	2x theta1/2	If=5mA
EMITTED COLOR	WHITE				
EPOXY LENS FINISH	YELLOW DIFFUSED				

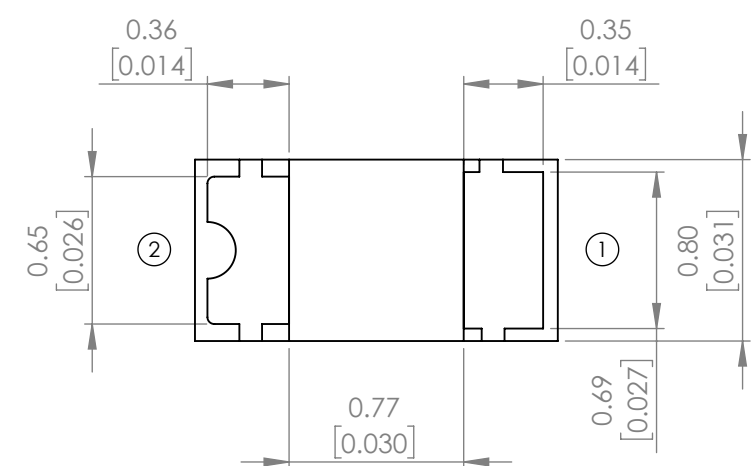

**RECOMMENDED SOLDER PAD LAYOUT**

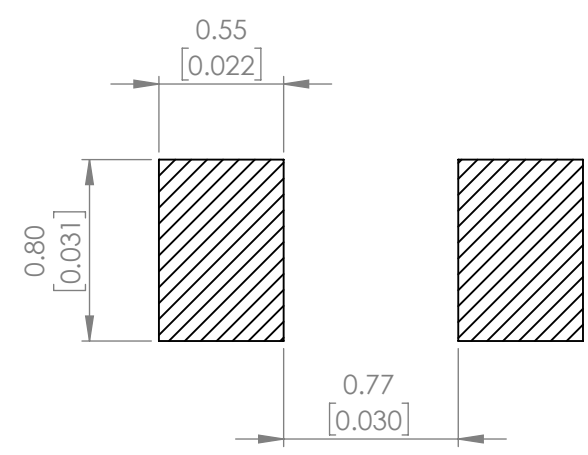

**ABSOLUTE MAXIMUM RATINGS TA=25°C**

PARAMETER	MAX	UNITS
PEAK FORWARD CURRENT*	100	mA
FORWARD CURRENT	25	mA
POWER DISIPATION	95	mW
ELECTROSTATIC DISCHARGE	150	V
STORAGE TEMPERATURE	-40 TO +90	°C
OPERATING TEMPERATURE	-40 TO +85	°C
SOLDERING TEMPERATURE	3 SEC. MAX @ 260	°C

\*t<10us

**MOISTURE SENSITIVE DEVICE  
PER JEDEC LEVEL 2 STANDARDS**

\*UNLESS OTHERWISE SPECIFIED TOLERANCES PER DECIMAL PRECISION ARE: X=±1 (±0.039), X.X=±0.5 (±0.020), X.XX=±0.25 (±0.010), X.XXX=±0.127 (±0.005). LEAD SIZE=±0.05 (±0.002), LEAD LENGTH=±0.75 (±0.030). MIN= <sup>+DECIMAL PRECISION</sup>/<sub>-0.00</sub> MAX= <sup>+0.00</sup>/<sub>-DECIMAL PRECISION</sub>

**PROFILE**

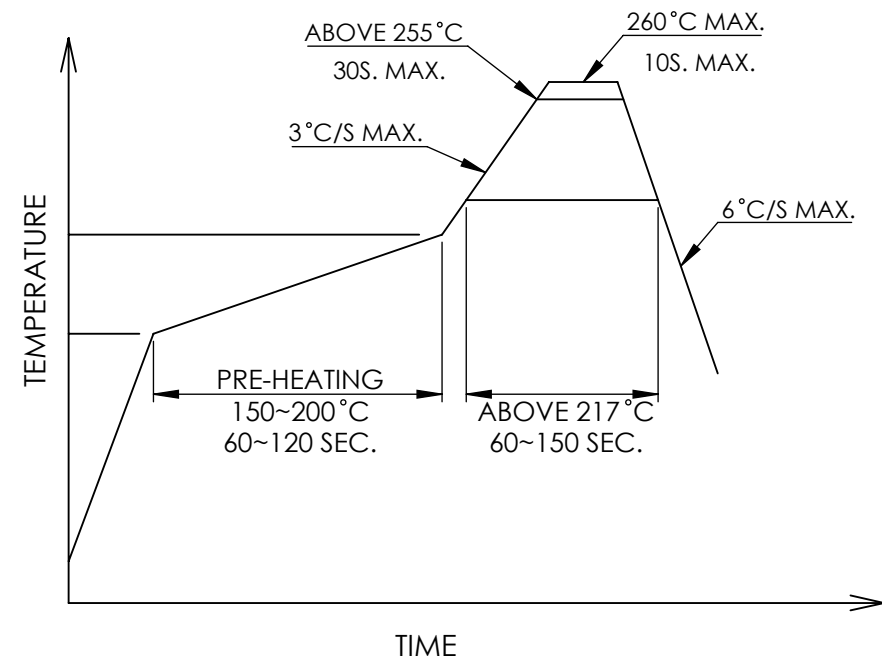

**CARRIER TAPE DIMENSION**

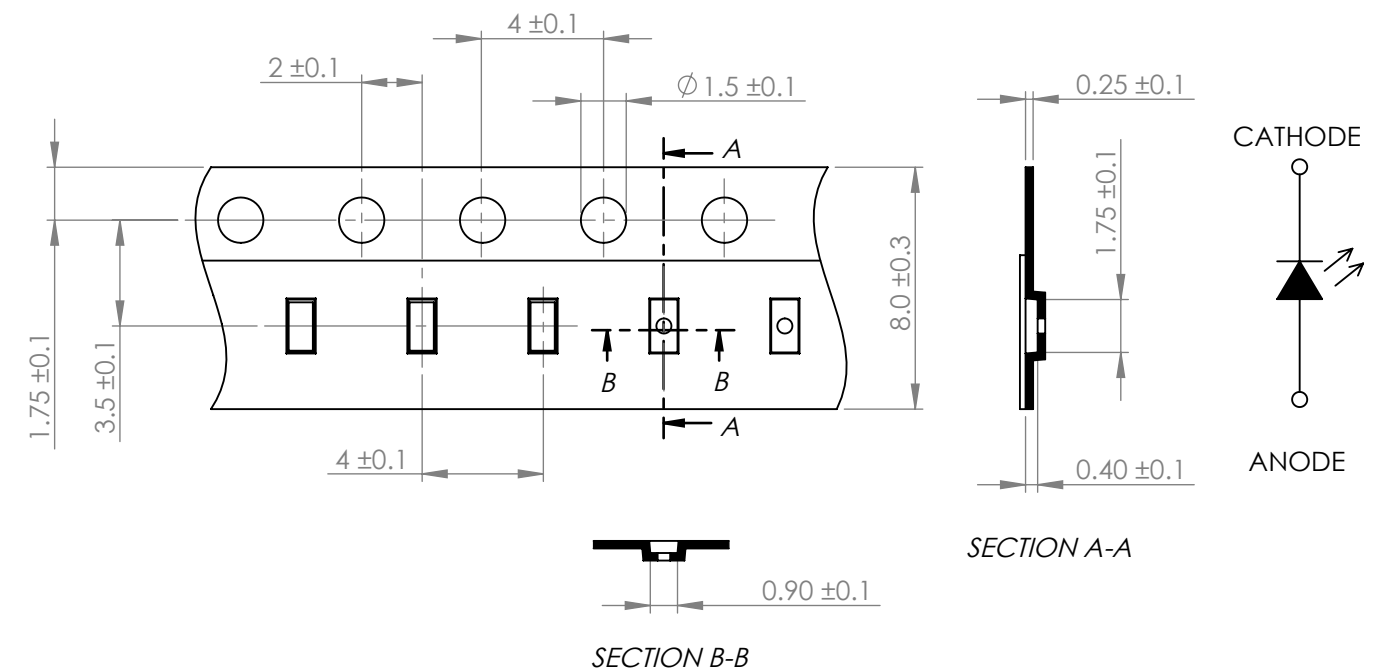

\*UNLESS OTHERWISE SPECIFIED TOLERANCES PER DECIMAL PRECISION ARE: X=±1 (±0.039), X.X=±0.5 (±0.020), X.XX=±0.25 (±0.010), X.XXX=±0.127 (±0.005). LEAD SIZE=±0.05 (±0.002), LEAD LENGTH=±0.75 (±0.030). MIN= <sup>+DECIMAL PRECISION</sup>/<sub>-0.00</sub> MAX.= <sup>+0.00</sup>/<sub>-DECIMAL PRECISION</sub>

 <p>425 N. GARY AVE. CAROL STREAM, IL 60188 PHONE : 800-278-5666 FAX : 630-315-2150 WEB : WWW.LUMEX.COM</p>	1.6(L)*0.8(W)*0.2(H)mm ULTRA THIN SMT LED, WHITE, DIFFUSED LENS, TAPE & REEL.	DATE : 2020.01.08	DRAWN BY : C.C.	
	**THE SPECIFICATIONS MAY CHANGE AT ANY TIME WITHOUT NOTICE.**	PAGE : 2 OF 2	CHKD BY : E.C.	
	CONFIDENTIAL INFORMATION	SCALE : NTF	APRVD BY : G.C.	
	THE INFORMATION CONTAINED IN THIS DOCUMENT IS THE PROPERTY OF LUMEX INC. EXCEPT AS SPECIFICALLY AUTHORIZED IN WRITING BY LUMEX INC., THE HOLDER OF THIS DOCUMENT SHALL KEEP ALL INFORMATION CONTAINED HEREIN CONFIDENTIAL AND SHALL PROTECT SAME IN WHOLE OR IN PART FROM DISCLOSURE AND DISSEMINATION TO ALL THIRD PARTIES.	UNIT : mm [INCH]	(Pb)	