

**Description**

Excellent unidirectional switches for phase control applications such as heating and motor speed controls. Standard phase control SCRs are triggered with few milliamperes of current at less than 1.5V potential.

**Features & Benefits**

- RoHS compliant
- Voltage capability up to 1600 V
- Surge capability up to 520 A
- Electrically isolated package "KD-Package" and UL recognized for 2500V<sub>RMS</sub>

**Agency Approval**

Agency	Agency File Number
	E71639

**Applications**

Typical applications are AC solid-state switches, industrial power tools, line rectification 50/60Hz.

**Main Features**

Symbol	Value	Unit
$I_{T(RMS)}$	55	A
$V_{DRM}/V_{RRM}$	1600	V
$I_{GT}$	70	mA

**Schematic Symbol**

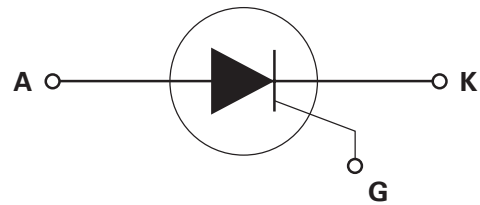

**Absolute Maximum Ratings**

Symbol	Parameter	Test Conditions	Value	Unit
$V_{DRM}/V_{RRM}$	Repetitive Peak off-state/Reverse Voltage		1600	V
$V_{DSM}/V_{RSM}$	Non-repetitive peak off-state/Reverse voltage		1700	V
$I_{T(RMS)}$	RMS on-state current	$T_c = 55^\circ\text{C}$	55	A
$I_{T(AV)}$	Average on-state current	$T_c = 55^\circ\text{C}$	35	A
$I_{TSM}$	Peak non-repetitive surge current	single half cycle; $f = 50\text{Hz}$ ; $T_j(\text{initial}) = 25^\circ\text{C}$	550	A
		single half cycle; $f = 60\text{Hz}$ ; $T_j(\text{initial}) = 25^\circ\text{C}$	660	
$I^2t$	$I^2t$ Value for fusing	$t_p = 8.3 \text{ ms}$	1800	$\text{A}^2\text{s}$
$di/dt$	Critical rate of rise of on-state current		150	$\text{A}/\mu\text{s}$
$I_{GM}$	Peak gate current	$T_j = 125^\circ\text{C}$	3	A
$P_{G(AV)}$	Average gate power dissipation	$T_j = 125^\circ\text{C}$	1	W
$T_{stg}$	Storage temperature range		-40 to 150	$^\circ\text{C}$
$T_j$	Operating junction temperature range		-40 to 125	$^\circ\text{C}$

**Electrical Characteristics ( $T_J = 25^\circ\text{C}$ , unless otherwise specified)**

Symbol	Test Conditions		Value	Unit
$I_{GT}$	$V_D = 12\text{V}; R_L = 30\ \Omega$	MAX.	70	mA
$V_{GT}$		MAX.	1.5	V
dv/dt	$V_D = 2/3 V_{DRM}$ ; gate open; $T_J = 125^\circ\text{C}$	MIN.	2000	V/ $\mu\text{s}$
$V_{GD}$	$V_D = V_{DRM}$ ; $R_L = 3.3\ \text{k}\Omega$ ; $T_J = 125^\circ\text{C}$	MIN.	0.2	V
$I_H$	$I_T = 500\text{mA}$ (initial)	MAX.	200	mA
$t_q$	$I_T = 0.5\text{A}$ ; $t_p = 50\mu\text{s}$ ; $dv/dt = 5\text{V}/\mu\text{s}$ ; $di/dt = 30\text{A}/\mu\text{s}$	TYP.	20	$\mu\text{s}$
$t_{gt}$	$I_G = 2 \times I_{GT}$ ; $PW = 15\mu\text{s}$ ; $I_T = 110\text{A}$	TYP.	5	$\mu\text{s}$

**Static Characteristics**

Symbol	Test Conditions		Value	Unit
$V_{TM}$	$I_T = 110\text{A}$ ; $t_p = 380\mu\text{s}$	MAX.	1.8	V
$I_{DRM} / I_{RRM}$	$V_{DRM} / V_{RRM}$	$T_J = 25^\circ\text{C}$	10	$\mu\text{A}$
		$T_J = 125^\circ\text{C}$	8	mA

**Thermal Resistances**

Symbol	Parameter	Value	Unit
$R_{\theta(J-C)}$	Junction to case (AC)	1.0	$^\circ\text{C}/\text{W}$

**Figure 1: Normalized DC Gate Trigger Current vs. Junction Temperature**

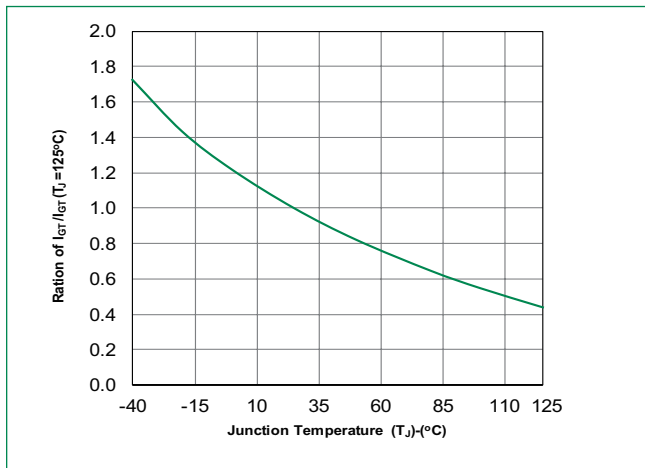

**Figure 2: Normalized DC Gate Trigger Voltage vs. Junction Temperature**

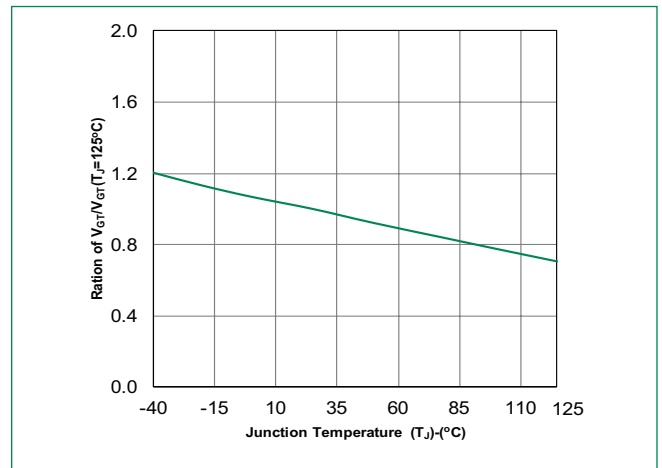

**Figure 3: Normalized DC Holding Current vs. Junction Temperature**

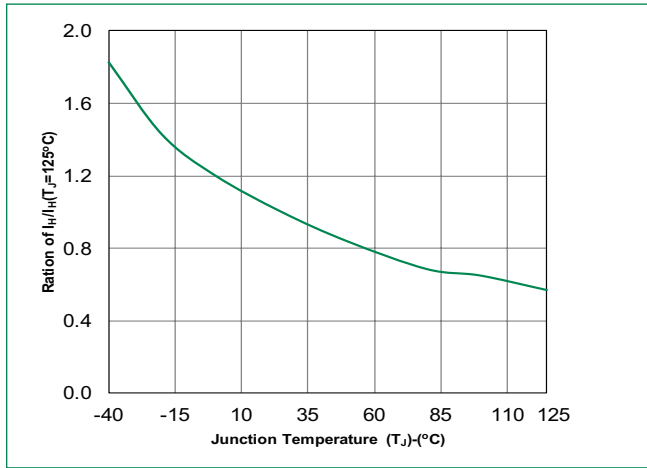

**Figure 4: On-State Current vs. On-State Voltage (Typical)**

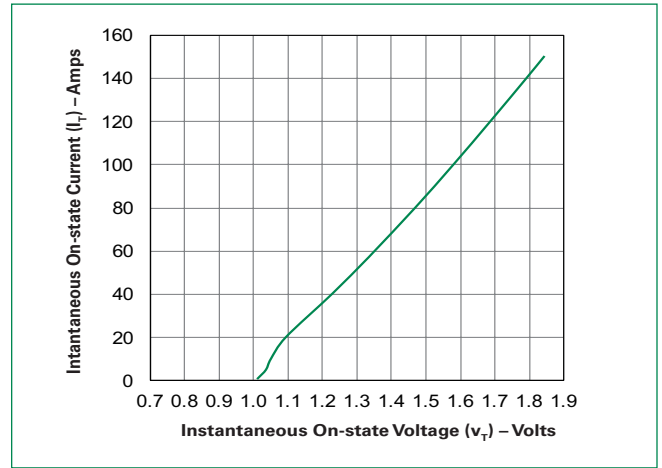

**Figure 5: Power Dissipation (Typical) vs. RMS On-State Current**

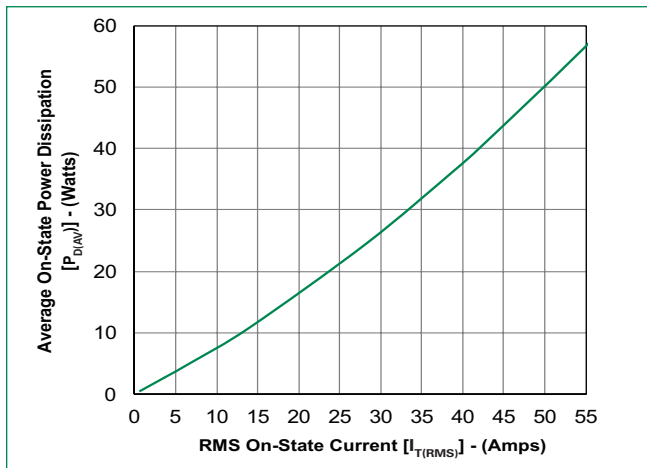

**Figure 6: Maximum Allowable Case Temperature vs. RMS On-State Current**

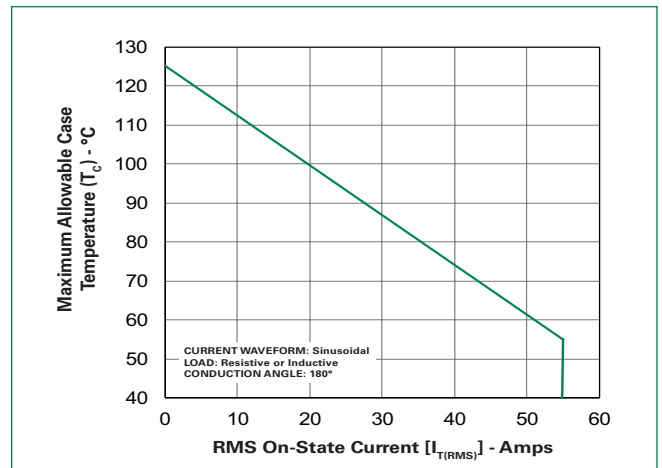

**Figure 7: Maximum Allowable Case Temperature vs. Average On-State Current**

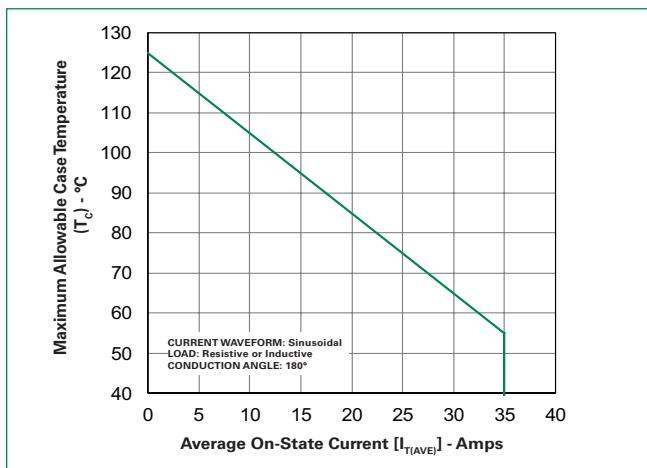

**Figure 8: Surge Peak On-State Current vs. Number of Cycles**

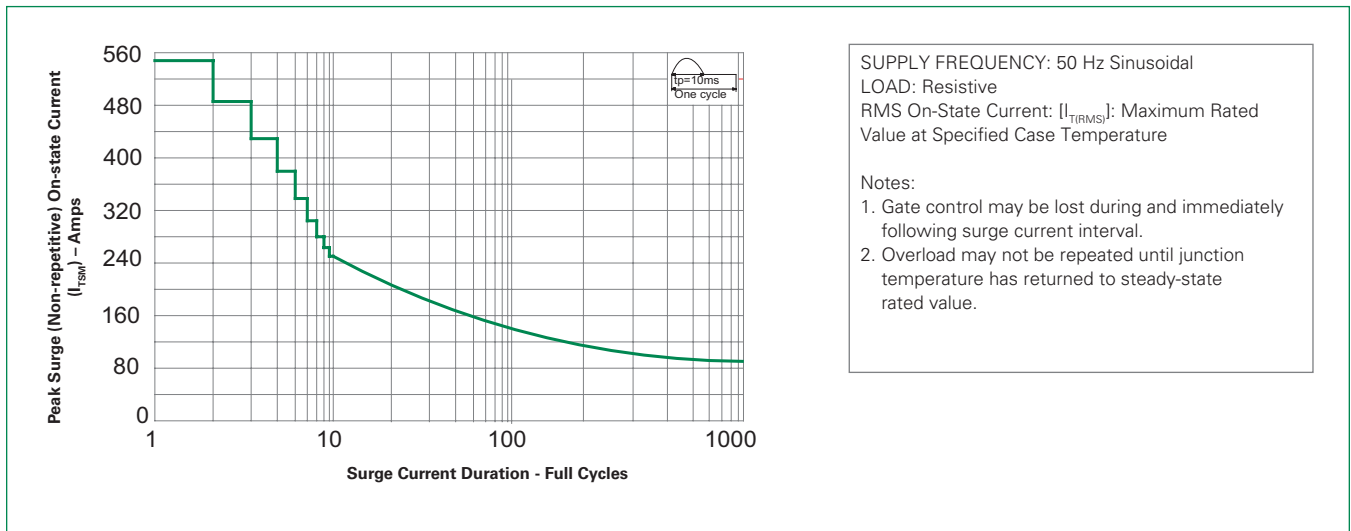

**Design Considerations**

Careful selection of the correct device for the application's operating parameters and environment will go a long way toward extending the operating life of the Thyristor. Good design practice should limit the maximum continuous current through the main terminals to 75% of the device rating. Other ways to ensure long life for a power discrete semiconductor are proper heat sinking and selection of voltage ratings for worst case conditions. Overheating, overvoltage (including dv/dt), and surge currents are the main killers of semiconductors. Correct mounting, soldering, and forming of the leads also help protect against component damage.

**Environmental Specifications**

Test	Specifications and Conditions
<b>AC Blocking</b>	JESD22-A108C, 80% $V_{DRM}$ @125°C for 168 hours
<b>Temperature Cycling</b>	JESD22-A104D, M-1051, 50 cycles; -50°C to +150°C; 15-min dwell-time
<b>Temperature/Humidity</b>	EIA / JEDEC, JESD22-A101 168 hours; 100V - DC: 85°C; 85% rel humidity
<b>Resistance to Solder Heat</b>	JESD22-B106C
<b>Solderability</b>	ANSI/J-STD-002, category 3, Test A

**Dimensions – TO-218AC (KD Package) – Isolated Mounting Tab Common with Center Lead**

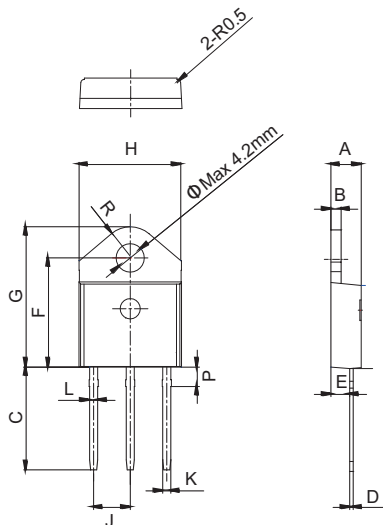

Note: Maximum torque to be applied to mounting tab is 7 in.-lbs. (0.8 Nm).

Dimension	Millimeters			Inches		
	Min.	Typ.	Max.	Min.	Typ.	Max.
A	4.40		4.60	0.173		0.181
B	1.45		1.55	0.057		0.061
C	14.35		15.60	0.565		0.614
D	0.50		0.70	0.020		0.028
E	2.70		2.90	0.106		0.114
F	15.80		16.50	0.622		0.650
G	20.40		21.10	0.803		0.831
H	15.10		15.50	0.594		0.610
J	5.40		5.65	0.213		0.222
K	1.10		1.40	0.043		0.055
L	1.35		1.50	0.053		0.059
P	2.80		3.00	0.110		0.118
R		4.35			0.171	

**Product Selector**

Part Number	Gate Sensitivity	Type	Package
SK655KD	70mA	Standard SCR	TO-218AC

**Packing Options**

Part Number	Marking	Weight	Packing Mode	Base Quantity
SK655KDTP	SK655KD	4.8g	Tube	450 (30 per tube)

**Part Numbering System**

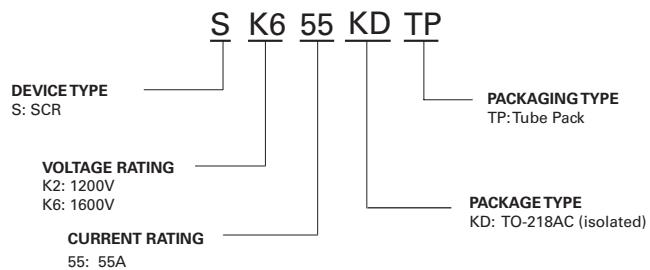

**Part Marking System**

