

DESCRIPTION

Demonstration board DC053A is a complete DC/DC step-up switching regulator using the LT[®]1372 or the LT1377 constant frequency, high efficiency converter in an 8-pin SOIC package. High frequency switching allows the use of

very small inductors, making this all surface mount solution ideal for space conscious systems.

LT, LTC and LT are registered trademarks of Linear Technology Corporation.

PERFORMANCE SUMMARY T_A = 25°C, V_{IN} = 5V, S/S pin open, unless otherwise specified.

PARAMETER	CONDITIONS	MIN	TYP	MAX	UNITS
Output Voltage	R2 = R3 = 1% (Note 1)	11.60	12.04	12.50	V
Output Current	V _{IN} = 5V	250			mA
Input Voltage Range	(Note 2)	2.7		11	V
Switching Frequency	LT1372		500		kHz
	LT1377		1		MHz
Output Ripple Voltage	I _{LOAD} = 250mA		150		mV _{P-P}
	I _{LOAD} = 250mA (Note 3)		80		mV _{P-P}
	V _{OUT2} , I _{LOAD} = 250mA		3		mV _{P-P}
Supply Current	I _{LOAD} = 0A		4.5		mA
Shutdown Supply Current	I _{LOAD} = 0A, V _{S/S} = 0V (Note 4)		100		μA

Note 1: The reference voltage tolerance of the LT1372/LT1377 is $\pm 1.6\%$ over temperature. Output voltage is a worst-case summation of R2, R3 and reference tolerances, plus feedback input current times R3. For a tighter output voltage range, use lower tolerance feedback resistors, or a fixed voltage version of the LT1372/LT1377 (consult Linear Technology Marketing).

Note 2: Increase L1 to 10 μ H for V_{IN} < 4.75V or to 15 μ H for V_{IN} < 3.3V.

Note 3: To reduce output ripple voltage, change C7 to a 2.2 μ F ceramic chip capacitor (Tokin 1E225ZY5U-C203).

Note 4: Single inductor step-up converters have a direct path from the input supply to the output, and therefore draw some supply current even when the LT1372/LT1377 is in shutdown. Shutdown supply current will also increase with the addition of an output load. Applications are available which remove this direct path and reduce shutdown supply current to 30 μ A maximum, independent of loading.

TYPICAL PERFORMANCE CHARACTERISTICS AND BOARD PHOTO

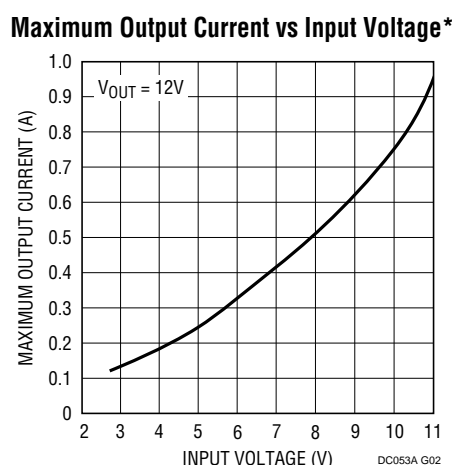
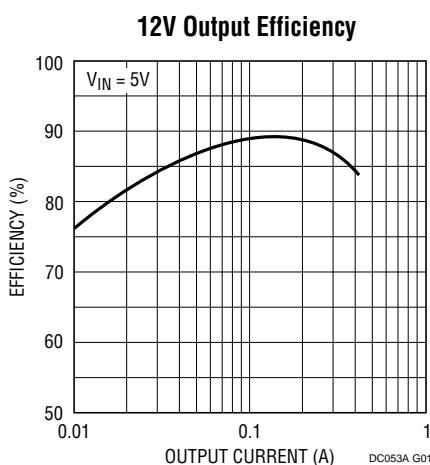

* INCREASE L1 TO 10 μ H FOR V_{IN} < 4.75V
 OR TO 15 μ H FOR V_{IN} < 3.3V

Component Side

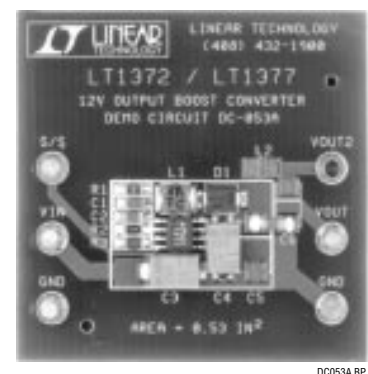

DEMO MANUAL DC053A

PACKAGE A MD SCHEMATIC DIAGRAMS

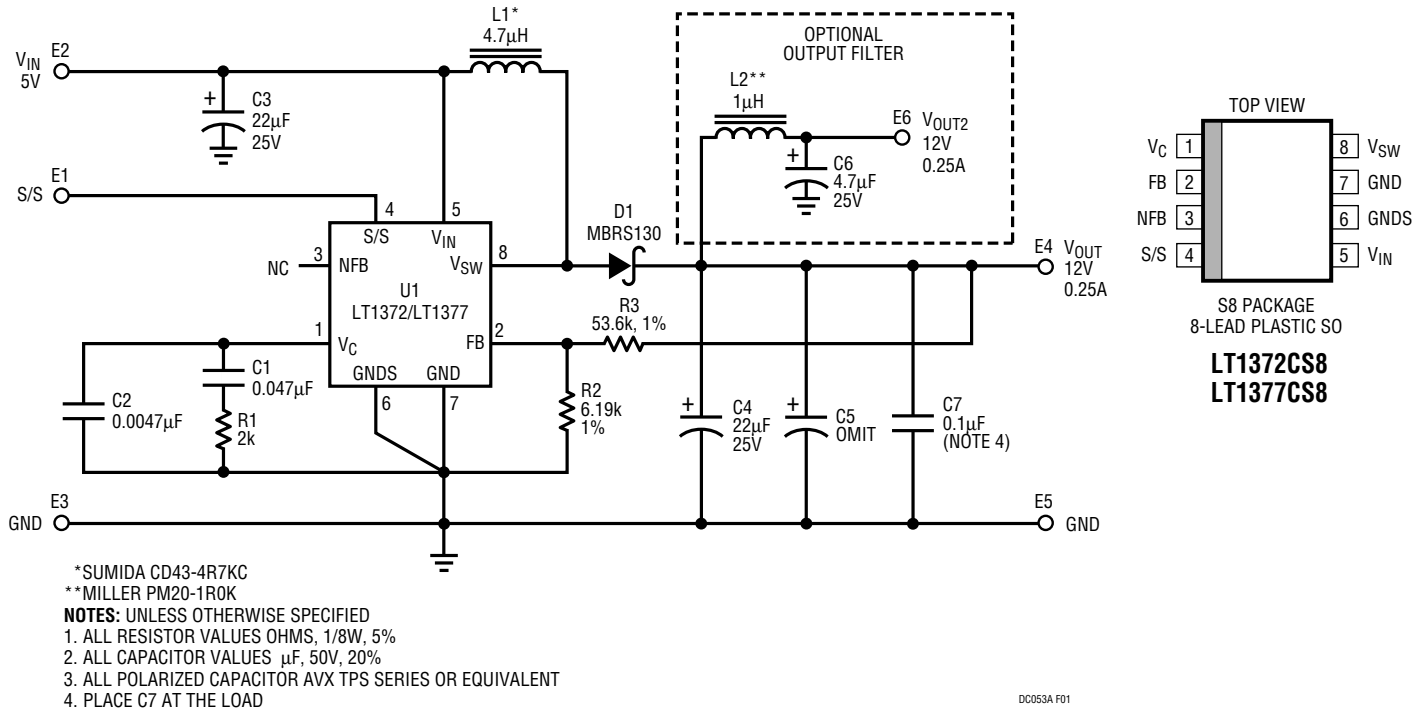

Figure 1. Switching Regulator 5V to 12V, 0.25A; 500kHz for the LT1372 and 1MHz for the LT1377

PARTS LIST

REFERENCE DESIGNATOR	QUANTITY	PART NUMBER	DESCRIPTION	VENDOR	TELEPHONE
C1	1	AVX 12065C473MAT2A	0.047 μ F, 50V, 20%, X7R Capacitor	AVX	(803) 946-0362
C2	1	AVX 12065C472MAT2A	0.0047 μ F, 50V, 20%, X7R Capacitor	AVX	(803) 946-0362
C3, C4	2	AVX TPSD226M025R0200	22 μ F, 25V, 20%, Tantalum Capacitor	AVX	(207) 282-5111
C5, C6	0		Capacitor, Optional (See Text)		
C7	1	AVX 12065C104MAT2A	0.1 μ F, 50V, 20%, X7R Capacitor	AVX	(803) 946-0362
D1	1	MBRS130LT3	30V, 1A, Schottky Diode	Motorola	(602) 244-5768
E1 to E5	5	1502-2	2-Turret, 0.092 Terminal	Keystone	(718) 956-8900
E6	0		Terminal, Optional (See Text)		
L1	1	CD43-4R7KC	4.7 μ H, SMT Inductor	Sumida	(708) 956-0666
L2	0		Inductor, Optional (See Text)		
R1	1	AVX CR32-202J-T	2k, 5%, SMT1206 Resistor	AVX	(803) 946-0524
R2	1	AVX CR32-6191F-T	6.19k, 1%, SMT 1206 Resistor	AVX	(803) 946-0524
R3	1	AVX CR32-5362F-T	53.6k, 1%, SMT-1206 Resistor	AVX	(803) 946-0524
U1*	1	LT1372CS8	SO-8, LT1372, Switching Regulator IC	LTC®	(408) 432-1900
U1*	1	LT1377CS8	SO-8, LT1377, Switching Regulator IC	LTC	(408) 432-1900

*The two demo board versions are:
DC53A-A: U1 = LT1372CS8
DC53A-B: U1 = LT1377CS8

OPERATION

DC053A Operation

This DC053A demonstration board is intended for evaluating the LT1372/LT1377 switching regulator in a typical step-up application. Solid turret terminals are provided for easy connection to test equipment. A device pinout and board schematic are shown in Figure 1. Please refer to the LT1372/LT1377 data sheet for additional specifications and applications information. Also useful is Linear Technology's SwitcherCAD software when creating your own designs.

Hook-Up

Connect the input supply and measurement instruments to the V_{IN} and GND terminals on the left side of the board. The S/S pin (synchronization/shutdown) can be connected to V_{IN} or left open. Connect the output load and measurement instruments to the V_{OUT} and GND terminals on the right side of the board. V_{OUT2} is for evaluating an optional output filter and can be left open.

LT1372/LT1377 Operation

The LT1372/LT1377 are monolithic high frequency current mode switchers. Each device can operate from an input supply range of 2.7V to 25V (DC053A maximum $V_{IN}=11V$), and draws only 4mA quiescent current. The on-chip current limited power switch is guaranteed to 1.5A minimum switch current with a 0.5Ω typical "on" resistance and a 35V minimum breakdown voltage. Running at a fixed frequency of 500kHz (LT1372) or 1MHz (LT1377), switching can also be easily synchronized to a higher frequency by driving the S/S pin with a logic level source. Shutdown is activated by pulling the S/S pin below 0.6V, which reduces device supply current to 30 μ A maximum.

Under normal operating conditions, a 1.245V reference voltage is developed at the Feedback pin. The output voltage is set by R2 and R3, where $V_{OUT}=V_{REF}(1+R3/R2)$. Although not used in this application, the part also has a Negative Feedback pin (NFB) which can be used to set the output voltage of positive-to-negative converters. When in use, a -2.49V reference voltage is developed at the NFB pin.

The V_C pin is the output of the error amplifier. During normal regulator operation this pin sits at a voltage be-

tween 1V (low output current) and 1.9V (high output current). The V_C pin is also where loop frequency compensation is performed with an RC network to ground.

COMPONENTS

Inductors

The inductor is a Sumida CD43-4R7KC, which is a 4.7 μ H unshielded ferrite unit. It was selected for low cost and small physical size. Similar units are available from other manufacturers. There are benefits to higher frequency switching (1MHz LT1377 versus 500kHz LT1372) and higher value inductors. Both higher frequency switching and higher value inductors allow more output current because they reduce peak current in the switch. Both also reduce input ripple voltage and output ripple voltage. An inductor with a closed magnetic path (i.e., E-core or toroid) may also be chosen to reduce the RFI/EMI of the circuit.

Capacitors (and Input/Output Ripple Voltage)

The capacitors on this board are low ESR (Effective Series Resistance) tantalum units specifically designed for switch-mode power supply applications. At these high frequencies, input and output ripple voltages are more a function of the ESR of the capacitor than the capacitance value. For example, at 500kHz a 22 μ F capacitor has a capacitive reactance of only 0.014Ω , which is much lower than the limiting 0.2Ω maximum ESR of the capacitors used. Therefore, if a reduction in input or output ripple voltage is required, use two or more capacitors in parallel instead of a larger value capacitor. If very low output ripple voltage is needed, adding an output LC filter may be a cheaper solution. The output contains very narrow voltage spikes because of the parasitic inductance of the output capacitor. Due to their high frequency nature, the amplitude of the spikes is determined by the ESL (Effective Series Inductance) of the output capacitor. But this also makes them easy to filter. Small 0.1 μ F ceramic chip capacitors work well in reducing the spikes, and if the traces connecting to the load are a few inches or more, the parasitic inductance of the traces combined with any local load bypass capacitor will virtually eliminate the spikes at the load.

DEMO MANUAL DC053A

OPERATION

Diodes

Use diodes designed for switching applications with adequate current rating and fast turn on times, such as Schottky or ultra-fast diodes. In selecting a diode, the basic parameters of interest are forward voltage, maximum reverse voltage, average operating current and peak current. Lower forward voltage yields higher circuit efficiency and lower power dissipation in the diode. The worst-case reverse voltage is equal to the output voltage. The average diode current will be equal to the output current, but the peak diode current can be many times higher than the output current. Except for output short conditions, peak diode current is limited to the switch current limit of 2.4A maximum.

Thermal Considerations

Care should be taken to ensure that the worst-case input voltage and load current conditions do not cause exces-

sive die temperatures. Please consult the LT1372/LT1377 data sheet or Linear Technology's SwitcherCAD software for more information.

PCB Layout

In many cases, the circuit area traces of the demonstration board may be dropped directly into your PCB layout. If not, there are a few things to be aware of with high frequency converter layouts. Keep the traces connecting the Switch (Pin 8), output diode, output capacitor and Ground pin (Pin 7) as short as possible. This will reduce RFI and limit the voltage spikes caused by parasitic inductance. Keep the more sensitive components, mainly the feedback resistors and V_C pin network, away from the high current switching components.

PCB LAYOUT AND FILM

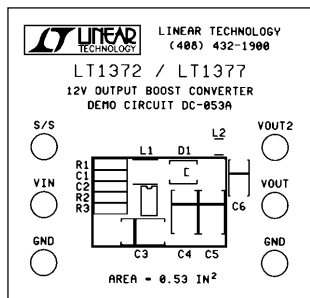

Component Side Silkscreen

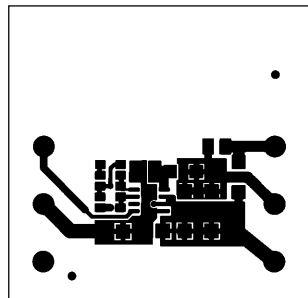

Component Side

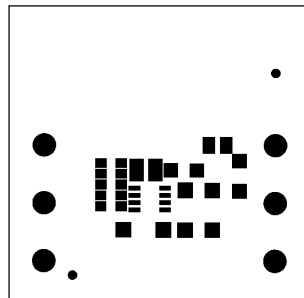

Component Mask

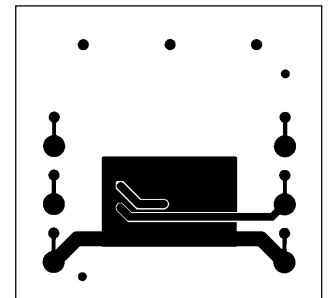

Solder Side

PC FAB DRAWING

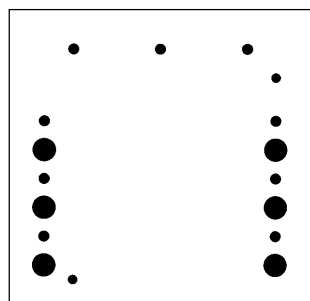

Solder Mask

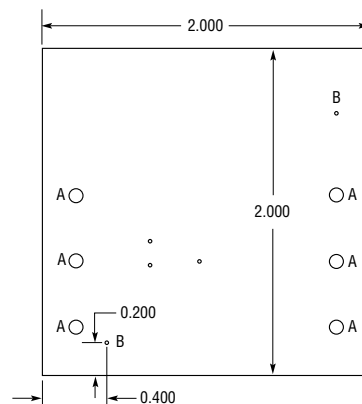

NOTES:

1. FINISHED MATERIAL IS FR4, 0.062 THICK, 2-OZ COPPER
2. PCB WILL BE DOUBLE-SIDED WITH PLATED THROUGH-HOLES
3. PTH SIZES AFTER PLATING, 0.001 MIN WALL THICKNESS
4. SOLDER MASK BOTH SIDES USING PC401 OR EQUIVALENT
5. SILKSCREEN COMPONENT SIDE USING WHITE NONCONDUCTIVE INK
6. ALL DIMENSIONS IN INCHES, ± 0.005
7. ALL HOLE SIZES AFTER PLATING, -0 TO 0.003 MAX

HOLE CHART

SYMBOL	DIAMETER	QTY	PLT
NONE	0.020	3	YES
A	0.094	6	YES
B	0.062	2	NO
TOTAL HOLES 11			

DC053A FAB