

Power Metal Strip® Resistors, High Temperature (275 °C), High Power, Low Value, Surface Mount, 4-Terminal

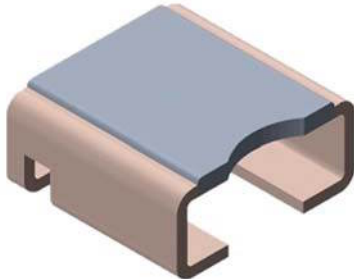

FEATURES

- 4-terminal design allows for 1 % tolerance down to 0.002 Ω
- High power-to-footprint size ratio
- Ideal for all types of current sensing, voltage division and pulse applications, including switching and linear power supplies, instruments, power amplifiers and shunts
- Proprietary processing technique produces extremely low resistance values, down to 0.0005 Ω
- All welded construction
- Solid metal nickel-chrome resistive element with low TCR (< 20 ppm/°C)
- Very low inductance 0.5 nH to 5 nH
- Low thermal EMF (< 3 μV/°C)
- AEC-Q200 qualified available ⁽¹⁾
- Material categorization: for definitions of compliance please see www.vishay.com/doc?99912

 AUTOMOTIVE
GRADE
Available

RoHS
COMPLIANT
HALOGEN
FREE
GREEN
(5-2008)

Note

⁽¹⁾ Flame retardance test may not be applicable to some resistor technologies.

STANDARD ELECTRICAL SPECIFICATIONS						
GLOBAL MODEL	SIZE	POWER RATING $P_{70^\circ\text{C}}$ W	TOLERANCE ± %	RESISTANCE VALUE RANGE Ω	RESISTANCE VALUES CURRENTLY AVAILABLE ⁽²⁾ Ω	WEIGHT (typical) g/1000 pieces
WSLT2726	2726	3.0	1.0	0.3m to 5m	2m, 3m, 4m, 5m	420

Notes

- Power rating depends on the max. temperature at the solder point, component placement density and the substrate material.
- Part marking: Model, value, tolerance, date code.
- ⁽²⁾ Other values may be available, contact factory.

TECHNICAL SPECIFICATIONS		
PARAMETER	UNIT	RESISTOR CHARACTERISTICS
Temperature coefficient	ppm/°C	± 75 over temperature of +20 °C to +60 °C
Operating temperature range	°C	-65 to +275
Maximum continuous current	V	$(P \times R)^{1/2}$

GLOBAL PART NUMBER INFORMATION																	
Global Part Numbering: WSLT27265L000FEA (WSLT2726, 0.005 Ω, ± 1 %)																	
W	S	L	T	2	7	2	6	5	L	0	0	0	F	E	A		
GLOBAL MODEL		RESISTANCE VALUE			TOLERANCE CODE			PACKAGING CODE			SPECIAL						
WSLT2726		L = mΩ 2L000 = 0.002 Ω 3L000 = 0.003 Ω 4L000 = 0.004 Ω 5L000 = 0.005 Ω			F = ± 1.0 %			EA = Lead (Pb)-free, tape/reel EK = Lead (Pb)-free, bulk			(Dash number) (up to 2 digits) From 1 to 99 as applicable						

DIMENSIONS

MODEL	DIMENSIONS in inches (millimeters)							
	L	W	H	R (REF.)	S	T	U	N
WSLT2726	0.272 ± 0.008 (6.9 ± 0.2)	0.260 + 0.012/- 0.008 (6.6 + 0.3/- 0.2)	0.117 ± 0.008 (3.0 ± 0.2)	0.198 (5.0)	0.028 ± 0.004 (0.7 ± 0.1)	0.016 ± 0.002 (0.4 ± 0.05)	0.078 ± 0.004 (2.0 ± 0.1)	0.039 ± 0.006 (0.99 ± 0.15)

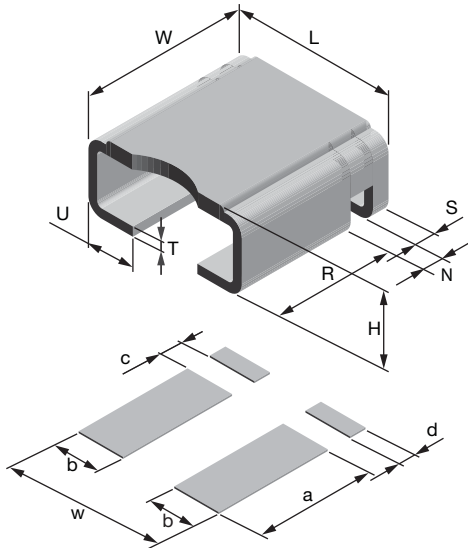

MODEL	SOLDER PAD DIMENSIONS in inches (millimeters)				
	a	b	c	d	w
WSLT2726	0.220 (5.6)	0.096 (2.44)	0.035 (0.89)	0.035 (0.89)	0.290 (7.4)

MODEL	RESISTANCE VALUE (mΩ)	ELEMENT MATERIAL
WSLT2726	2.0	Ni-Cr
	3.0	Ni-Cr
	4.0	Ni-Cr
	5.0	Ni-Cr

DERATING

PERFORMANCE		
TEST	CONDITIONS OF TEST	TEST LIMITS
Thermal shock	-55 °C to +150 °C, 1000 cycles, 15 min at each extreme	± (0.5 %) ΔR
Short time overload	0.3 mΩ, 0.5 mΩ, 2 mΩ and 3 mΩ - 5x rated power for 5 s 4 mΩ and 5 mΩ - 3x rated power for 5 s	± (0.5 %) ΔR
Low temperature operation	-65 °C for 45 min	± (0.5 %) ΔR
High temperature exposure	1000 h at +275 °C	± (1.0 %) ΔR
Bias humidity	+85 °C, 85 % RH, 10 % bias, 1000 h	± (0.5 %) ΔR
Mechanical shock	100 g's for 6 ms, 5 pulses	± (0.5 %) ΔR
Vibration	Frequency varied 10 Hz to 2000 Hz in 1 min, 3 directions, 12 h	± (0.5 %) ΔR
Load life	1000 h at +70 °C, 1.5 h "ON", 0.5 h "OFF"	± (1.0 %) ΔR
Resistance to solder heat	+260 °C solder, 10 s to 12 s dwell, 25 mm/s emergence	± (0.5 %) ΔR
Moisture resistance	MIL-STD-202, method 106, 0 % power, 7b not required	± (0.5 %) ΔR

PACKAGING				
MODEL	REEL			
	TAPE WIDTH	DIAMETER	PIECES/REEL	CODE
WSLT2726	16 mm/embossed plastic	330 mm/13"	1500	EA

Note

- Embossed Carrier Tape per EIA-481.



Disclaimer

ALL PRODUCT, PRODUCT SPECIFICATIONS AND DATA ARE SUBJECT TO CHANGE WITHOUT NOTICE TO IMPROVE RELIABILITY, FUNCTION OR DESIGN OR OTHERWISE.

Vishay Intertechnology, Inc., its affiliates, agents, and employees, and all persons acting on its or their behalf (collectively, "Vishay"), disclaim any and all liability for any errors, inaccuracies or incompleteness contained in any datasheet or in any other disclosure relating to any product.

Vishay makes no warranty, representation or guarantee regarding the suitability of the products for any particular purpose or the continuing production of any product. To the maximum extent permitted by applicable law, Vishay disclaims (i) any and all liability arising out of the application or use of any product, (ii) any and all liability, including without limitation special, consequential or incidental damages, and (iii) any and all implied warranties, including warranties of fitness for particular purpose, non-infringement and merchantability.

Statements regarding the suitability of products for certain types of applications are based on Vishay's knowledge of typical requirements that are often placed on Vishay products in generic applications. Such statements are not binding statements about the suitability of products for a particular application. It is the customer's responsibility to validate that a particular product with the properties described in the product specification is suitable for use in a particular application. Parameters provided in datasheets and/or specifications may vary in different applications and performance may vary over time. All operating parameters, including typical parameters, must be validated for each customer application by the customer's technical experts. Product specifications do not expand or otherwise modify Vishay's terms and conditions of purchase, including but not limited to the warranty expressed therein.

Except as expressly indicated in writing, Vishay products are not designed for use in medical, life-saving, or life-sustaining applications or for any other application in which the failure of the Vishay product could result in personal injury or death. Customers using or selling Vishay products not expressly indicated for use in such applications do so at their own risk. Please contact authorized Vishay personnel to obtain written terms and conditions regarding products designed for such applications.

No license, express or implied, by estoppel or otherwise, to any intellectual property rights is granted by this document or by any conduct of Vishay. Product names and markings noted herein may be trademarks of their respective owners.

Material Category Policy

Vishay Intertechnology, Inc. hereby certifies that all its products that are identified as RoHS-Compliant fulfill the definitions and restrictions defined under Directive 2011/65/EU of The European Parliament and of the Council of June 8, 2011 on the restriction of the use of certain hazardous substances in electrical and electronic equipment (EEE) - recast, unless otherwise specified as non-compliant.

Please note that some Vishay documentation may still make reference to RoHS Directive 2002/95/EC. We confirm that all the products identified as being compliant to Directive 2002/95/EC conform to Directive 2011/65/EU.

Vishay Intertechnology, Inc. hereby certifies that all its products that are identified as Halogen-Free follow Halogen-Free requirements as per JEDEC JS709A standards. Please note that some Vishay documentation may still make reference to the IEC 61249-2-21 definition. We confirm that all the products identified as being compliant to IEC 61249-2-21 conform to JEDEC JS709A standards.