

## Automotive / Appliance control - sensor

# 10 mm carbon potentiometer PT10



## Mechanical specifications

Mechanical rotation angle <sup>1</sup>	235° ± 5°
Electrical rotation angle <sup>2</sup>	220° ± 20°
Torque rotational stop	0.4 to 2 Ncm. (0.6 to 2.7 in-oz) > 5 Ncm. (<7 in-oz)
Life <sup>3</sup>	up to 100K cycles

<sup>1</sup> 360° version available: ST10

<sup>2</sup> 333° version available: ST10

<sup>3</sup> Others: check availability.

## Electrical specifications

Range of values <sup>1</sup>	100Ω ≤ Rn ≤ 5MΩ (Decad. 1.0 - 2.0 - 2.2 - 2.5 - 4.7 - 5.0)
Tolerance <sup>1</sup>	100Ω ≤ Rn ≤ 1MΩ ± 20% 1MΩ ≤ Rn ≤ 5MΩ ± 30%
Max. voltage	200 VDC (lin) 100 VDC (no lin)
Nominal power 50°C (122°F) <sup>3</sup>	0.15 W (lin) 0.07 W (no lin)
Taper	Linear ; Log; Alog. (Log. & Alog. only Rn ≥ 1K)
Residual resistance	≤ 0.5% Rn (5Ω min.)
Equivalent noise resistance	≤ 3% Rn (3Ω min.)
Operating temperature <sup>2,3</sup>	-25°C to +70°C (-13°F to + 158°F)

<sup>1</sup> Others: check availability. <sup>2</sup> Up to 85°C depending on application.

<sup>3</sup> For higher specifications please visit our PTC10 series.

For reflow soldering capable models please see our PS10 datasheet.

## Main features

- Carbon resistive element.
- Dust proof enclosure.
- Polyester substrate.
- Wiper positioned at initial, 50% or fully clockwise.

Also upon request:

- Available in magazines for automatic insertion.
- Long life model for low-cost control potentiometer applications.
- Self-extinguishable plastic UL 94V-0.
- Cut track option (open circuit).
- Special tapers.
- Mechanical detents.
- Low torque version.
- Special switch option.
- 3% Linearity and 100K cycles mechanical life.

## Description

The PT10 potentiometer offers control where frequent adjustment is required. The shaftless design allows for employment of different engagement mechanisms, such as a customized shaft, a motor control or a human interface adjustment.

This potentiometer can also control variable outputs including frequency, change in motor speed or volume.

Typical applications include test and measurement equipment, consumer electronics, appliances, small engines, robotics, motion controllers, and medical equipment control panels.

This datasheet shows you the basics of the PT10 potentiometer that is quite versatile and easy to tailor. Do not hesitate to contact Piher for advice.

## Piher Sensing Systems

Our product competencies and services:  
Potentiometers | Position / Angle sensors | Rotary switches | Incremental encoders  
Printed circuit resistors | Mechatronics | Value added assemblies



# Automotive / Appliance control - sensor

## 10 mm carbon potentiometer PT10



**Rotors (Default delivery is at initial position. Wipers are shown positioned at 50% for the picture)**

Without shaft or knob.



**L = Screwdriver    M = Hexagonal    G = Hexagonal    K = Cross slot    R    B**

All rotors are thru-hole.

With inserted shaft.



With knob/humbwheel inserted



**Y = Adjustable from terminal side (default knob is 5034).**

**Z = Adjustable from collector side (default knob is 5034).**

### Mounting methods. Dimensions

Download 3D - STEP files here: <https://piher.net/piher/?p=905>

V = horizontal mounting – vertical adjustment

H = vertical mounting – horizontal adjustment



### Piher Sensing Systems

Our product competencies and services:  
Potentiometers | Position / Angle sensors | Rotary switches | Incremental encoders  
Printed circuit resistors | Mechatronics | Value added assemblies



## Automotive / Appliance control - sensor

# 10 mm carbon potentiometer PT10

### Standard values - tolerances

Resistance $\Omega$	100	200	220	250	470	500	1K	2K	2.2K	2.5K	4.7K	5K	10K	20K	22K	25K	47K	50K	100K	200K	220K	250K	470K	500K	1M	2M	2.5M	4.7M	5M
How to order code	101	201	221	251	471	501	102	202	222	252	472	502	103	203	223	253	473	503	104	204	224	254	474	504	105	205	255	475	505
Standard tolerance	20%																								30%				

### Tapers



### Detents



Detents detail.  
(7 detents example)



Relative detent positions along the total mechanical travel. Unless otherwise specified the detents are evenly spaced (using the end points as reference)

Standard mechanical life is 500 cycles.

Long life versions are available under request and have the following characteristics at T<sup>a</sup>:

- Potentiometers with 1 to 3 detents: up to 10K cycles
- Potentiometers with 4 and more detents: up to 5K cycles

Please consult your nearest Piher supplier if unique non-overlapping values at each detent position or LOG/ALOG tapers are required.

Different output voltage values can be matched at each detent position (see next page).

Detent torque can vary from 1.2 to 2.5 times the standard potentiometer torque.

For V05 mounting: check availability.

For more than 16 detents versions please contact your nearest PIHER authorised distributor.

For custom voltage outputs in any detent position see page 6.

## Piher Sensing Systems

Our product competencies and services:  
Potentiometers | Position / Angle sensors | Rotary switches | Incremental encoders  
Printed circuit resistors | Mechatronics | Value added assemblies

## Automotive / Appliance control - sensor

# 10 mm carbon potentiometer PT10

### Stepped outputs

Constant value zones can be combined with strategically located stops matching the flat areas of the output. If you require this feature, please, send us your requirements to [sales@piher.net](mailto:sales@piher.net)

#### Stepped outputs version example (10 steps version):



#### Improved repeatability

By combining the constant value zones with the detents, engineers can align the same voltage values with each of the detent stops when rotating the control both forward and backward.

This provides clear mechanical positions that are not only repeatable, but perfectly aligned electrical outputs at each of the (detent) angles.

Piher's detents also prevent output values from changing due to vibration or accidental rotor movements, furthering reliable control consistency.



### Stepped outputs

PIHER's potentiometers can feature special stepped outputs or 'constant voltage zones' for the 10mm and 15mm product families.

These constant voltage zones can be combined with PIHER's mechanical detents to provide exact alignment between the electrical output (flat areas) and the mechanical detent position. The result is a higher level of precision in controlling lighting, temperature, motor or other electronic control systems.

In addition to established catalogue detent configurations, we will design and manufacture any other configuration on our tried-and-tested carbon/cermet & THM/SMD potentiometer technology and processes.

With its precise control capabilities, our 10mm and 15mm potentiometers series are well suited for many consumer applications such as lighting (dimmers), power hand tools, relays, timers and HVAC systems.

#### Design tip. Cost-effectiveness

Absolute encoders can easily be replaced connecting the potentiometer to the microprocessor's analogue input.



#### Main advantages

- ✓ Unique, non-overlapping values at each stop (detent position)
- ✓ It prevents changes in the output value due to light vibration or accidental rotor micro-movements
- ✓ Fully customisable according to customer's needs
- ✓ Cost effective replacement for absolute encoders

## Automotive / Appliance control - sensor

# 10 mm carbon potentiometer PT10

### Shafts

For G and M rotor types, top view.



Fig. 1 / Ref. 5016



Fig. 2 / Ref. 5053



Fig. 3 / Ref. 5012



Fig. 4 / Ref. 6053

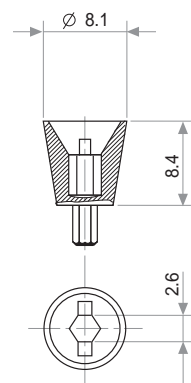

Fig. 6 / Ref. 5035



Fig. 7 / Ref. 5115



Fig. 8 / Ref. 5116



Fig. 9 / Ref. 5119

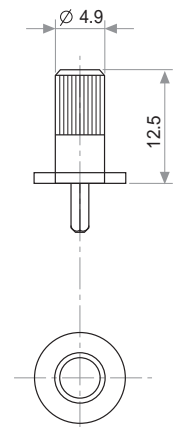

Fig. 10 / Ref. 5120



Fig. 12 / Ref. 6052

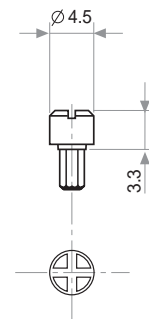

Fig. 14 / Ref. 5055

## Piher Sensing Systems

Our product competencies and services:  
Potentiometers | Position / Angle sensors | Rotary switches | Incremental encoders  
Printed circuit resistors | Mechatronics | Value added assemblies

## Automotive / Appliance control - sensor

# 10 mm carbon potentiometer PT10

### Knobs/thumbwheels

For G and M rotor types, top view.



Fig. 5 / Ref. 5034

Fig. 15 / Ref. 6008

Fig. 16 / Ref. 5039

Fig. 17 / Ref. 5062

2- GANG Plastic Knob/ Plastic Shaft

Numbered Thumbwheel



Fig. 18 / Ref. 6064



Marking: configurable number of positions.  
Example of four positions marking pictured

For R rotor type only

Upon request.

By default, shafts, knobs & thumbwheels are delivered unassembled.

Mounted shafts, knobs & thumbwheels are delivered at random position but can be delivered at specific positions too (a drawing must be provided by the customer).

If you need the shaft or knob to be delivered assembled from the factory, please select the appropriate rotor in the part number: X, W, Y or Z.

The plastic color can be stated in the part number. Non flammable plastic can be ordered too.

If the potentiometer is ordered with non flammable plastic materials (UL 94V0) then the shaft or knob will be delivered with non flammable plastic too.

If you wish to use your own plastic shaft/knob/actuator, please, contact Piher for advice about compatible materials.

### Positioning

Std. Position = CCW. Other delivery positions upon request.



## Piher Sensing Systems

Our product competencies and services:  
Potentiometers | Position / Angle sensors | Rotary switches | Incremental encoders  
Printed circuit resistors | Mechatronics | Value added assemblies



## Automotive / Appliance control - sensor

# 10 mm carbon potentiometer PT10

### Switch versions

They can be delivered with or without detents/stops.

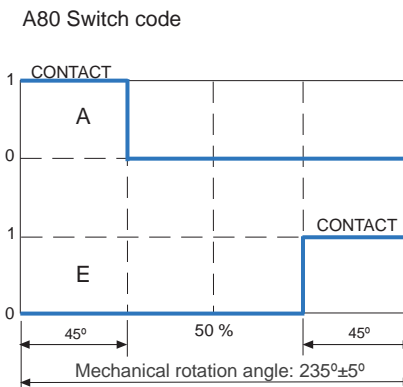
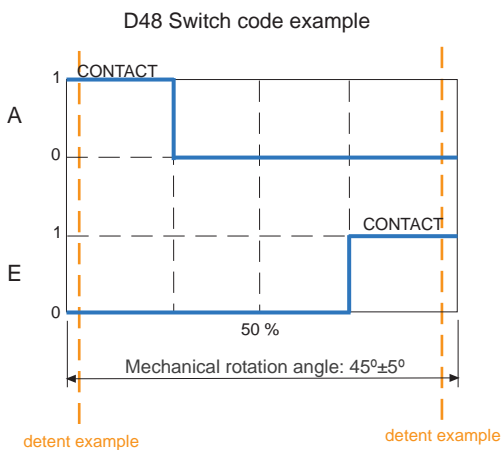

### Switch standard specs.

Power Rating:  
24V / 15mA  
ON position resistance:  
≤ 5 Ω  
Insulation Resistance:  
≥ 30 MΩ

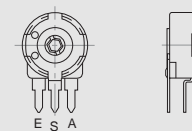

(D48, rotor shown at final position)

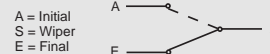

### Cut track (open circuit feature)

CCW on-off (A)

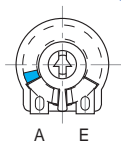

PCI  
Cut track at the beginning of the travel.

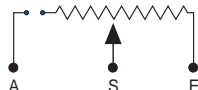

PCF  
Cut track at the end of the travel

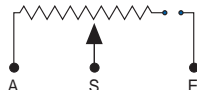

CW on-off (E)

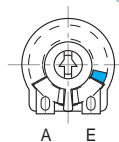

A = Initial S = Wiper E = Final. Other configurations available upon request.

### Packaging

Default packaging is bulk (boxes).



Model	Units per box
Without shaft	1000 (80 x 85 x 185 mm.)
With thumbwheel	800 (80 x 85 x 185 mm.)
With shaft	400 (80 x 85 x 185 mm.)

Magazines for automatic insertion are available with 50pcs per magazine.

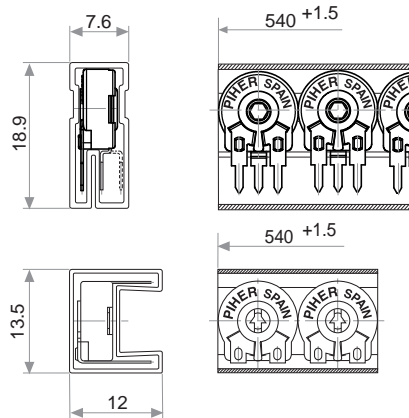

Magazines for PT10 H01 and H05  
Also crimped term. H02

Magazines for PT10 V  
Also crimped term. V11

### Piher Sensing Systems

Our product competencies and services:  
Potentiometers | Position / Angle sensors | Rotary switches | Incremental encoders  
Printed circuit resistors | Mechatronics | Value added assemblies

## Automotive / Appliance control - sensor

# 10 mm carbon potentiometer PT10

## Tests

### Typical variations

Electrical life	1000 h. @ 50°C; 0.15 W	±5 %
Mechanical life (cycles)	1000 @ 10 CPM ... 15 CPM	±3 % (Rn < 1 MΩ)
Temperature coefficient	-25°C; +70°C	±300 ppm (Rn < 100 KΩ)
Thermal cycling	16 h. @ 85°C; 2h. @ -25°C	±2.5 %
Damp heat	500 h. @ 40°C @ 95% HR	±5 %
Vibration (for each plane x,y,z)	2 h. @ 10 Hz. ... 55 Hz.	±2 %

Out of range values may not comply with these results.  
For other tests or the full range of tests, please, contact us.

## Disclaimer

The product information in this catalogue is for reference purposes. Please consult for the most up to date and accurate design information.

Piher Sensors & Controls S.A., its affiliates, agents, and employees, and all persons acting on its or their behalf (collectively, "Piher"), disclaim any and all liability for any errors, inaccuracies or incompleteness contained herein or in any other disclosure relating to any product described herein.

Piher disclaims any and all liability arising out of the use or application of any product described herein or of any information provided herein to the maximum extent permitted by law. The product specifications do not expand or otherwise modify Piher's terms and conditions of sale, including but not limited to the warranty expressed therein, which apply to these products.

No licence, express or implied, by estoppel or otherwise, to any intellectual property rights is granted by this document or by any conduct of Piher.

The products shown herein are not designed for use in medical, life-saving, or life-sustaining applications unless otherwise expressly indicated. Customers using or selling Piher products not expressly indicated for use in such applications do so entirely at their own risk and agree to fully indemnify Piher for any damages arising or resulting from such use or sale. Please contact authorised Piher personnel to obtain written terms and conditions regarding products designed for such applications.

Product names and markings noted herein may be trademarks of their respective owners.

Information contained in and/or attached to this catalogue may be subject to export control regulations of the European Community, USA, or other countries. Each recipient of this document is responsible to ensure that usage and/or transfer of any information contained in this document complies with all relevant export control regulations. If you are in any doubt about the export control restrictions that apply to this information, please contact the sender immediately. For any Piher International Corp. Exports, Note: All products / technologies are EAR99 Classified commodities. Exports from the United States are in accordance with the Export Administration Regulations. Diversion contrary to US law is prohibited.

Piher is an Amphenol™ company.



All Piher products can be adapted to meet customer's requirements.  
Due to continuous process improvement, specifications are subject to change without notice.  
Please always use the datasheets published at our website [www.piher.net](http://www.piher.net) for the most up-to-date information.

rev260619

## Piher Sensing Systems

Our product competencies and services:  
Potentiometers | Position / Angle sensors | Rotary switches | Incremental encoders  
Printed circuit resistors | Mechatronics | Value added assemblies

## Recommended connections

Recommended connection scheme for Piher's position sensors (voltage divider)



## Power rating curve

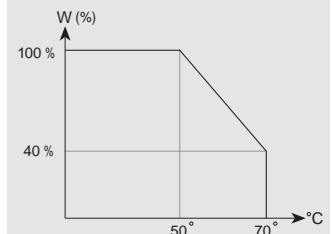

For higher nominal power please visit our PTC-10 cermet potentiometer.

## Contact

Piher Sensors & Controls SA  
Poligono Industrial Municipal  
Vial T2, 22,  
31500 Tudela - Spain.  
t. +34-948-820450  
f. +34-948-824050

[sales@piher.net](mailto:sales@piher.net)

[www.piher.net](http://www.piher.net)



Online product configurator