

SHARP

Electronic Components
January 2012

For Your Creative Products

ELECTRONIC COMPONENTS



<http://sharp-world.com/products/device/>

CONTENTS

Sharp Efforts Towards a Green Society	2
Developing Devices with High Environmental Performance.....	4
Raising the Level of Environmental Performance in Factories ...	5

TFT LCD 6

LCD Modules.....	6
------------------	---

LSI CMOS IMAGE SENSORS/CCDs 8

CMOS Camera Modules Road Map.....	8
CMOS Camera Modules	9
Road Map for High-resolution CCDs for Digital Cameras	10
High-resolution CCDs.....	11
1/3-type CCDs.....	11
1/3.8-type CCD.....	11
1/4-type CCDs.....	11
CCD Peripheral ICs/LSIs.....	12

LSI Analog LSIs FOR LCDs/ANALOG ICs 17

For Notebook PCs, PC Monitors and LCD TVs.....	17
For Mobile Devices.....	18
Power Supply ICs for TFT-LCDs.....	18

LSI SYSTEM LSIs 19

System LSIs	19
Graphic Display Module with LCDs	19
One-chip Graphic Controller.....	20
IrSimple™ Communications Series.....	21

REG RF Analog POWER DEVICES/ANALOG ICs 22

Low Power-Loss Voltage Regulators	22
Surface Mount Type Low Power-Loss Voltage Regulators	22
Surface Mount Type Chopper Regulators (DC-DC Converters).....	25
Chopper Regulators (DC-DC Converters).....	26
DC-DC Converter Module with Built-in Coil.....	26
Power Supply ICs for CCDs/CCD Camera Modules	27
LED Drivers	28
AC-DC Conversion Type ICs for LED Lighting.....	30
AC Direct Type ICs for LED Lighting.....	30
Power Supply Modules for LED Lighting	30
Power Amplifiers for Wireless LAN.....	30
Fail Safe ICs	31
Solar Modules for Mobile Devices	31

LSI REG PACKAGES 32

CSP (Chip Size Package)	32
SiP (System in Package).....	33
SOF (System On Film)	35
Package Lineup.....	36

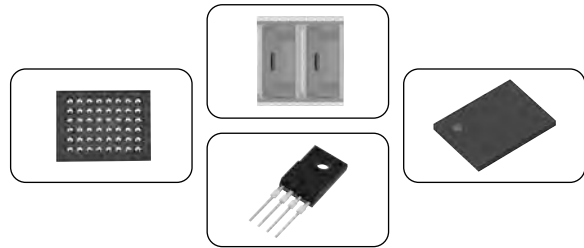

OPTO OPTOELECTRONICS 43

Photocoupler Lineup	43
Photocouplers	
Phototransistor Output Type	44
OPIC Output.....	48
Phototriac Coupler Lineup.....	50
Phototriac Couplers.....	51
Solid State Relay Lineup	53
Solid State Relays	
DIP type.....	54
SiP type.....	55
Photointerrupter Lineup.....	57
Photointerrupters <Transmissive type>	58
Single Phototransistor Output	58
Darlington Phototransistor Output.....	60
OPIC Type	60
Photointerrupters <Reflective type>	62
Single Phototransistor Output	62
OPIC Output.....	63
Photointerrupters for Specific Applications.....	64
Transmissive Type.....	64
Reflective Type	64
Proximity Sensor	65
Proximity Sensor with Integrated Ambient Light Sensor	66
Ambient Light Sensors	67
OPIC Light Detectors	68
Phototransistor Lineup	70
Phototransistors	71
PIN Photodiodes	72
Infrared Emitting Diode Lineup.....	73
Infrared Emitting Diodes.....	73
Optical-Electric Sensor Lineup.....	74
Distance Measuring Sensors	75
Wide Angle Sensors.....	77
Paper Size Sensors.....	77
High-Precision Displacement Sensor.....	77

Dust Sensor Unit	78
Color Toner Concentration (Deposition Amount) Sensors.....	78
Fiber Optics Lineup for Audio Equipment.....	79
Fiber Optic Transmitters	80
Fiber Optic Receivers.....	80

LED LEDs **81**

High-Luminosity Surface Mount LEDs.....	81
Surface Mount LEDs	81
High-Luminosity White Surface Mount LEDs	82
High-Luminosity Surface Mount LEDs (RGB 3-color)	82
ZENIGATA LEDs for Lighting.....	83
Surface Mount LEDs for Lighting.....	85
Surface Mount LEDs for Lighting (RGB 3-color)	85
LEDs for LCD Backlight.....	86

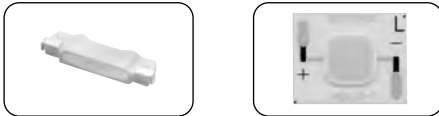

LASER LASER DIODES **87**

Laser Diodes	87
--------------------	----

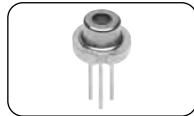

RF RF COMPONENTS **89**

Europe: LNBS for Satellite Broadcast	89
Japan/Asia/Australia: LNBS for CS Digital Satellite Broadcast	90
Japan: LNBS for BS/CS 110° Satellite Broadcast.....	90
Digital DBS Front-End Units	91
Front-End Units for ISDB-T/DVB-T/CTTB/CATV and Digital Satellite.....	92
Front-End Units for ISDB-T/DVB-T/CTTB/CATV	93
Front-End Units for Digital Terrestrial and Analog Terrestrial Broadcasting.....	94
Full-Seg Tuner Module for Diversity Reception	95
MPEG Module	95
MPEG Module with Video Recording Function	96
One-Seg Tuner Module	96
Embedded Wireless LAN-Bluetooth Combo Module.....	97

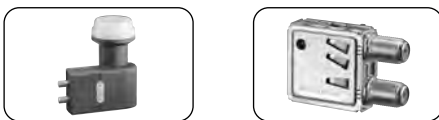

IR IR DEVICES **98**

Infrared Data Communication Device Lineup.....	98
Infrared Data Communication Devices.....	99
IR Detecting Unit for Remote Control Lineup (Classified by Form)	101
IR Detecting Units for Remote Control	102

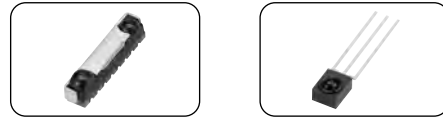

PCB PRINTED CIRCUIT BOARDS **103**

Advanced Flex Printed Circuit Boards.....	103
Flexible Printed Circuit Boards	105



UNIT PICKUPS **106**

DVD Pickup for Automotive Use	106
-------------------------------------	-----

INDEX	107
NOTICE	113

Sharp Efforts Towards a Green Society

Based on its fiscal 2010 corporate vision of becoming an “Eco-Positive Company,” the entire Sharp Group is working as one towards realizing a green society.

● Basic Environmental Philosophy ●

Creating an Environmentally Conscious Company with Sincerity and Creativity

● The Sharp Group Charter of Corporate Behavior ●

Contribution to Conservation of the Global Environment

The Sharp Group will make efforts to further contribute to global environmental conservation by strengthening our development of proprietary technologies for protecting the global environment, and by carrying out business activities in an environmentally conscious manner.

● The Sharp Code of Conduct ●

Contribution to Conservation of the Global Environment

1. To Conserve the Environment:

- ① We will comply with all applicable environmental laws, regulations, and regional agreements, and make voluntary efforts to practice effective use and saving of resources and energy, in the recognition that global environmental conservation is an essential facet of corporate and individual pursuits.
- ② We will work aggressively to reduce greenhouse gas emissions in all business activities, in order to contribute to the prevention of global warming.
- ③ To deal with environmental issues on a global scale, we will promote the sharing and practical application of energy-saving actions and environmental conservation technologies among the Sharp Group companies in each country and work to contribute to reducing environmental load.
- ④ We recognize that maintaining an eco-system where diverse living organisms coexist brings about a rich environment in which both corporations and individuals can operate and live. To that end, we will work aggressively to conserve biodiversity and for its sustainable use.
- ⑤ In order to promote communication with local residents and other stakeholders, we will engage in acquiring environmental information at an international level, and providing internal reports thereof.

2. To Develop Environmentally Conscious Products and Services, and Conduct Our Business Operations in an Environmentally Conscious Manner:

- ① We understand the importance of internal company systems and related details in maintaining third-party certification of our ISO environmental management systems, and we will observe relevant internal company rules.
- ② We will positively engage in the minimization of resource use, reduction in the size and weight of products, use of recycled materials, and the development of products and services that contribute to energy-saving, energy-creating and long life of products.
- ③ We will work to compile information related to harmful substances that might damage the environment or human health, and will not, as a matter of principle, make use of these harmful substances in our products, services and business activities.
- ④ We will ensure proper use and control of chemical substances in our business activities, including research, development, and manufacturing, at levels meeting or exceeding those stipulated by laws and regulations.
- ⑤ We will, as a matter of policy, design recycling-conscious products with structures that are detachable and decomposable and will use recyclable materials wherever possible.
- ⑥ As to the resources needed for business activities (equipments, raw materials, subsidiary materials, tools, etc.) , to the extent possible, we will work to conduct our business in such a way as to select and purchase such resources that have the least adverse effect on the global environment, the local residents and employees.
- ⑦ We realize that waste material is a valuable resource, and we will actively take part in maximizing the 3Rs (reduce, reuse, recycle) and minimizing the amount of final waste disposal.

* For more information: http://sharp-world.com/corporate/eco/csr_report/index.html

Corporate Vision: Eco-Positive Company

Sharp aims to be an “Eco-Positive Company,” a company that works with all stakeholders in creating solutions that have significantly more positive impact on the environment than negative impact caused by company operations.

To this end, Sharp will use the four aspects of its Eco-Positive Strategy to carry out advanced environmental efforts including spreading the use of solar power, improving the environmental performance of its products and devices, making plants more environmentally conscious, and developing one-of-a-kind environmental technologies.



■ The Four Aspects of the Eco-Positive Strategy



EP = Eco-Positive

- Eco-Positive Technologies**
Generate new business through one-of-a-kind environmental technologies
- Eco-Positive Products**
Expand contributions to protecting the environment through products and services
- Eco-Positive Operations**
Reduce environmental impacts in product engineering and manufacturing
- Eco-Positive Relationships**
Enhance corporate value through involvement with the community

Developing Devices with High Environmental Performance

Developing Green Devices and Super Green Devices

Sharp calls its environmentally conscious devices Green Devices (GD). To define guidelines for development and design based on seven concepts, Sharp established the GD Guidelines, which it began applying at all device design departments in fiscal 2004. The device development process starts with the planning stage, in which Sharp uses the GD Standard Sheet, which was formulated based on the GD Guidelines, to set specific objectives. In the trial manufacture and mass production stages, Sharp determines how well the actual device has met these objectives, with those achieving the standards being certified as GD. In fiscal 2005, Sharp began certifying devices from among GD with the highest possible levels of environmental performance as Super Green Devices (SGD). GD and SGD have been accounting for an increasing share of Sharp's net sales with each year.

Green Device Concepts

Energy Efficiency	Devices with superior energy efficiency and that consume less energy Reduce power consumption during operation and in standby mode.
Resource Conservation	Devices designed to conserve resources Reduce device weight or volume.
Recyclability	Devices designed for recycling Use standard plastic and/or design devices that are easy to disassemble.
Safe Use and Disposal	Devices that can be used and disposed of safely Control usage of chemical substances contained in parts and materials.
Long Life	Devices that make products last longer Extend the life of the product with exchangeable parts and consumables (target: LCD devices).
Packaging	Devices that use packaging with enhanced environmental consciousness Reduce packaging.
Information Disclosure	Devices that give environmental information Provide information on chemical substances in devices.

Super Green Devices Example

High-Output, High-Color-Rendering*¹ LED Lighting Devices

Industry-leading 91 lm/W luminous efficacy*² in the 25W-class achieved

GW5DMC30M04 is a high-output, high-color-rendering 25W-class LED lighting device that boasts an industry's highest luminous efficacy of 91 lm/W for light sources such as store spotlights. These 25W-class devices have achieved incredibly low energy consumption through the adoption of LED chips and phosphor, which both have excellent high-temperature properties. They provide a high 2 370-lm luminous flux and the industry's highest luminous efficacy of 91 lm/W. In addition, it achieved a high color rendering index (Ra)*³ of 83 by faithfully reproducing the colors of objects. Furthermore, the LED emitting area has been made circular to make designing lighting instruments easy.

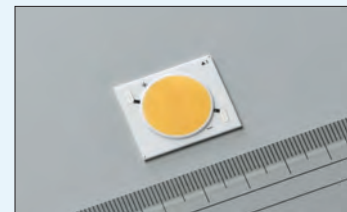

GW5DMC30M04

■ Main Features

- Industry-leading luminous efficacy of 91 lm/W achieved within the 25W-class
- Faithfully reproduces natural colors, with its high color rendering index (Ra) of 83

*¹ Color rendering describes how colors are perceived depending on differences in the illuminating light source. The closer to natural light, the higher the color rendering capability.

*² The brightness per watt. As of February 9, 2011, for LED lighting devices with an input power of 25 W, a color temperature of 3,000 K, and a color rendering index (Ra) 83 (based on Sharp survey).

*³ A numerical value expressing the level of color distortion compared to a reference light source. The closer the value to 100, the lower the color distortion.

Raising the Level of Environmental Performance in Factories

Making More Factories Super Green Factories

Sharp defines factories with a high level of environmental consciousness as Green Factories (GF). The basic policies and operational know-how for achieving GF status have been formulated in line with 10 concepts in the GF Guidelines, which Sharp has been applying at all production bases in Japan since fiscal 1999 and overseas since fiscal 2001.

With construction of the Kameyama Plant, in fiscal 2003 Sharp established assessment criteria for Super Green Factories (SGF)—factories with exceptionally high levels of environmental performance—and launched efforts to award in-house certification. The Kameyama Plant was the first plant to achieve this certification. Sharp started GF certification in fiscal 2004 and overseas as well, and Sharp has achieved its mid-term objective of having all Sharp plants in Japan and overseas certified for GF status and all 10 Sharp Corporation plants in Japan certified for SGF status by fiscal 2007.

In fiscal 2008, Sharp stepped up its SGF efforts with the start of the SGF II initiative at plants certified for SGF status.

Green Factory Concepts

Greenhouse gases	Minimize emission of greenhouse gases
Energy	Minimize energy consumption
Waste	Minimize discharge of waste
Resources	Minimize resource consumption
Chemical substances	Minimize risk of environmental pollution and accidents caused by chemical substances
Atmosphere, water, soil	Minimize environmental burden on the atmosphere, water, and soil
Harmony with nature	Endeavor to preserve nature both on and off site
Harmony with the community	Encourage harmony with the local community
Environmental consciousness	Foster high environmental awareness among employees
Information disclosure	Disclose information on the environment

Development of GREEN FRONT SAKAI

In order to become a company that contributes to the environment, Sharp has been developing its business on the two pillars of energy-saving LCDs and energy-creating solar cells. In order to further these efforts, Sharp commenced operations at a new LCD panel plant in October 2009, followed by a new solar cell plant in March 2010, in Sakai, Osaka prefecture. We hope to propel our business forward by having companies in other fields with advanced technology join us, to help us achieve the goal of creating a “green society” suitable to today’s environmentally conscious mindset.



GREEN FRONT



Overview of GREEN FRONT SAKAI

Location: 1-banchi, Takumi-cho, Sakai-ku, Sakai-shi, Osaka

Site area: 1.27 million m²
(approx. 28 times the size of Tokyo Dome)

LCD Panel Plant

Start of operations: October 2009

Mother glass size: 2,880 mm x 3,130 mm
(10th generation)

Mother glass input capacity: 72,000 substrates per month

Solar Cell Plants

■ Thin-film solar cell plant

Start of operations: March 2010

Production capacity: 160 MW per year
(first production development)

Glass substrate size: 1,000 mm x 1,400 mm

■ Single-crystal solar cell plant

Start of operations: March 2011

Production capacity: 200 MW per year
(first production development)

* The above information is current as of June 2011.

■ LCD Modules

<For industrial appliances>

Display size (cm) ["]	Model No.	Dot format H × V (dot)	Pixel pitch H × V (mm)	Active area H × V (mm)	Display colors	Luminance (cd/m ²) (TYP.)	Interface	Power consumption (W) (TYP.)	Outline dimensions*1 W × H × D (mm) (TYP.)	Weight (g) (MAX.)	Remarks
8.8 [3.5]	LQ035Q3DG03	320 × RGB × 240	0.2205 × 0.2205	70.56 × 52.92	16.77 M	450	CMOS 8-bit RGB	0.8	76.9 × 63.9 × 4.7	TYP. 42	Long-life LED backlight
12 [4.3]	☆LQ043T3DW03	480 × RGB × 272	0.198 × 0.198	95.04 × 53.86	16.77 M	400	CMOS 8-bit RGB	1.2	105.5 × 67.2 × 7.7	85	Advanced Super V, Long-life LED backlight
	LQ043T3DG01				260 k	400	CMOS 6-bit RGB	0.6	105.5 × 67.2 × 5.05	TYP. 65	
	LQ043T3DG02					480			105.5 × 67.2 × 3.95	TYP. 55	
14 [5.7]	LQ057V3LG11	640 × RGB × 480	0.18 × 0.18	115.2 × 86.4	260 k	350	1ch LVDS 6-bit RGB	2.3	144.0 × 104.6 × 12.3	190	Built-in LED backlight driver circuit
	★LQ057Q3DC03	320 × RGB × 240	0.36 × 0.36			500	CMOS 6-bit RGB	2.5	144.0 × 104.6 × 12.3	210	Long-life LED backlight, Built-in LED backlight driver circuit
18 [7.0]	LQ070Y3LW01	800 × RGB × 480	0.1905 × 0.1905	152.4 × 91.4	16.19 M	360	1ch LVDS 8-bit RGB	2.6	170.0 × 110.0 × 9.0	TYP. 175	Advanced Super V, Long-life LED backlight
	LQ070Y3DG3A					350	CMOS 6-bit + 2-bit FRC	2.0	163.2 × 104.0 × 3.9	150	
	LQ070Y3DG3B					280		2.0	163.2 × 104.0 × 7.1 (including touch panel)	185	With resistive touch panel
	LQ070Y3LG4A					350	LVDS 6-bit + 2-bit FRC	2.1	163.2 × 104.0 × 3.9	150	
21 [8.4]	☆LQ084S3LG03	800 × RGB × 600	0.213 × 0.213	170.4 × 127.8	16.77 M	330	1ch LVDS 8-bit RGB	4.1	199.5 × 154.0 × 11.6	320	Long-life LED backlight, Built-in LED backlight driver circuit
	LQ084V3DG02	640 × RGB × 480	0.267 × 0.267	170.88 × 128.16	260 k	400	CMOS 6-bit RGB	4.6	199.5 × 149.5 × 11.6	400	Long-life LED backlight
26 [10.4]	☆LQ104V1DG81/LG81	640 × RGB × 480	0.33 × 0.33	211.2 × 158.4	260 k	450	CMOS 6-bit RGB/ 1ch LVDS 6-bit RGB	5.6	246.5 × 179.4 × 12.5	TYP. 500	Strong LCD2, Long-life LED backlight, Built-in LED backlight driver circuit
31 [12.1]	LQ121S1LG81	800 × RGB × 600	0.3075 × 0.3075	246.0 × 184.5	260 k	450	LVDS 6-bit RGB	5.1	276.0 × 209.0 × 9.1	600	Long-life LED backlight, HV mode*2, Built-in LED backlight driver circuit
	☆LQ121S1LG84										Long-life LED backlight, DE mode*3, Built-in LED backlight driver circuit
38 [15.0]	LQ150X1LG91	1 024 × RGB × 768	0.297 × 0.297	304.1 × 228.1	16.19 M	350	LVDS 8-bit + 2-bit FRC	6.8	326.5 × 253.5 × 9.6	950	Long-life LED backlight, Built-in LED backlight driver circuit
48 [19.0]	LQ190E1LX51	1 280 × RGB × 1 024	0.294 × 0.294	376.32 × 301.056	16.77 M	1 000	2ch LVDS 8-bit RGB	75	404.2 × 330.0 × 34.0	2 600	Advanced Super V, Built-in LED backlight driver circuit
	★LQ190E1LW52					300		15.3	404.2 × 330.0 × 15.0	1 850	Advanced Super V, Long-life LED backlight
59 [23.1]	LQ231U1LW32	1 600 × RGB × 1 200	0.294 × 0.294	470.4 × 352.8	16.77 M	500	LDI 8-bit RGB	65.5	530.0 × 431.5 × 23.9	4 500	Advanced Super V, Built-in LED backlight driver circuit

All products listed on this page are LED backlight models.

*1 Protrusions such as positioning bosses are not included.

*2 Hsync/Vsync mode

*3 Data enable mode

(Note) Please note that the specifications are subject to change without prior notice for product improvement.

Notice

In the absence of confirmation by device specification sheets, SHARP takes no responsibility for any defects that may occur in equipment using any SHARP devices shown in catalogs, data books, etc. For details, please inquire with SHARP. Contact SHARP in order to obtain the latest device specification sheets before using any SHARP device.



<For large-size product applications>

Display size (cm) ["]	Model No.	Number of pixels*1	Dot format H × V (dot)	Active area H × V (mm)	Display colors	Luminance (cd/m ²) (TYP.)	Interface	Outline dimensions*2 W × H × D (mm) (TYP.)	Backlight	Remarks
80.0 [31.5]	★LQ315D1LG91	8 294 400	3 840 × RGB × 2 160	697.92 × 392.58	(1.06B) (10-bit)	(450)	(8ch-LVDS)*3 (10-bit digital)	(733 × 428 × 33)*4	Direct-lit LED (built-in driver)	Super-high resolution and low power consumption (MAX. 150 W) achieved by using IGZO*5 LCD Wide viewing angle: L/R 176°/ U/D 176°, Response time [G to G]: 8 ms (Ave.)
152.5 [60]	LK601R3LA19	8 294 400	3 840 × RGB × 2 160	1 330.56 × 748.44	1.06B (8-bit + 2-bit FRC)	450	8ch-LVDS*3 (10-bit digital)	1 380.0 × 790.0 × 106.6	Direct-lit LED (built-in driver)	Ultraviolet-induced Multi-domain Vertical Alignment LCD, High color purity (78% of NTSC), Wide viewing angle: L/R 176°/ U/D 176°, High contrast: 4 000:1, High-speed response [G to G]: 6 ms (Ave.)
	★LK600D3LB14	2 073 600	1 920 × RGB × 1 080	1 329.12 × 747.63		2 000	2ch-LVDS*3 (10-bit digital)			Ultraviolet-induced Multi-domain Vertical Alignment LCD, Wide viewing angle: L/R 176°/ U/D 176°, High contrast: 5 000:1 or higher, High-speed response [G to G]: 6 ms (Ave.)
207.2 [81.6]	LK816D3LA19	2 073 600	1 080 × 1 920 × RGB	1 015.74 × 1 805.76	1.06B (8-bit + 2-bit FRC)	1 200	2ch-LVDS*3 (10-bit digital)	1 094.0 × 1 879.0 × 81.9	Built-in CCFL	Portrait setting, Advanced Super V, Wide viewing angle: L/R 176°/ U/D 176°, High contrast: 2 000:1, High-speed response [G to G]: 6 ms (Ave.)

*1 Pixel means a set of each RGB dot.

*2 Excluding FPC for connection and other protruding parts.

*3 LVDS: Low Voltage Differential Signaling

*4 Excluding the LED driver.







*5 IGZO: an oxide semiconductor consisting of In (Indium), Ga (Gallium), and Zn (Zinc).

(Note) Please note that the specifications are subject to change without prior notice for product improvement.

Notice

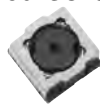
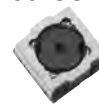
In the absence of confirmation by device specification sheets, SHARP takes no responsibility for any defects that may occur in equipment using any SHARP devices shown in catalogs, data books, etc. For details, please inquire with SHARP. Contact SHARP in order to obtain the latest device specification sheets before using any SHARP device.

■ CMOS Camera Modules Road Map

Image format	2009	2010	2011	2012
12M (HXGA)				<div style="display: flex; justify-content: space-around;"> <div style="border: 1px solid black; padding: 5px; text-align: center;"> <p>☆RJ63YC100</p>  <p>1/3.2 type 0.66 cc</p> <p>Built-in optical image stabilization and auto focus functions 11.0 x 11.0 x 5.47</p> </div> <div style="border: 1px solid black; padding: 5px; text-align: center;"> <p>☆RJ63YC200</p>  <p>1/3.2 type 0.40 cc</p> <p>Built-in auto focus function 8.5 x 8.5 x 5.47</p> </div> </div>
8M (QUXGA)			<div style="border: 1px solid black; padding: 5px; text-align: center;"> <p>RJ63VC200</p>  <p>1/3.2 type 0.42 cc</p> <p>Built-in auto focus function 8.52 x 8.52 x 5.8</p> </div>	
5M (QSXGA)	<div style="border: 1px solid black; padding: 5px; text-align: center;"> <p>RJ64SC100</p>  <p>1/4 type 0.36 cc</p> <p>Built-in auto focus function 8.5 x 8.5 x 5.0</p> </div>	<div style="border: 1px solid black; padding: 5px; text-align: center;"> <p>RJ64SC200</p>  <p>1/4 type 0.36 cc</p> <p>Built-in auto focus function 8.5 x 8.5 x 5.0</p> </div>		
3M (QXGA)		<div style="border: 1px solid black; padding: 5px; text-align: center;"> <p>RJ64PC800</p>  <p>1/4 type 0.37 cc</p> <p>Built-in auto focus function 8.5 x 8.5 x 5.1</p> </div>		
VGA			<div style="display: flex; justify-content: space-around;"> <div style="border: 1px solid black; padding: 5px; text-align: center;"> <p>RJ6CBA100</p>  <p>1/13 type 0.03 cc</p> <p>3.71 x 3.35 x 2.3</p> </div> <div style="border: 1px solid black; padding: 5px; text-align: center;"> <p>RJ6CBA200</p>  <p>1/13 type 0.02 cc</p> <p>3.50 x 3.05 x 2.3</p> </div> </div>	

Model No.

Optical format & volume

Outline dimensions (D x W x H) TYP. (mm)

Notice

In the absence of confirmation by device specification sheets, SHARP takes no responsibility for any defects that may occur in equipment using any SHARP devices shown in catalogs, data books, etc.

Except where specially indicated, models listed on this page comply with the RoHS Directive*. For details, please contact SHARP. *RoHS Directive: Prohibits use of lead, cadmium, hexavalent chromium, mercury and specific brominated flame retardants (PBBs and PBDEs), with certain exceptions.

Contact SHARP in order to obtain the latest device specification sheets before using any SHARP device.

CMOS Camera Modules

Module configuration : CMOS image sensor, CDS/AGC/10-bit ADC, timing generator, DSP, lens
 Color filter : R, G, B primary color mosaic filters
 Operating temperature : -20 to 60°C

Optical format	Image format	Optical function	Model No.	Features	Output pixels (H x V) MAX.	Lens			Output signal	Supply voltage*2 (V) TYP.	Power consumption*3 (mW) TYP.	Package*1	
						F No.	Config-uration	Horizontal viewing angle (°)					
1/3.2 type	HXGA	OIS*4 function, auto focus function	☆RJ63YC100	<ul style="list-style-type: none"> • HXGA to QVGA • 19 fps at HXGA/60 fps at 1 080p • 12.5x electronic zoom at QVGA size (MAX.) • Image inversion function (top and bottom / right and left) 	4 016 x 3 016	F2.5	5 pcs.	61	RAW (Mipi)	2.8/1.8/1.2 (I/O: 1.8 or 2.8)	270 (at 18.6 fps)	FPC type	
			☆RJ63YC200										
1/4 type	QUXGA	Auto focus function	RJ63VC200	<ul style="list-style-type: none"> • QUXGA to SubQCIF • 15 fps at QUXGA/60 fps at 720p • 10.5x electronic zoom at QVGA size (MAX.) • Image inversion function (right and left) 	3 280 x 2 464	F2.4	5 pcs.	59	RAW (Mipi)	2.8/1.8 (I/O: 1.8 or 2.8)	136 (at 7.5 fps)		
			RJ64SC100	<ul style="list-style-type: none"> • QSXGA to SubQCIF • 5 fps at QSXGA/30 fps at VGA • 8x electronic zoom at QVGA size (MAX.) • Image inversion function (right and left) 	2 592 x 1 944						4 pcs.		54
	RJ64SC200		<ul style="list-style-type: none"> • QSXGA to SubQCIF • 15 fps at QSXGA/30 fps at 720p • 8x electronic zoom at QVGA size (MAX.) • Image inversion function (right and left) 	283 (at 4.5 fps)									
1/13 type	VGA	—	RJ64PC800	<ul style="list-style-type: none"> • QXGA to SubQCIF • 7.5 fps at QXGA/30 fps at XGA • 6.4x electronic zoom at QVGA size (MAX.) • Image inversion function (right and left) 	2 048 x 1 536	F2.8	3 pcs.	54	UYVY (Parallel)	2.8/1.8 (I/O: 1.8 or 2.8)	190 (at 7.5 fps)		
			RJ6CBA200	<ul style="list-style-type: none"> • VGA to SubQCIF • 30 fps at VGA 	640 x 480						1 pcs.	53	77 (at 30 fps)
			RJ6CBA100	<ul style="list-style-type: none"> • 2x electronic zoom at QVGA size (MAX.) • Image inversion function (right and left) 									21 (at 30 fps)

*1 Contact a SHARP sales office regarding FPC type package.
 *2 Additional supply voltage of 3.0 V is necessary for RJ64SC100/200 with a built-in AF driver.
 *3 Actuator power consumption is not included.
 *4 OIS: Optical image stabilization

Outline Dimensions

Model No.	Outline dimensions (D x W x H) TYP. (mm)	Package*1
☆RJ63YC100	11.0 x 11.0 x 5.47	FPC type
☆RJ63YC200	8.5 x 8.5 x 5.47	
RJ63VC200	8.52 x 8.52 x 5.8	
RJ64SC100	8.5 x 8.5 x 5.0	
RJ64SC200		
RJ64PC800	8.5 x 8.5 x 5.1	
RJ6CBA200	3.50 x 3.05 x 2.3	25WL-CSP
RJ6CBA100	3.71 x 3.35 x 2.3	21WL-CSP

*1 Contact a SHARP sales office regarding FPC type package.

System Configuration Example

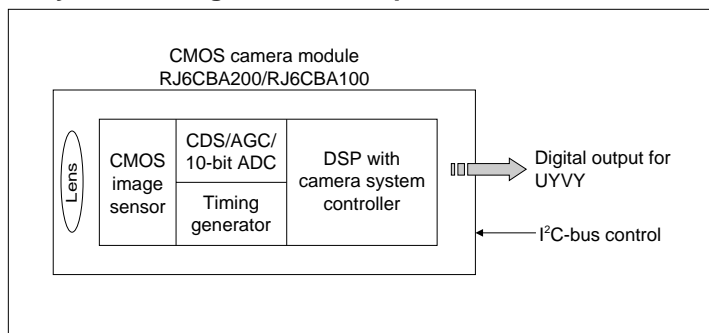

Notice

In the absence of confirmation by device specification sheets, SHARP takes no responsibility for any defects that may occur in equipment using any SHARP devices shown in catalogs, data books, etc. Except where specially indicated, models listed on this page comply with the RoHS Directive*. For details, please contact SHARP. *RoHS Directive: Prohibits use of lead, cadmium, hexavalent chromium, mercury and specific brominated flame retardants (PBBs and PBDEs), with certain exceptions. Contact SHARP in order to obtain the latest device specification sheets before using any SHARP device.



■ Road Map for High-resolution CCDs for Digital Cameras

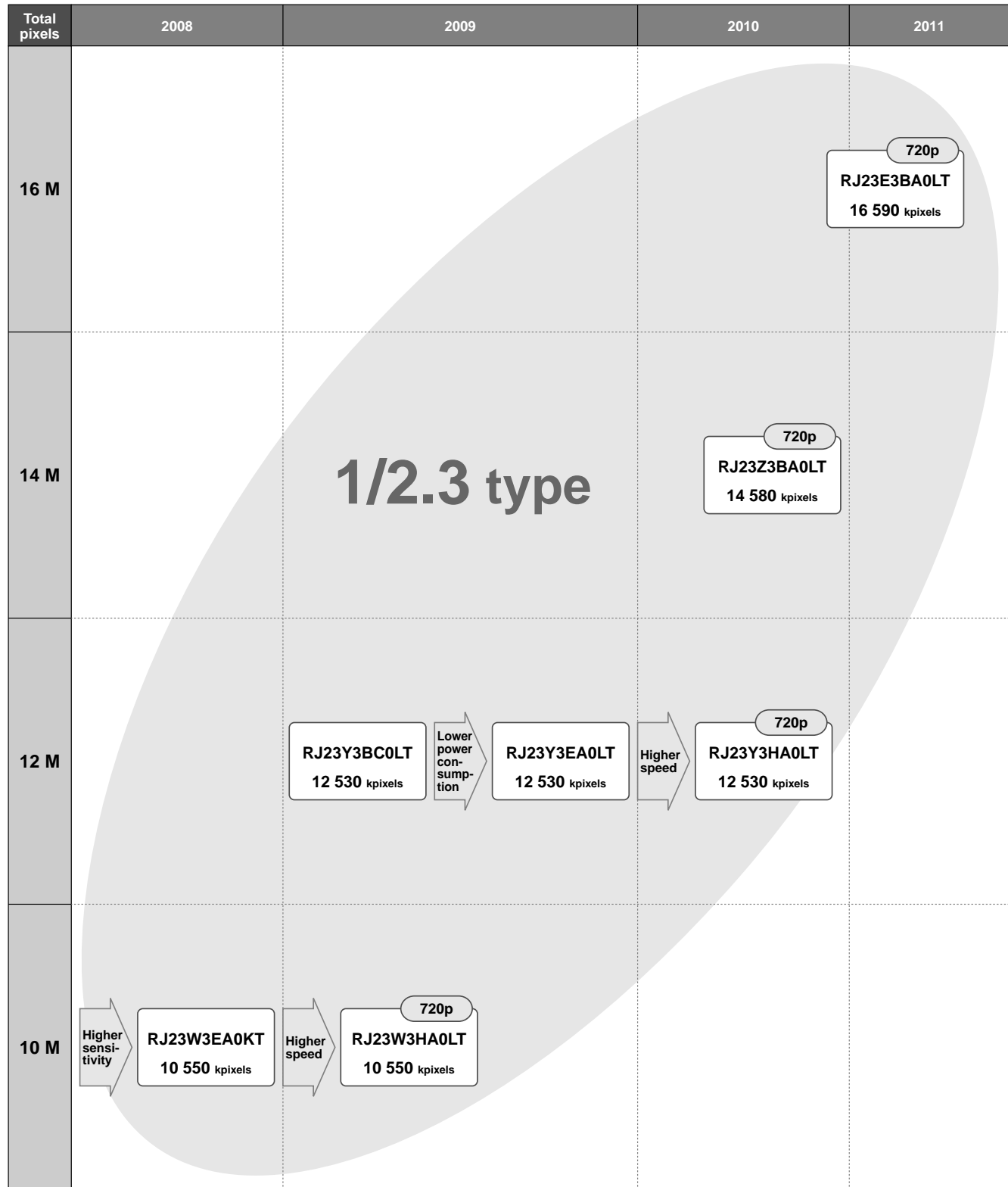

Notice

In the absence of confirmation by device specification sheets, SHARP takes no responsibility for any defects that may occur in equipment using any SHARP devices shown in catalogs, data books, etc. Except where specially indicated, models listed on this page comply with the RoHS Directive*. For details, please contact SHARP. *RoHS Directive: Prohibits use of lead, cadmium, hexavalent chromium, mercury and specific brominated flame retardants (PBBs and PBDEs), with certain exceptions. Contact SHARP in order to obtain the latest device specification sheets before using any SHARP device.

■ High-resolution CCDs

Optical format	Total pixels	Color filter	Model No.	Movie function	Resolution	Pixel size H x V (μm ²)	Sensitivity (mV) TYP.	Smear ratio (dB) TYP.	Package
					Image pixels (H x V)				
1/2.3 type	10 550 k	R,G,B primary color mosaic filters	RJ23W3EA0KT	VGA 30 fps	3 704 x 2 784	1.68 x 1.68	105	-87	N-LCC040-S433A
			RJ23W3HA0LT	720p 30 fps					
	12 530 k		RJ23Y3BC0LT	VGA 30 fps	4 040 x 3 032	1.55 x 1.55	105	-86	N-LCC040-R350
			RJ23Y3EA0LT						
			RJ23Y3HA0LT	720p 30 fps					
			RJ23Z3BA0LT	720p 30 fps					
14 580 k	RJ23E3BA0LT	720p 30 fps	4 648 x 3 488	1.34 x 1.34	105	-86			

■ 1/3-type CCDs

Total pixels	Standard		Model No.	Resolution		Pixel size H x V (μm ²)	Sensitivity (mV) TYP.	Smear ratio (dB) TYP.	Package		
				Horizontal TV lines	Image pixels (H x V)						
270 k	Color	NTSC	RJ2311DB0PB*1	330	512 x 492	9.6 x 7.5	3 200	-135	P-DIP016-0450		
			RJ2315DB0PB*1				2 900				
320 k		PAL	RJ2321DB0PB*1		512 x 582	9.6 x 6.34	3 200	-135			
			RJ2325DB0PB*1				2 900				
410 k		Color	NTSC		RJ2351CA0PB*1	480	768 x 494	6.4 x 7.5		2 000	-120
					RJ2355CA0PB*1					1 800	
470 k	PAL		RJ2361CA0PB*1	752 x 582	6.53 x 6.39		2 000	-120			
			RJ2365CA0PB*1				1 800		-130		
520 k	Color		NTSC	☆RJ2331AA0PB*1	650		976 x 494	5.0 x 7.4		2 000	-120
				☆RJ3331AA0PB*2					1 500	-120	
610 k		PAL	☆RJ2341AA0PB*1	976 x 582		5.0 x 6.3	2 000	-120			
			☆RJ3341AA0PB*2				1 500		-120		

*1 Suitable for intense light exposure.

*2 Progressive scan CCD, suitable for intense light exposure.

■ 1/3.8-type CCD

Total pixels	Standard		Model No.	Resolution		Pixel size H x V (μm ²)	Sensitivity TYP. (mV)	Smear ratio TYP. (dB)	Package
				Horizontal TV lines	Image pixels (H x V)				
290 k	Color	NTSC	RJ2411CA0PB*	330	532 x 512	7.2 x 5.6	1 200	-120	P-DIP014-0400A

* Suitable for intense light exposure.

■ 1/4-type CCDs

Total pixels	Standard		Model No.	Resolution		Pixel size H x V (μm ²)	Sensitivity TYP. (mV)	Smear ratio TYP. (dB)	Package
				Horizontal TV lines	Image pixels (H x V)				
270 k	Color	NTSC	RJ2411EA0PB*	330	512 x 492	7.2 x 5.6	1 200	-130	P-DIP014-0400A
			RJ2411EB0PB				1 800		
			RJ2411FA0PB*						
320 k		PAL	RJ2421EB0PB		512 x 582	7.2 x 4.73	1 100	-130	
			RJ2421FA0PB*				1 650		
410 k		Color	NTSC		RJ2451CA0PB*	480	768 x 494	4.9 x 5.6	
	RJ2455CA0PB*								
470 k	PAL		RJ2461CA0PB*	752 x 582	5.0 x 4.77		900	-114	
			RJ2465CA0PB*						

* Suitable for intense light exposure.

Notice

In the absence of confirmation by device specification sheets, SHARP takes no responsibility for any defects that may occur in equipment using any SHARP devices shown in catalogs, data books, etc.
 Except where specially indicated, models listed on this page comply with the RoHS Directive*. For details, please contact SHARP.
 *RoHS Directive: Prohibits use of lead, cadmium, hexavalent chromium, mercury and specific brominated flame retardants (PBBs and PBDEs), with certain exceptions.
 Contact SHARP in order to obtain the latest device specification sheets before using any SHARP device.

■ CCD Peripheral ICs/LSIs

Description	Model No.	Features	Package
V driver	LR366851	Vertical pulse driver for CCDs, 2-level output x 2, 3-level output x 4, 2-level output circuit for electronic shutter	P-SSOP024-0275
CDS/PGA/ADC	LR36B03A	Low power consumption [81 mW (TYP.)], high-speed S/H circuit, high-gain PGA circuit, 12-bit ADC (25 MHz), mechanical iris control function, 12-bit digital output	P-HQFN036-0606
V driver + CDS/PGA/ADC + DSP	LR38653	For 270-k/320-k/410-k/ 470-kpixel CCDs <V driver> Vertical pulse driver for CCDs, 2-level output x 2, 3-level output x 2, 2-level output circuit for electronic shutter <CDS/PGA/ADC> 25 MHz, high-speed S/H circuit, high-gain PGA circuit, 12-bit ADC <DSP> 10-bit DAC, synchronous signal generation circuit, CCD drive timing generator, AE control function, AWB control function, lens shading correction function, auto white blemish compensation function, mirror image function, YUV digital output, NTSC/PAL analog output	P-LFBGA171-0811
	LR38654	For 270-k/290-k/320-k/410-k/ 470-kpixel CCDs <V driver> Vertical pulse driver for CCDs, 2-level output x 2, 3-level output x 2, 2-level output circuit for electronic shutter <CDS/PGA/ADC> 25 MHz, high-speed S/H circuit, high-gain PGA circuit, 12-bit ADC <DSP> 10-bit DAC, synchronous signal generation circuit, CCD drive timing generator, AE control function, AWB control function, lens shading correction function, auto white blemish compensation function, mirror image function, electronic optical axis adjustment function*1, YUV digital output, NTSC/PAL analog output	P-LFBGA171-0811
CDS/PGA/ADC + DSP	LR36B14	For 270-k/320-k/410-k/ 470-kpixel CCDs <CDS/PGA/ADC> High-speed S/H circuit, high-gain PGA circuit, 12-bit ADC <DSP> 75-ohm video amplifier, mechanical iris control function, 10-bit DAC, synchronous signal generation circuit, CCD drive timing generator, AE control function, AWB control function, LED light control function, gamma transition function, lens shading correction function, auto white blemish compensation function, mirror image function, NTSC/PAL analog output	P-HQFN064-0909
	☆LR36B15	<CDS/PGA/ADC> High-speed S/H circuit, high-gain PGA circuit, 12-bit ADC <DSP> 75-ohm video amplifier, mechanical iris control function, 10-bit DAC, synchronous signal generation circuit, CCD drive timing generator, AE control function, AWB control function, lens shading correction function, auto white blemish compensation function, mirror image function, NTSC/PAL analog output	
DSP	LR38627	10-bit DAC, synchronous signal generation circuit, CCD drive timing generator, AE control function, AWB control function, lens shading correction function, auto white blemish compensation function, mirror image function, YUV digital output, NTSC/PAL analog output	P-TQFP128-1414
	LR38690A	For 270-k/320-k/410-k/ 470-kpixel CCDs 10-bit DAC, synchronous signal generation circuit, CCD drive timing generator, AE control function, AWB control function, lens shading correction function, auto white blemish compensation function, mirror image function, mechanical iris control function, privacy masking function, Day/Night control function, color rolling suppression function, high resolution function, NTSC/PAL analog output, Y/C analog output, UYVY digital output (ITU-R BT656 compatible)*2	P-LQFP100-1414
Power supply IC for CCDs and peripheral ICs/LSIs	IR3M59U	For 270-k/320-kpixel CCDs Input voltage range: 4.5 to 16 V, PWM control + charge pump system, output voltage: three outputs (15 V/12 V, -8 V/-5 V, 3.3 V), power sequencing circuit, overcurrent protection circuit	P-VQFN032-0505
	IR3M63U	For 270-k/290-k/320-k/410-k/ 470-kpixel CCDs Input voltage range: 4.5 to 10 V, PWM control + charge pump system, output voltage: four outputs (15 V, -8 V, 3.3 V, 1.8 V), power sequencing circuit, overcurrent protection circuit	

*1 Support for only 290-kpixel CCD.

*2 Support for only 410-k/470-kpixel CCDs.

Notice

In the absence of confirmation by device specification sheets, SHARP takes no responsibility for any defects that may occur in equipment using any SHARP devices shown in catalogs, data books, etc. Except where specially indicated, models listed on this page comply with the RoHS Directive*. For details, please contact SHARP. *RoHS Directive: Prohibits use of lead, cadmium, hexavalent chromium, mercury and specific brominated flame retardants (PBBs and PBDEs), with certain exceptions. Contact SHARP in order to obtain the latest device specification sheets before using any SHARP device.



● System Configuration Examples

<Color Security Camera System with Two-chip Configuration [Low Power Consumption Type]>

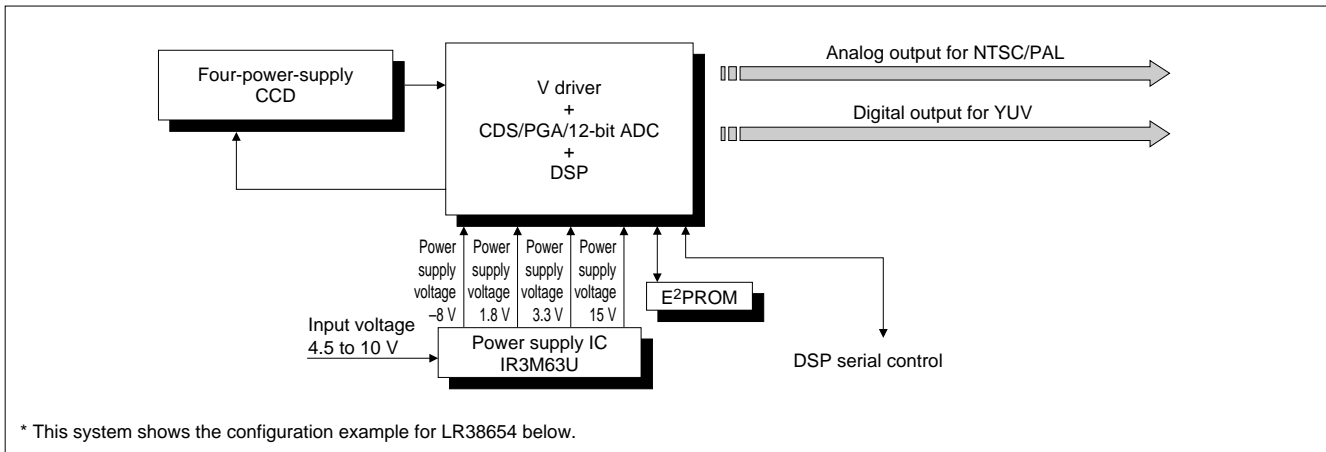

Four-power-supply CCDs and peripheral IC/LSIs

CCD			V driver + CDS/PGA/ADC + DSP	Power supply IC
1/3 type	270 kpixels	RJ2311DB0PB	LR38653/LR38654	—
		RJ2315DB0PB		
	320 kpixels	RJ2321DB0PB		
		RJ2325DB0PB		
	410 kpixels	RJ2351CA0PB		
		RJ2355CA0PB		
470 kpixels	RJ2361CA0PB			
	RJ2365CA0PB			
1/3.8 type	290 kpixels	RJ2411CA0PB	LR38654	IR3M63U
1/4 type	270 kpixels	RJ2411EA0PB	LR38653/LR38654	
		RJ2411EB0PB		
		RJ2411FA0PB		
	320 kpixels	RJ2421EB0PB		
		RJ2421FA0PB		
	410 kpixels	RJ2451CA0PB		
RJ2455CA0PB				
470 kpixels	RJ2461CA0PB			
	RJ2465CA0PB			

CMOS Image Sensors/
CCDs

Notice

In the absence of confirmation by device specification sheets, SHARP takes no responsibility for any defects that may occur in equipment using any SHARP devices shown in catalogs, data books, etc. Except where specially indicated, models listed on this page comply with the RoHS Directive*. For details, please contact SHARP. *RoHS Directive: Prohibits use of lead, cadmium, hexavalent chromium, mercury and specific brominated flame retardants (PBBs and PBDEs), with certain exceptions. Contact SHARP in order to obtain the latest device specification sheets before using any SHARP device.

<Color Security Camera System with Three-chip Configuration>

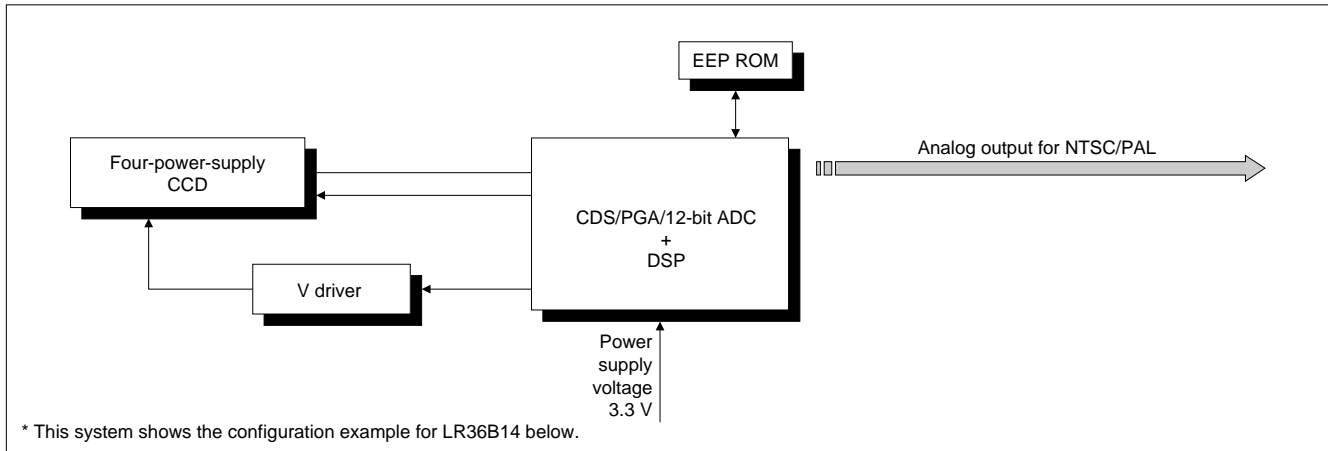

Four-power-supply CCDs and peripheral ICs/LSIs

CCD		CDS/PGA/ADC + DSP	
1/3 type	270 kpixels	RJ2311DB0PB	LR36B14/☆LR36B15
		RJ2315DB0PB	
	320 kpixels	RJ2321DB0PB	
		RJ2325DB0PB	
	410 kpixels	RJ2351CA0PB	
		RJ2355CA0PB	
	470 kpixels	RJ2361CA0PB	
		RJ2365CA0PB	
1/4 type	270 kpixels	RJ2411EA0PB	
		RJ2411EB0PB	
		RJ2411FA0PB	
	320 kpixels	RJ2421EB0PB	
		RJ2421FA0PB	
	410 kpixels	RJ2451CA0PB	
		RJ2455CA0PB	
	470 kpixels	RJ2461CA0PB	
		RJ2465CA0PB	

Notice

In the absence of confirmation by device specification sheets, SHARP takes no responsibility for any defects that may occur in equipment using any SHARP devices shown in catalogs, data books, etc.
 Except where specially indicated, models listed on this page comply with the RoHS Directive*. For details, please contact SHARP.
 *RoHS Directive: Prohibits use of lead, cadmium, hexavalent chromium, mercury and specific brominated flame retardants (PBBs and PBDEs), with certain exceptions.
 Contact SHARP in order to obtain the latest device specification sheets before using any SHARP device.



<Color Security Camera System with Four-chip Configuration (I)>

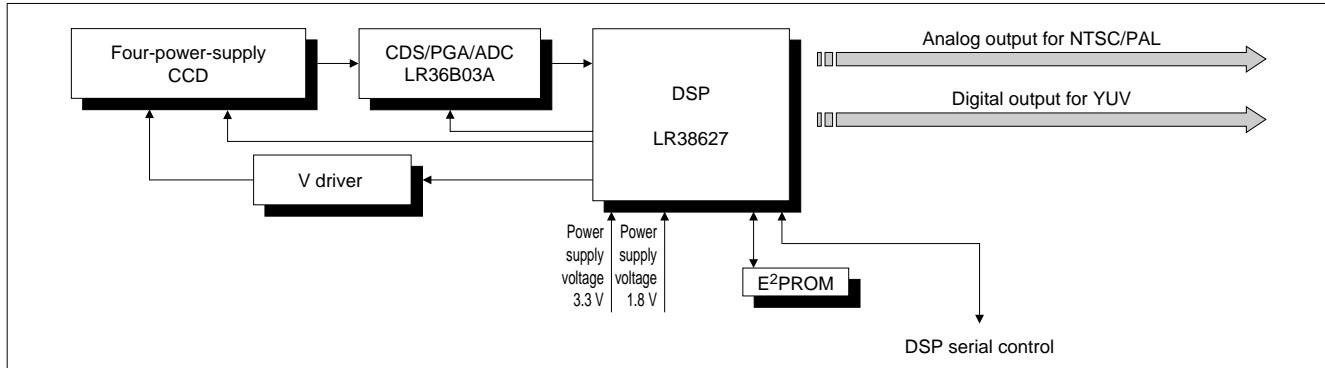

Four-power-supply CCDs and peripheral ICs/LSIs

CCD		CDS/PGA/ADC	DSP	
1/3 type	270 kpixels	RJ2311DB0PB	LR36B03A	
		RJ2315DB0PB		
	320 kpixels	RJ2321DB0PB		
		RJ2325DB0PB		
	410 kpixels	RJ2351CA0PB		
		RJ2355CA0PB		
	470 kpixels	RJ2361CA0PB		LR38627
		RJ2365CA0PB		
1/4 type	270 kpixels	RJ2411EA0PB		
		RJ2411EB0PB		
		RJ2411FA0PB		
	320 kpixels	RJ2421EB0PB		
		RJ2421FA0PB		
	410 kpixels	RJ2451CA0PB		
		RJ2455CA0PB		
	470 kpixels	RJ2461CA0PB		
		RJ2465CA0PB		

Notice

In the absence of confirmation by device specification sheets, SHARP takes no responsibility for any defects that may occur in equipment using any SHARP devices shown in catalogs, data books, etc. Except where specially indicated, models listed on this page comply with the RoHS Directive*. For details, please contact SHARP. *RoHS Directive: Prohibits use of lead, cadmium, hexavalent chromium, mercury and specific brominated flame retardants (PBBs and PBDEs), with certain exceptions. Contact SHARP in order to obtain the latest device specification sheets before using any SHARP device.



<Color Security Camera System with Four-chip Configuration (II)>

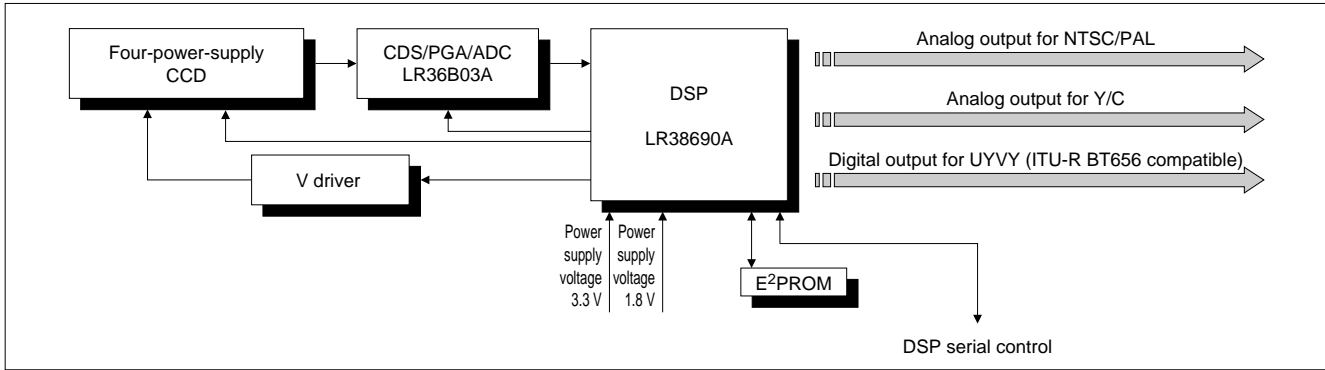

Four-power-supply CCDs and peripheral ICs/LSIs

CCD		CDS/PGA/ADC	DSP
1/3 type	270 kpixels	RJ2311DB0PB	LR38690A
		RJ2315DB0PB	
	320 kpixels	RJ2321DB0PB	
		RJ2325DB0PB	
	410 kpixels	RJ2351CA0PB	
		RJ2355CA0PB	
	470 kpixels	RJ2361CA0PB	
		RJ2365CA0PB	
1/4 type	270 kpixels	RJ2411EA0PB	LR36B03A
		RJ2411EB0PB	
		RJ2411FA0PB	
	320 kpixels	RJ2421EB0PB	
		RJ2421FA0PB	
	410 kpixels	RJ2451CA0PB	
		RJ2455CA0PB	
	470 kpixels	RJ2461CA0PB	
		RJ2465CA0PB	

Notice

In the absence of confirmation by device specification sheets, SHARP takes no responsibility for any defects that may occur in equipment using any SHARP devices shown in catalogs, data books, etc.
 Except where specially indicated, models listed on this page comply with the RoHS Directive*. For details, please contact SHARP.
 *RoHS Directive: Prohibits use of lead, cadmium, hexavalent chromium, mercury and specific brominated flame retardants (PBBs and PBDEs), with certain exceptions.
 Contact SHARP in order to obtain the latest device specification sheets before using any SHARP device.



■ For Notebook PCs, PC Monitors and LCD TVs

● TFT-LCD Drivers

Drive function		Model No.	Gray scale	No. of LCD drive outputs	Display voltage (V) MAX.	Clock frequency (MHz) MAX.	Supply voltage (V)	Description	Package
Source driver	Dot inversion drive	LH16DD	256 levels	630/642/684/720	16.5	250	2.7 to 3.6	Low EMI*1 driver using mini-LVDS interface, R-DAC system	SOF
		LH16DK				380			
		LH16DH	804/840/912/960	330					
		LH16DE	1 024 levels	630/642/684/720		250			
Gate driver		LH163Y	—	202/242/258/262/272	20 to 45	200	2.1 to 4.2	Output signal masking function, enables construction of module without printed circuit board	

*1 EMI: Electro-Magnetic Interference

● TFT-LCD Controller

Model No.	Image size	Input interface	Output interface	Functions	Clock frequency (MHz) MAX.	Supply voltage (V)			Package
						Core	Digital	Analog	
LR388H3	1 366 x 768 1 920 x 1 080	LVDS 4ch 8/10 bits	mini-LVDS 4ch 8/10 bits	<ul style="list-style-type: none"> Improves response speed of LCD image by original Quick Shoot technology (with a built-in frame memory) Register control by external EEPROM (SPI) and I²C I/F Control gamma correction IC (SPI) 	170	0.9 to 1.1	3.0 to 3.6	2.3 to 2.7	TFBGA421-1919

● LED Backlight Controller

Model No.	LED type	Video input interface	Video output interface	LED output interface	Functions	Frame rate (fps)	Supply voltage (V)			Package
							Core	LVDS	IO	
LR388H0	White LEDs	LVDS 2ch 8/10 bits	LVDS 2ch 8/10 bits	SPI	<ul style="list-style-type: none"> LED backlight controller using area active technology (MAX. 32 x 16 areas) Support for 1 920 x 1 080 / 1 366 x 768 LCD panel Support for wide variety of backlight systems (Direct-type, edge-type, even/odd numbered area division, etc.) Register control by external EEPROM (SPI) and I²C I/F 	48/50/60	1.1 to 1.3	2.3 to 2.7/ 3.0 to 3.6	3.0 to 3.6	TFBGA164-1212

Notice

In the absence of confirmation by device specification sheets, SHARP takes no responsibility for any defects that may occur in equipment using any SHARP devices shown in catalogs, data books, etc. Except where specially indicated, models listed on this page comply with the RoHS Directive*. For details, please contact SHARP. *RoHS Directive: Prohibits use of lead, cadmium, hexavalent chromium, mercury and specific brominated flame retardants (PBBs and PBDEs), with certain exceptions. Contact SHARP in order to obtain the latest device specification sheets before using any SHARP device.



■ For Mobile Devices

● TFT-LCD Controllers

Model No.	LCD interface (pixel) MAX.	Display colors MAX.	Display RAM capacity (bit)	Function	CPU interface	Supply voltage (V)		Package
						Core	Host I/F	
LR388J4	600 x 1 024	16 770 k colors	44 M (Flexibly meets the requirement depending on the panel size)	<ul style="list-style-type: none"> Built-in 2D-3D image conversion function MDDI*1 1.1/1.2 type2-compliant MIP1*2-compliant Built-in IrSimple™ and IrDA communications functions Main/sub LCD controller Graphic processing Built-in SDHC interface Built-in HDMI 1 080p/24 Hz, 1 080i/60 Hz output interface 	MDDI*1 for MSM series/80-family (8/16/18-bit parallel) MIP1*2 DSI type4	1.08 to 1.32	1.65 to 3.3	P-WFBGA385-0909
LR388G9			32 M (Flexibly meets the requirement depending on the panel size)	<ul style="list-style-type: none"> MDDI*1 1.1/1.2 type2-compliant MIP1*2-compliant Built-in IrSimple™ and IrDA communications functions Main/sub LCD controller Graphic processing Built-in SDHC interface Built-in HDMI 1 080p/24 Hz, 1 080i/60 Hz output interface 				
LR388D8		480 x 864	16 M (Flexibly meets the requirement depending on the panel size)	<ul style="list-style-type: none"> MDDI*1-compliant Built-in IrSimple™ and IrDA communications functions Main/sub LCD controller Graphic processing Built-in SDHC interface 	MDDI*1 for MSM series/80-family (8/9/16/18-bit parallel)	1.65 to 1.95	P-WFBGA205-0808	
LR388D1	240 x 400	262 144 colors	240 x 400 x 18	<ul style="list-style-type: none"> MDDI*1-compliant Built-in IrSimple™ and IrDA communications functions Main/sub LCD controller Graphic processing 				P-VFBGA144-0808

*1 MDDI (Mobile Display Digital Interface): The serial interface standard developed by QUALCOMM

*2 MIP1: Mobile Industry Processor Interface

IrSimple™ is a trademark of Infrared Data Association.
QUALCOMM and MSM are trademarks of QUALCOMM Incorporated.

■ Power Supply ICs for TFT-LCDs

Model No.	No. of output circuits	Input voltage range (V)	Output voltage (V)	System	Switching frequency (Hz)	Switching transistor	Switching current (mA) [Built-in SW Tr]	Drive capacity (pF) [External SW Tr]	Package
IR3M58M/U	3	4.5 to 28	External setting	Step-up (MAX. 20 V)/step-down type PWM	70 k to 500 k	Built-in (for step-up type PWM)	400	1 000	P-QFP048-0707/ P-VQFN036-0505
				Step-down type PWM		External	–		
				Step-down, inverting type PWM		External	–		

Notice

In the absence of confirmation by device specification sheets, SHARP takes no responsibility for any defects that may occur in equipment using any SHARP devices shown in catalogs, data books, etc.
Except where specially indicated, models listed on this page comply with the RoHS Directive*. For details, please contact SHARP.
*RoHS Directive: Prohibits use of lead, cadmium, hexavalent chromium, mercury and specific brominated flame retardants (PBBs and PBDEs), with certain exceptions.
Contact SHARP in order to obtain the latest device specification sheets before using any SHARP device.



System LSIs

Model No.	Function	Features	Supply voltage (V)	Package
LR35501	One-chip graphic controller	<ul style="list-style-type: none"> Built-in video encoder (NTSC/PAL) Composite signal output Analog RGB signal output Capable of moving picture transmission/play, thanks to real-time image compression and extension technology Real images, backgrounds and sprites can be superimposed Built-in sprite graphic processor Built-in color object detector Built-in Bluetooth® HCI controller Built-in sound generator (ADPCM/PSG) Built-in CMOS camera interface (9 MHz) CPU: Z80 compatible, 27 MHz Peripherals (NAND flash I/F, PIO, SIO, UART, ADC, PWM, etc.) 	Core: 1.8±0.18 I/O: 3.3±0.3	P-QFP128-1420
LR35503	One-chip graphic controller	<ul style="list-style-type: none"> Digital LCD interface (6-bit RGB), QVGA (320 x 240) compliant 27 MHz digital YUV video input Capable of moving picture transmission/play, thanks to real-time image compression and extension technology Real images, backgrounds and sprites can be superimposed Built-in sprite graphic processor Built-in color object detector (Only for CMOS camera input) Built-in Bluetooth® HCI controller Built-in sound generator (ADPCM/PSG) Built-in CMOS camera interface (9 MHz) CPU: Z80 compatible, 27 MHz Peripherals (NAND flash I/F, PIO, SIO, UART, ADC, PWM, etc.) 	Core: 1.8±0.18 I/O: 3.3±0.3	P-LQFP144-2020

Bluetooth is a trademark of Bluetooth SIG, Inc.
Z80 is a trademark of ZILOG, Inc.

Graphic Display Module with LCDs

Model No.	Function	Features	Supply voltage (V)	Outline dimensions (W × D) (mm)
LR0G934	3.5" LCD graphic display module (incorporating LR35503)	<ul style="list-style-type: none"> LED backlight, QVGA (320 x 240), built-in 3.5" color TFT LCD Built-in LR35503 (one-chip graphic controller with built-in 8-bit CPU) Built-in 64-Mbit NOR flash Video input (composite NTSC) Built-in real-time clock (RTC) External interface Video input, digital input/output (shared 2 ch UART), analog input (4 ch ADC), sound output, battery backup terminal (RTC use) 	5±0.5	87.4 × 69.2
LR0G938	3.5" LCD graphic display module with touch panel function (incorporating LR35503)	<ul style="list-style-type: none"> LED backlight, QVGA (320 x 240), built-in 3.5" color TFT LCD Touch panel function Built-in LR35503 (one-chip graphic controller with built-in 8-bit CPU) Built-in 64-Mbit NOR flash Video input (composite NTSC) Built-in real-time clock (RTC) External interface Video input, digital input/output (shared 2 ch UART), analog input (4 ch ADC), sound output, battery backup terminal (RTC use) 	5±0.5	87.4 × 69.2

Notice

In the absence of confirmation by device specification sheets, SHARP takes no responsibility for any defects that may occur in equipment using any SHARP devices shown in catalogs, data books, etc.
Except where specially indicated, models listed on this page comply with the RoHS Directive*. For details, please contact SHARP.
*RoHS Directive: Prohibits use of lead, cadmium, hexavalent chromium, mercury and specific brominated flame retardants (PBBs and PBDEs), with certain exceptions.
Contact SHARP in order to obtain the latest device specification sheets before using any SHARP device.



■ One-chip Graphic Controller <LR35501/LR35503>

LR35501/LR35503 are the system LSIs which enable smooth graphic display by graphic controller with built-in microcomputers and device control and graphic display with one chip due to the microcomputers and various I/Os.

Common features

Built-in versatile graphic functions

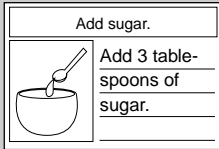

- Smooth imaging using sprite processor
- Capable of moving picture transmission/play, thanks to real-time image compression technology
- Real images, backgrounds and sprites can be superimposed

Graphic expression with smooth movement is possible

Sound output

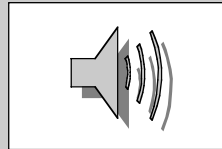

- Built-in stereo sound circuit
- ADPCM decoder
- Programmable sound generator

Warning using realistic alarm tone / audio is possible

CMOS camera interface



- CIF/QVGA UYVY input

CIF/QVGA CMOS imager can be connected

Bluetooth®



- Built-in HCI controller
- SPP, HID compliant

Smooth images transmission achieved by using Bluetooth®

General purpose I/O built-in PIO/UART/SIO/NAND flash interface/ADC/PWM/SPI, etc.

LR35501 features and functions

- Built-in video encoder (NTSC/PAL)
- Built-in analog RGB output
- Built-in composite video output

LR35503 features and functions

- Built-in digital LCD interface (6-bit RGB QVGA [320 x 240])
- Built-in 27 MHz YUV digital video input

Intellectual training toy (Driving game)

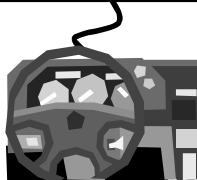
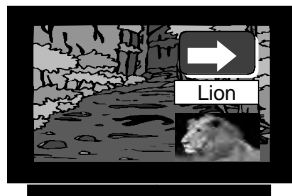

Directly connected to TV (composite) output

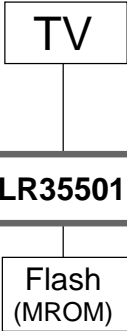

Household electrical appliance

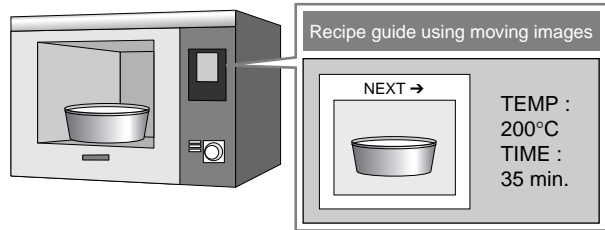

Smooth graphics achieved by simple circuits

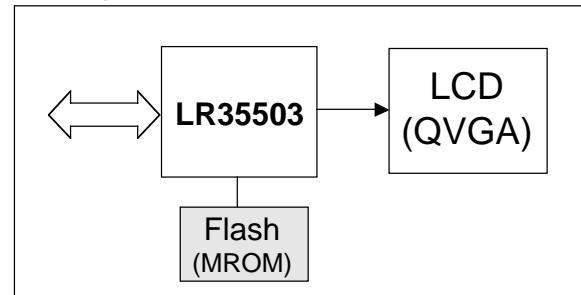

Bluetooth is a trademark of Bluetooth SIG, Inc.

■ IrSimple™ Communications Series <LR388J4/LR388G9/LR388D8/LR388D1>

IrSimple™ communications is a communications protocol which makes the Ir communication standard employed in mobile terminals such as mobile phones, IrDA protocol, more efficient. Compared with IrDA, since the data transfer time can be significantly reduced to approximately 1/4th to 1/10th, higher volumes of data can be sent and received. In addition, by incorporating a controller for IrSimple™ communications into mobile equipment or digital home appliances, high-quality image data taken with a digital camera or a mobile phone camera can be readily transferred to a TV or a printer at high speed with a simple operation such as with a remote controller. The image data captured from the camera can be enjoyed on full HD-TV, or by printing the data out.

● Features

● **LR388J4**
(MDDI*1/MIPI*2-compliant HXGA 3D LCD controller for IrSimple™)
The 2D-3D image conversion function is incorporated into LR388G9.
The 3D-LCD system in smart phones or tablet-type devices can be achieved with a single chip.

● **LR388G9**
(MDDI*1/MIPI*2-compliant HXGA LCD controller for IrSimple™)
The LR388G9 can display on up to HXGA-sized LCD displays. For incorporating 32-Mbit embedded memory, FHD-sized (1 920 x 1 080) external output is available with HDMI. Also, by adding on MIPI*2 interface, the LR388G9 can be used in wide range of application systems.

● **LR388D8**
(MDDI*1-compliant WVGA LCD controller for IrSimple™)
The LR388D1 has been made compatible with full-WVGA LCD displays, with internal memory (16 Mbits) that can hold two screens of data (main and sub). High-resolution display and low power consumption have been realized. Furthermore, a built-in SD card interface supports a reduction in the number of chips.

● **LR388D1**
(MDDI*1-compliant WQVGA LCD controller for IrSimple™)
Thanks to a built-in IrSimple™ function in the LCD controller, the mounting area of a mobile phone can be decreased; thus it contributes to size reduction in mobile phones. Also, a higher volume of data can be transferred at high speed with 4 fewer signal lines due to the incorporation of an MDDI*1 interface.

*1 MDDI (Mobile Display Digital Interface) : The serial interface standard developed by QUALCOMM

*2 MIPI : Mobile Industry Processor Interface

● Application & System Configuration Example

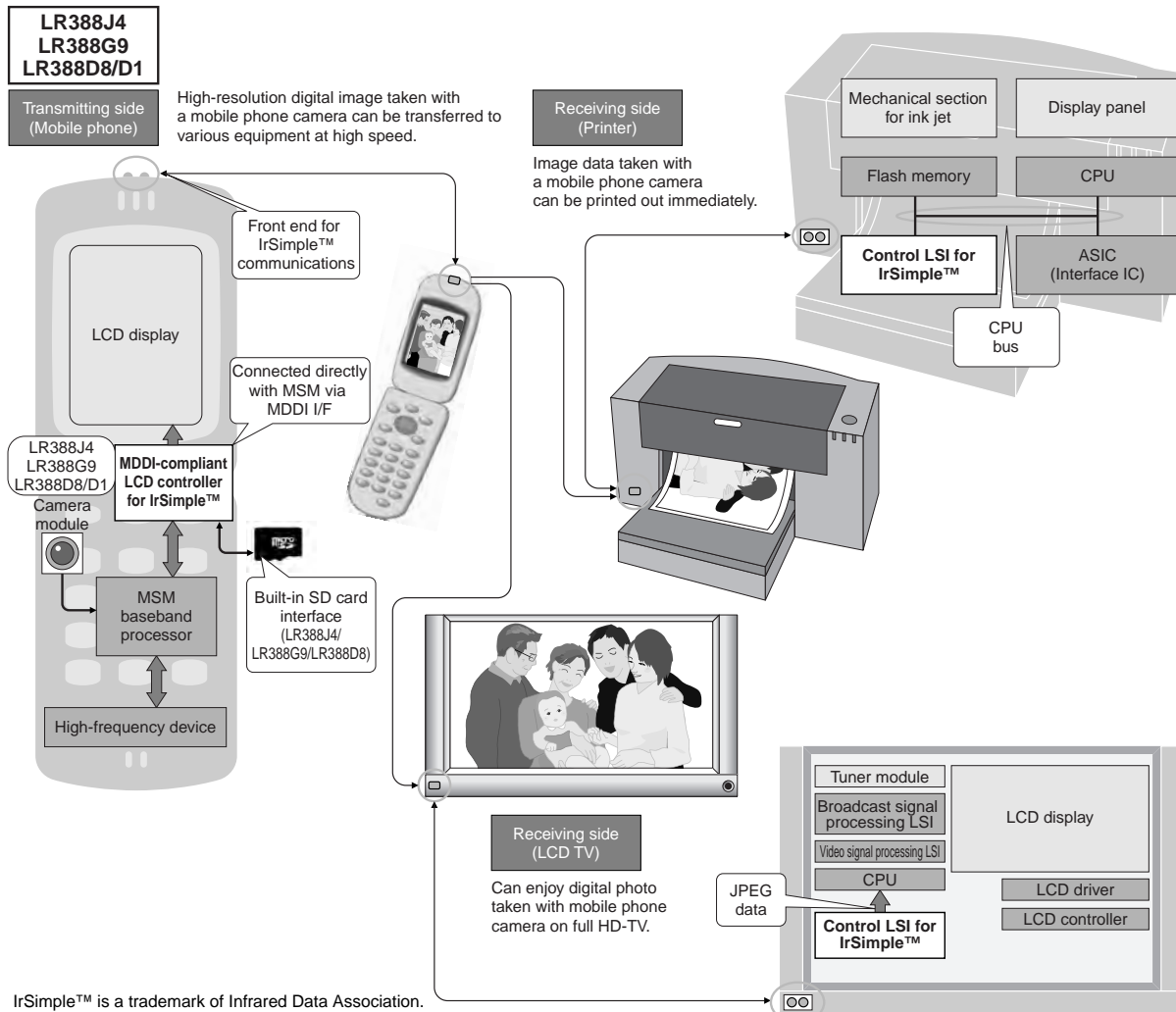

IrSimple™ is a trademark of Infrared Data Association.
QUALCOMM and MSM are trademarks of QUALCOMM Incorporated.

Low Power-Loss Voltage Regulators

TO-220 type

(Ta = 25°C)

Model No.	Features	Absolute maximum ratings				Electrical characteristics			Built-in functions						Package
		Output current I _o (A)	Input voltage V _{in} (V)	Power dissipation (W)		Output voltage V _o *3 (V) TYP.	Output voltage precision (%)	Dropout voltage V _{i-o} *5 (V)	Overheat protection	Overcurrent protection	ON/OFF control	Low dissipation current at OFF state	Variable output voltage	Lead forming available	
				Pd*1	Pd*2										
PQxxxRDA1SZH series	ASO protection function, low dissipation current at OFF state (I _{qs} : 5 μA (MAX.))	1	24	1.4	15	3.3, 5, 8, 9, 12	±3	0.5	○	○	○	○			A
PQxxxRDA2SZH series		2	20			3.3, 5, 9, 12	±2.5	1.0	○	○	○	○			A
PQ070XF01SZH	Minimum operating input voltage: 2.35 V (4 terminals)	1	10	1.4	15	1.5 to 7	±2*4	0.5	○	○			○		A
PQ070VK01FZH	Minimum operating input voltage: 2.35 V (5 terminals)	1							○	○	○	○	○	○	○
PQ070VK02FZH		2	○	○	○	○	○	○	○	○	E				
PQ150RWA2SZH	ASO protection function	2	20	1.4	15	3.0 to 15	±2.5*4	1.0	○	○					A
PQ30RV11J00H	Variable output voltage	1	35	1.5	18	1.5 to 30	±2*4	0.5	○	○	△*6		○	○	B
PQ30RV21J00H		2							○	○	△*6		○	○	B
PQ30RV31J00H		3	2	20	○	○	△*6		○	○	B				

*1 At self-cooling

*2 With infinite heat sink attached

*3 The xxx in the model No. refer to the output voltage values of the model (e.g. 050 for 5 V, 120 for 12 V, 015 for 1.5 V).

*4 Reference voltage precision

*5 Current ratings are defined individually.

*6 △ : Available by adding circuit

*7 Refer to page 41

Surface Mount Type Low Power-Loss Voltage Regulators

SOT-89 type

(Ta = 25°C)

Model No.	Features	Absolute maximum ratings			Electrical characteristics			Built-in functions					Package	
		Output current I _o (A)	Input voltage V _{in} (V)	Power dissipation Pd*1 (W)	Output voltage V _o *2 (V) TYP.	Output voltage precision (%)	Dropout voltage V _{i-o} *3 (V)	Overheat protection	Overcurrent protection	ON/OFF control	Low dissipation current at OFF state	Variable output voltage		
PQ1LAXx5MSPQ	Compact, high radiation package, ceramic capacitor compatible	0.5	15	0.9	1.2, 1.5, 1.8, 2.5, 3.3, 5.0	±2.0	0.7	○	○	○	○			SOT-89
PQ1LAX95MSPQ	Ceramic capacitor compatible, variable output voltage				1.5 to 9.0	±2.0*4		○	○	○	○	○		

*1 When mounted on a board

*2 The xx in the model No. refer to the output voltage values of the model (e.g. 25 for 2.5 V, 50 for 5.0 V).

*3 Current ratings are defined individually.

*4 Reference voltage precision

Notice

In the absence of confirmation by device specification sheets, SHARP takes no responsibility for any defects that may occur in equipment using any SHARP devices shown in catalogs, data books, etc.

Except where specially indicated, models listed on this page comply with the RoHS Directive*. For details, please contact SHARP. *RoHS Directive: Prohibits use of lead, cadmium, hexavalent chromium, mercury and specific brominated flame retardants (PBBs and PBDEs), with certain exceptions.

Contact SHARP in order to obtain the latest device specification sheets before using any SHARP device.



●SC-63 type (1) Output voltage fixed type

(Ta = 25°C)

Model No.	Features	Absolute maximum ratings			Electrical characteristics				Built-in functions						Package		
		Output current I _o (A)			Input voltage V _{in} (V)	Power dissipation P _d *1 (W)	Output voltage V _o *2 (V) TYP.	Output voltage precision (%)	Dropout voltage V _{1-o} *4 (V)	Overheat protection	Overcurrent protection	ON/OFF control	Low dissipation current at OFF state	Variable output voltage		Taped package	
		0.5	1	1.5													
PQxxxDNA1ZPH series	Ceramic capacitor compatible, ASO protection function, low dissipation current at OFF state (I _{qs} : 5 μA (MAX.)), solder dip compatible lead shape	○			24	8	3.3, 5, 9, 12	±2.5	0.5	○	○	○	○	-	○	SC-63	G
PQxxxENA1ZPH series		○								8	1.5, 1.8, 2.5, 3.3	○	○	○	○		
PQxxxENB1ZPH series	Minimum operating input voltage: 2.35 V, ceramic capacitor compatible, solder dip compatible lead shape	○			10	5	1.2, 1.5, 1.8, 2.5, 3.3	±2.0	0.3	○	○	○	○	-	○		G
PQxxxENAHZPH series				○						1.5, 1.8, 2.5, 3.3	0.9	○	○	○	○		-
PQxxxGN01ZPH series	Minimum operating input voltage: 1.7 V (Dual power supply type), ceramic capacitor compatible, solder dip compatible lead shape	○			5.5	8	1.0, 1.2	±30 mV	-	○	○			-	○		G
PQxxxGN1HZPH series				○									○	○			

*1 With infinite heat sink attached

*2 The xxx in the model No. refer to the output voltage values of the model (e.g. 033 for 3.3 V, 050 for 5 V, 120 for 12 V).

*3 The value is defined as ±50 mV in some models.

*4 Current ratings are defined individually.

*5 Refer to page 41

●SC-63 type (2) Output voltage variable type

(Ta = 25°C)

Model No.	Features	Absolute maximum ratings			Electrical characteristics				Built-in functions						Package		
		Output current I _o (A)			Input voltage V _{in} (V)	Power dissipation P _d *1 (W)	Output voltage V _o (V) TYP.	Output voltage precision (%)	Dropout voltage V _{1-o} *3 (V)	Overheat protection	Overcurrent protection	ON/OFF control	Low dissipation current at OFF state	Variable output voltage		Taped package	
		0.5	1	1.5													
PQ070XNA1ZPH	Minimum operating input voltage: 2.35 V, ceramic capacitor compatible, solder dip compatible lead shape	○			10	8	1.5 to 7	±2.0*2	0.5	○	○	○	○	○	○	SC-63	G
PQ070XNAHZPH				○					0.9	○	○	○	○	○	○		G
PQ070XNA2ZPH				○ (2A)					0.5	○	○	○	○	○	○		G
PQ070XNB1ZPH			○							5	1.2 to 7	0.3	○	○	○		○
PQ035ZN01ZPH	Reference voltage (V _{ref}): 0.6 V, minimum operating input voltage: 1.7 V (Dual power supply type), ceramic capacitor compatible, solder dip compatible lead shape	○			5.5	8 to 3.5	±30 mV	-	○	○			○	○	G		
PQ035ZN1HZPH				○				-	○	○			○	○	G		
PQ200WNA1ZPH	Minimum operating input voltage: 3.5 V, ASO protection function, low dissipation current at OFF state (I _{qs} : 5 μA (MAX.)), ceramic capacitor compatible, solder dip compatible lead shape	○			24	8	3.0 to 20	±2.5*2	0.5	○	○	○	○	○	○	G	
PQ200WN3MZPH		○ (0.3)								6.8	5.0 to 20	○	○	○	○		○

*1 With infinite heat sink attached

*2 Reference voltage precision

*3 Current ratings are defined individually.

*4 Refer to page 41

Notice

In the absence of confirmation by device specification sheets, SHARP takes no responsibility for any defects that may occur in equipment using any SHARP devices shown in catalogs, data books, etc.

Except where specially indicated, models listed on this page comply with the RoHS Directive*. For details, please contact SHARP. *RoHS Directive: Prohibits use of lead, cadmium, hexavalent chromium, mercury and specific brominated flame retardants (PBBs and PBDEs), with certain exceptions.

Contact SHARP in order to obtain the latest device specification sheets before using any SHARP device.



●TO-263 type

(Ta = 25°C)

Model No.	Features	Absolute maximum ratings			Electrical characteristics			Built-in functions					Taped package	Package
		Output current I _o (A)	Input voltage V _{in} (V)	Power dissipation P _d *1 (W)	Output voltage V _o (V) TYP.	Output voltage precision (%)	Dropout voltage V _{l-o} *3 (V)	Overheat protection	Overcurrent protection	ON/OFF control	Low dissipation current at OFF state	Variable output voltage		
PQ070XHA2ZPH	2 A output (minimum operating input voltage: 2.35 V), ceramic capacitor compatible	2.0	10	35	1.5 to 7	±2.0*2	0.5	○	○	○	○	○	○	TO-263

*1 With infinite heat sink attached

*2 Reference voltage precision

*3 Current ratings are defined individually.

●SOP-8 type

(Ta = 25°C)

Model No.	Features	Absolute maximum ratings			Electrical characteristics		Built-in functions			Taped package	Package
		Output current I _o (A)	Input voltage V _{in} (V)	Power dissipation P _d *1 (W)	Output voltage V _o (V) TYP.	Output voltage precision*2 (mV)	Overheat protection	Overcurrent protection			
PQ1DX095MZPQ	Built-in sink source function (For DDR II memory)	±0.8	6	0.6	V _{DD} x 1/2 (V _{DDQ} : 1.5 V (MIN.))	±25	○	○	○	SOP-8	
PQ1DX125MZPQ	Built-in sink source function (For DDR memory)				V _{DD} x 1/2 (V _{DDQ} : 2.3 V (MIN.))	±35	○	○	○		

*1 When mounted on a board

*2 Reference voltage precision

Notice

In the absence of confirmation by device specification sheets, SHARP takes no responsibility for any defects that may occur in equipment using any SHARP devices shown in catalogs, data books, etc.

Except where specially indicated, models listed on this page comply with the RoHS Directive*. For details, please contact SHARP. *RoHS Directive: Prohibits use of lead, cadmium, hexavalent chromium, mercury and specific brominated flame retardants (PBBs and PBDEs), with certain exceptions.

Contact SHARP in order to obtain the latest device specification sheets before using any SHARP device.



■ Surface Mount Type Chopper Regulators (DC-DC Converters)

(Ta = 25°C)

Model No.	Features	Absolute maximum ratings		Electrical characteristics					Package	
		Switching current I _{sw} (A)	Power dissipation P _d *1 (W)	Input voltage range V _{in} (V)	Output voltage*2 V _o (V)	Output type	Oscillation frequency f _o (Hz) TYP.	Output saturation voltage V _{sat} (V) TYP.	Outline shape type*4	
PQ6CU12X2APQ	<ul style="list-style-type: none"> High switching voltage: 40 V (MAX.) For tuner power supply Variable oscillation frequency Ceramic capacitor compatible 	0.25	0.35	3.0 to 5.5	up to 36	Step-up	300 k to 800 k	R _{on} TYP. 1.7Ω	SOT-23-6W	
PQ1CN38M2ZPH	<ul style="list-style-type: none"> PWM chopper regulator (high oscillation frequency) Output ON/OFF control function Overcurrent/overheat protection circuits For light load 	0.8	8	4.5 to 40	V _{REF} *3 to 35 (step-down type)/ -V _{REF} to -30 (inverting type)	Step-down	300 k	0.9	G	
PQ1CN41H2ZPH	<ul style="list-style-type: none"> PWM chopper regulator (high oscillation frequency) Overcurrent/overheat protection circuits 	1.5	8			Step-down	300 k	0.9	SC-63	
PQ1CZ21H2ZPH	<ul style="list-style-type: none"> PWM chopper regulator Output ON/OFF control function Overcurrent/overheat protection circuits Low dissipation current at OFF state (Standby current <I_{SD}>: 1 μA (MAX.)) 		8			Step-down	100 k	0.9	F	
PQ1CX41H2ZPQ	<ul style="list-style-type: none"> Bootstrap system for high efficiency (Efficiency 90% (TYP.)) Low voltage output: 0.8 V (MIN.) Ceramic capacitor compatible 	1.5	0.8 When mounted on board	4.75 to 27	0.8 to 20	Step-down	400 k	R _{DSON} TYP. 0.45Ω	SOP-8	
PQ1CX53H2MPQ	<ul style="list-style-type: none"> Bootstrap system for high efficiency (Efficiency 89% (TYP.)) Low voltage output: 0.8 V (MIN.) Ceramic capacitor compatible 	3.5	2 When mounted on board	4.75 to 27	0.8 to 16	Step-down	400 k	R _{DSON} TYP. 0.15Ω	USB-8	
PQ1CX61H1ZPQ	<ul style="list-style-type: none"> Bootstrap system for high efficiency (Efficiency 88% (TYP.)) Low voltage output: 1.0 V (MIN.) Ceramic capacitor compatible 	1.5	0.8 When mounted on board	4.75 to 28	1.0 to 18.9	Step-down	900 k	R _{DSON} TYP. 0.55Ω	SOP-8	
PQ1CY1032ZPH	<ul style="list-style-type: none"> PWM chopper regulator Output ON/OFF control function Overheat protection/overcurrent shutdown circuits High output current type 	3.5	35	4.5 to 40	V _{REF} *3 to 35 (step-down type)/ -V _{REF} to -30 (inverting type)	Step-down	150 k	1.4	TO-263	

*1 With infinite heat sink attached or when mounted on a board listed in the specification sheets.

*2 Output variable range (step-down/inversion).

*3 V_{REF} nearly equal to 1.26 V

*4 Refer to page 41

Notice

In the absence of confirmation by device specification sheets, SHARP takes no responsibility for any defects that may occur in equipment using any SHARP devices shown in catalogs, data books, etc. Except where specially indicated, models listed on this page comply with the RoHS Directive*. For details, please contact SHARP. *RoHS Directive: Prohibits use of lead, cadmium, hexavalent chromium, mercury and specific brominated flame retardants (PBBs and PBDEs), with certain exceptions.

Contact SHARP in order to obtain the latest device specification sheets before using any SHARP device.

Chopper Regulators (DC-DC Converters)

●TO-220 type

(Ta = 25°C)

Model No.	Features	Absolute maximum ratings		Electrical characteristics					Package	
		Switching current I _{sw} (A)	Power dissipation Pd*1 (W)	Input voltage range V _{in} (V)	Output voltage V _o *2 (V)	Output type	Oscillation frequency f _o (kHz) TYP.	Output saturation voltage V _{sat} (V) TYP.	Outline shape type*5	
PQ1CG38M2FZH	<ul style="list-style-type: none"> • PWM chopper regulator (high oscillation frequency) • Built-in overcurrent/overheat protection circuits • For light load • Output ON/OFF control function 	0.8*3					300	0.95	TO-220	E
PQ1CG38M2RZH										D
PQ1CG21H2FZH	<ul style="list-style-type: none"> • PWM chopper regulator • Built-in overcurrent/overheat protection circuits • Output ON/OFF control function 	1.5*3					100	1.0	TO-220	E
PQ1CG21H2RZH										D
PQ1CG41H2FZH	<ul style="list-style-type: none"> • PWM chopper regulator (high oscillation frequency) • Built-in overcurrent/overheat protection circuits • Output ON/OFF control function 	1.5*3	14	40	V _{REF} *4 to 35 (step-down type)/ -V _{REF} *4 to -30 (inverting type)	Step-down	300	1.0	TO-220	E
PQ1CG41H2RZH										D
PQ1CG2032FZH	<ul style="list-style-type: none"> • PWM chopper regulator • Built-in overcurrent/overheat protection circuits • Output ON/OFF control function 	3.5*3					70	1.4	TO-220	E
PQ1CG2032RZH										D
PQ1CG3032FZH	<ul style="list-style-type: none"> • PWM chopper regulator (high oscillation frequency) • Built-in overcurrent/overheat protection circuits • Output ON/OFF control function 	3.5*3					150	1.4	TO-220	E
PQ1CG3032RZH										D

*1 With infinite heat sink attached

*2 Output voltage variable range

*3 Peak current

*4 V_{REF} nearly equal to 1.26 V (TYP.)

*5 Refer to page 41

DC-DC Converter Module with Built-in Coil

(Ta = 25°C)

Model No.	Features	Absolute maximum ratings		Electrical characteristics					Outline dimensions (W x D x H) mm
		Output current I _o (A)	Operating temperature T _{opr} (°C)	Control system	Input voltage range V _{in} (V)	Oscillation frequency f _o TYP. (MHz)	Output voltage V _o *1 (V)	Standby current I _{sd} (μA) TYP.	
☆PQ5CM03P	<ul style="list-style-type: none"> • DC-DC converter module with built-in coil for simplified power-supply design • High efficiency thanks to synchronous rectification method (efficiency: 81%) 	3.0	-10 to +85	PWM system	8.0 to 14	1.0	1.1 to 3.3	20	9.0 x 6.0 x 2.6

*1 Output voltage variable range

Notice

In the absence of confirmation by device specification sheets, SHARP takes no responsibility for any defects that may occur in equipment using any SHARP devices shown in catalogs, data books, etc.

Except where specially indicated, models listed on this page comply with the RoHS Directive*. For details, please contact SHARP. *RoHS Directive: Prohibits use of lead, cadmium, hexavalent chromium, mercury and specific brominated flame retardants (PBBs and PBDEs), with certain exceptions.

Contact SHARP in order to obtain the latest device specification sheets before using any SHARP device.



■ Power Supply ICs for CCDs/CCD Camera Modules

Model No.	No. of output circuits	Input voltage range (V)	Output voltage (V)	System	Switching frequency (Hz)	Switching transistor	Switching current (mA) [Built-in SW Tr]	Drive capacity (pF) [External SW Tr]	Package
IR3M63U	4	4.5 to 10	15	Charge pump	200 k	-	12 (DC)	-	P-VQFN032-0505
			-8	Negative charge pump			2.5 (DC)	-	
			3.3	Step-down type PWM + REG	1 M	Built-in	120 (DC)	-	
			1.8	Step-down type PWM + REG			50 (DC)	-	
IR3M59U	3	4.5 to 16	15/12	Charge pump	200 k	-	12/20 (DC)	-	P-VQFN032-0505
			-8/-5	Negative charge pump			2.5/5 (DC)	-	
			3.3	Step-down type PWM + REG	1 M	Built-in	150 (DC)	-	

Notice

In the absence of confirmation by device specification sheets, SHARP takes no responsibility for any defects that may occur in equipment using any SHARP devices shown in catalogs, data books, etc.
 Except where specially indicated, models listed on this page comply with the RoHS Directive*. For details, please contact SHARP.
 *RoHS Directive: Prohibits use of lead, cadmium, hexavalent chromium, mercury and specific brominated flame retardants (PBBs and PBDEs), with certain exceptions.
 Contact SHARP in order to obtain the latest device specification sheets before using any SHARP device.

LED Drivers

●Built-in step-up circuit (1)

Model No.	Function	Features	No. of output circuits	Number of LEDs	Booster method	Constant current circuit	Switching transistor	Input voltage range (V)	Output ^{*3} current (mA) MAX.	Oscillation frequency (Hz) TYP.	Package
PQ6CB11X1CP	White LED driver for backlight (for small panels)	<ul style="list-style-type: none"> High voltage CMOS output: 30 V (MAX.) Output ON/OFF control function Overvoltage/overcurrent protection circuits Soft start function 	1	6 (Series connection)	PWM	*1	○	2.7 to 5.5	250 ^{*2}	1.2 M	USB-6
PQ7L2020BP		<ul style="list-style-type: none"> High voltage CMOS output: 37 V (MAX.) Output ON/OFF control function Overvoltage/overcurrent protection circuits Soft start function Possible to use a low-capacity (0.1 μF) output capacitor 	1	9 (Series connection)		*1	○	2.9 to 5.5	500	1.0 M	USB-6
PQ7L3010QPF	White LED driver for flashlight	<ul style="list-style-type: none"> Automatic-switching (between 1x/2x) charge pump system Non-external coil Built-in fail-safe function Short-circuit LED protection function/overheat protection function/soft start function 	1	1	Charge pump	*1	—	2.6 to 4.4	800	0.9 M	16QFN
IR2E49U/ IR2E49M	White LED driver for backlight	<ul style="list-style-type: none"> Capable of driving a maximum of 40 LEDs with 8 LEDs (in series) per channel Built-in step-up DC-DC controller Capable of controlling brightness using PWM control Step-up output control according to LED-Vf 	5	40	PWM	○	External	6 to 28	150/ch ^{*4}	100 k to 1 M ^{*5}	P-VQFN036-0606/ P-QFP048-0707
IR2E63Yx	LED driver for backlight and call alert display (auto brightness adjustment)	<ul style="list-style-type: none"> Capable of driving 9 main-LEDs + 2 sub-LEDs (series) and 6 call alert LEDs (RGB) Auto brightness adjustment and PWM brightness adjustment Power supply for EL panel and LCD controller LDO 4ch Built-in input terminals for ambient light sensor and proximity sensor I²C/SPI interface-compatible 	9	15	PWM + charge pump	○	○	3 to 4.2 (for drive)/ 1.62 to 3.2 (for control)	Main 25.6/ch Call alert 12.8/ch	1 M	63WL-CSP ^{*6}
☆IR2E68Yx	LED driver for backlight and call alert display (auto brightness adjustment)	<ul style="list-style-type: none"> Capable of driving 10 main-LEDs + 2 sub-LEDs (series) and 6 call alert LEDs (RGB) Auto brightness adjustment and PWM brightness adjustment Power supply for EL panel and LCD controller LDO 4ch Built-in input terminals for ambient light sensor and proximity sensor I²C/SPI interface-compatible 	10	16	PWM + charge pump	○	○	3 to 4.2 (for drive)/ 1.62 to 3.2 (for control)	Main 25.6/ch Call alert 12.8/ch	1 M or 500 k	63WL-CSP ^{*6}
IR2E56U6	White LED driver for backlight	<ul style="list-style-type: none"> Capable of driving a maximum of 72 LEDs with 12 LEDs (in series) per channel Built-in step-up DC-DC controller High oscillation frequency (1.5 MHz) makes use of a small coil possible Capable of controlling brightness using PWM control Step-up output control according to LED-Vf Built-in sequential drive mode for output current 	6	72	PWM	○	External	5 to 28	25/ch	200 k to 1.5 M	32VQFN
IR2E58U		<ul style="list-style-type: none"> Capable of driving a maximum of 96 LEDs with 12 LEDs (in series) per channel Built-in step-up DC-DC converter High oscillation frequency (1.5 MHz) makes use of a small coil possible Capable of controlling brightness using PWM control Step-up output control according to LED-Vf 	8	96		○	○	4.5 to 28	40/ch	500 k to 1.5 M	24HQFN

*1 LED constant current value can be set by external resistors.

*2 Peak switching current

*3 Constant current (MAX.)

*4 Use this IC within the range of power dissipation.

*5 Selectable oscillation frequency range

*6 3.57 mm x 3.57 mm x 0.585 mm (TYP.)

Notice

In the absence of confirmation by device specification sheets, SHARP takes no responsibility for any defects that may occur in equipment using any SHARP devices shown in catalogs, data books, etc.

Except where specially indicated, models listed on this page comply with the RoHS Directive*. For details, please contact SHARP.
*RoHS Directive: Prohibits use of lead, cadmium, hexavalent chromium, mercury and specific brominated flame retardants (PBBs and PBDEs), with certain exceptions.

Contact SHARP in order to obtain the latest device specification sheets before using any SHARP device.



●Built-in step-up circuit (2)

Model No.	Function	Features	No. of output circuits	Number of LEDs	Booster method	Constant current circuit	Switching transistor	Input voltage range (V)	Output ^{*1} current (mA) MAX.	Oscillation frequency (Hz) TYP.	Package
IR2E65U	White LED driver for backlight	<ul style="list-style-type: none"> Capable of driving a maximum of 120 LEDs with 12 LEDs (in series) per channel Built-in step-up DC-DC controller High oscillation frequency (1.5 MHz) makes use of a small coil possible Wider range of PWM brightness control possible, from simultaneous total output control to local dimming Step-up output control according to LED-Vf 	10	120	PWM	○	External	10 to 28	100/ch	500 k to 1.5 M	52HQFN
☆IR2E67M		<ul style="list-style-type: none"> Built-in 10 ch. constant-current control amplifier (external output transistor) Enables driving LEDs up to external transistor voltage limit Built-in timing controller for lighting Wider range of PWM brightness control possible, from simultaneous total output control to local dimming Step-up output control according to LED-Vf 	10	*2	*3	*4	—	4.5 to 5.5	*5	—	80LQFP-1420

*1 Constant current (MAX.)

*2 Determined by external transistor voltage limit.

*3 Built-in feedback voltage-generating circuit for external power supply.

*4 Built-in constant-current control amplifier (external output transistor)

*5 Determined by external resistor.

●External power supply for LEDs

Model No.	Function	Features	Supply voltage (V)	Package
IR2D20U	24-dot LED panel driver with constant-current sink outputs	<ul style="list-style-type: none"> Output current (constant current sink output): 30 mA (MAX.) (setup by external resistor) Gradation function (clock cycle setting or external synchronization) Independent current control for three systems (for RGB LED) LED drive voltage: 15 V Rated output voltage: 20 V (MAX.) fCLK: 20 MHz (MAX.)/16.6 MHz (MAX.) (at cascade connection) 	4.5 to 5.5	P-HQFN052-0707
IR2D071	16-dot LED panel driver with constant current sink outputs	<ul style="list-style-type: none"> Output current (constant-current sink output): 60 mA (MAX.) (setup by external resistor) Rated output voltage: 7 V (MAX.) fCLK: 20 MHz (MAX.)/16.6 MHz (MAX.) (at cascade connection) 	3.0 to 5.5	P-SDIP028-0400

Notice

In the absence of confirmation by device specification sheets, SHARP takes no responsibility for any defects that may occur in equipment using any SHARP devices shown in catalogs, data books, etc.

Except where specially indicated, models listed on this page comply with the RoHS Directive*. For details, please contact SHARP.
*RoHS Directive: Prohibits use of lead, cadmium, hexavalent chromium, mercury and specific brominated flame retardants (PBBs and PBDEs), with certain exceptions.

Contact SHARP in order to obtain the latest device specification sheets before using any SHARP device.

■ AC-DC Conversion Type ICs for LED Lighting

Model No.	Features	Absolute maximum ratings		Electrical characteristics					Package
		V _{CC} (V)	T _{opr} (°C)	Drive voltage V _{CC} (V) MIN.	Dissipation current I _{CC} (mA) TYP.	Low level output current I _{OL} (mA) MIN.	High level output current I _{OH} (mA) MAX.	Switching frequency F _{SW} (kHz) TYP.	
PQ1DC15C0P	<ul style="list-style-type: none"> Use of forward type allows high (90%) efficiency rate No electrolytic capacitor 	23	-30 to +100	20	3	15	-15	68	SOT-23
PQ1DC15F1P									SOP-8

■ AC Direct Type ICs for LED Lighting

Model No.	Features	Absolute maximum ratings		Electrical characteristics				Package
		V _{IN1} (V)	T _{opr} (°C)	VS terminal voltage VS (V) TYP.	Dissipation current I _{CC} (mA) TYP.	Low level output current for DG terminal IDG2 (μA) MIN.	High level output current for DG terminal IDG1 (μA) MAX.	
☆IR3M85N4	<ul style="list-style-type: none"> Compatible with existing dimmers No electrolytic capacitor 	395	0 to +85	20	1	40	-50	SOP-14

■ Power Supply Modules for LED Lighting

Model No.	Features	Absolute maximum ratings		Electrical characteristics						Outline dimensions (mm)
		V _{AC} (V)	T _{opr} (°C)	Input voltage V _{AC} (V) TYP.	Output voltage V _{out} (V) TYP.	Output current I _{out} (mA) TYP.	Output power P _o (W) TYP.	Efficiency η (%) TYP.	Power factor PF TYP.	
★PQ1AS1D01	<ul style="list-style-type: none"> Step-down type Compatible with existing dimmers High efficiency 	110	-10 to +80	100	31	200	6.2	80	0.9	23 × 42 × 23.6
★PQ1AS1D01A		132		120				82	0.8	
★PQ1AS2D01		253		230				62	100	

■ Power Amplifiers for Wireless LAN

Model No.	Application	Supply voltage V _{CC} (V) TYP.	Control voltage V _{bb} (V) TYP.	Linear output power*1 (dBm)	Dissipation current (mA) TYP.	Gain (dB) TYP.	Detection circuit	Matching circuit	Package (mm)
IRM068U7	For 2.4 GHz single-band wireless LAN (IEEE802.11b/g/n)	3.3	2.8	18	115	27	○*2	Built-in (IN)	HQFN6 pin (1.5 × 1.5 × 0.4 mm)
QM2A1UA003				20	150	28	○	Built-in (IN)	
IRM053U7	For 5 GHz single-band wireless LAN (IEEE802.11a/n)			18	170	30	○	Built-in (IN/OUT)	HQFN10 pin (2 × 2 × 0.4 mm)
QM2A1UA004				20	225	31	○	Built-in (IN/OUT)	
IRM065U7	For 2.4/5 GHz dual-band wireless LAN (IEEE802.11a/b/g/n)			18	130	30	○	Built-in (IN/OUT)	HQFN16 pin (3 × 3 × 0.4 mm)
IRM067U6				18	160	30			
		17	100	28					
			2.9	17	140	30	○*2	Built-in (IN/OUT)	

*1 At time of OFDM 64QAM modulating wave input.

*2 Load fluctuation stabilization and detection output type

Notice

In the absence of confirmation by device specification sheets, SHARP takes no responsibility for any defects that may occur in equipment using any SHARP devices shown in catalogs, data books, etc.
 Except where specially indicated, models listed on this page comply with the RoHS Directive*. For details, please contact SHARP.
 *RoHS Directive: Prohibits use of lead, cadmium, hexavalent chromium, mercury and specific brominated flame retardants (PBBs and PBDEs), with certain exceptions.
 Contact SHARP in order to obtain the latest device specification sheets before using any SHARP device.

Fail Safe ICs

Model No.	Features	Operating voltage			Dissipation current (μA) TYP.	Operating temp. (°C)	Package
		VBAT (V)	VBAC (V)	VIO (V)			
IR3T46U6	<ul style="list-style-type: none"> Malfunction detection Built-in 8-bit ADC Built-in timer circuit Built-in key detection output OR gate 	3.2 to 4.5	3.0 to 3.3	2.6 to 3.0	10	-20 to +85	P-HQFN024-0404
IR3T48Y6	<ul style="list-style-type: none"> Small package Built-in 3-STATE buffer Malfunction detection Built-in 8-bit ADC Built-in timer circuit Built-in key detection output OR gate 			1.6 to 3.0			35WL-CSP*

* 3.0 (W) x 3.0 (D) x 0.975 (H) mm (TYP.)

Solar Modules for Mobile Devices

Model No.	Features	Maximum output power* Pmax (mW) TYP.	Maximum output voltage* Vpm (V) TYP.	Maximum output current* Ipm (mA) TYP.	Outline dimensions (mm)
☆LR0GC023	Module thickness: 0.8 mm	365	4.9	75	67.5 × 41.0 × 0.8
☆LR0GC05	Module thickness: 1.0 mm	160	4.6	35	41.0 × 33.0 × 1.0

* Measuring conditions: AM 1.5; irradiance: 1 000 W/m² ± 50 mW; module temperature: at 25°C

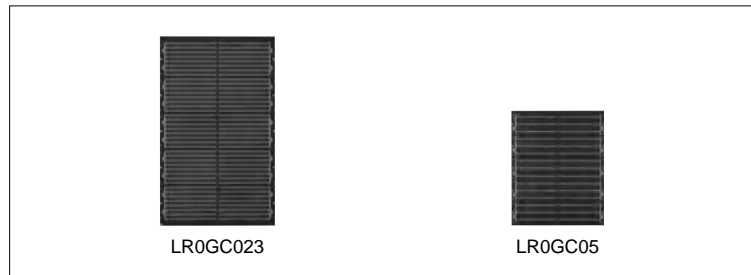

Notice

In the absence of confirmation by device specification sheets, SHARP takes no responsibility for any defects that may occur in equipment using any SHARP devices shown in catalogs, data books, etc.
 Except where specially indicated, models listed on this page comply with the RoHS Directive*. For details, please contact SHARP.
 *RoHS Directive: Prohibits use of lead, cadmium, hexavalent chromium, mercury and specific brominated flame retardants (PBBs and PBDEs), with certain exceptions.
 Contact SHARP in order to obtain the latest device specification sheets before using any SHARP device.



■ CSP

●CSP (Chip Size Package)

The FBGA (commonly known as CSP) has an area array terminal structure with solder balls on the bottom, to give it a near chip-size footprint. This high-density, compact and low-profile package technology will greatly help in the design of compact mobile equipment, such as mobile phones and digital cameras.



FBGA (CSP)

Features

- **Compact and lightweight**
Ability to create a near-chip size and lighter-weight package in comparison with conventional plastic packages.
- **High reliability**
Comparable high reliability with that of conventional plastic packages.
- **Mountability**
Conventional mounting system is available for CSP. SOP and QFP can be mounted together with CSP.

Terminal pitch	0.8 mm	0.65 mm	0.5 mm	0.4 mm
Maximum terminal counts	352 (16 mm x 16 mm)	352 (16 mm x 16 mm)	372 (16 mm x 16 mm)	264 (10 mm x 10 mm)
Nominal dimensions	6 mm x 6 mm to 16 mm x 16 mm			5 mm x 5 mm to 10 mm x 10 mm

Cross section example

●Wafer-level CSP

The wafer-level CSP (WL-CSP) is a kind of chip-size package which is manufactured by assembling directly onto the finished wafer.

Features

- **Compact and thinner size**
It makes it possible to create an almost IC-size and lighter-weight package.
- **Mountability**
The conventional CSP mounting system can be also used in that of wafer-level CSP, which facilitates chip mounting more than bare-chip mounting does. It can be mounted together with other existing packages and passive components. (The use of underfill is recommended to improve the reliability of assembly.)

Chip size*	4 mm x 4 mm		3.5 mm x 3.5 mm		3 mm x 3 mm	
Pad pitch	0.5 mm	0.4 mm	0.5 mm	0.4 mm	0.5 mm	0.4 mm
Maximum terminal counts	49 (7 x 7)	81 (9 x 9)	36 (6 x 6)	49 (7 x 7)	25 (5 x 5)	36 (6 x 6)

* Rectangular chip form is also available.

Cross section example

■ SiP (System in Package)

System in Package is SHARP's original high-density mounting technology that achieves high-density memory capacity and multiple functions by stacking multiple ICs or multiple packages. The System in Package technology means chip-stacked package technology that can achieve up to 5-chip mounting by stacking ICs in a single package. The System in Package technology contributes to higher functionality of applications, such as mobile phones and digital cameras, as well as to reduction in size and weight.

● Chip Stacked CSP

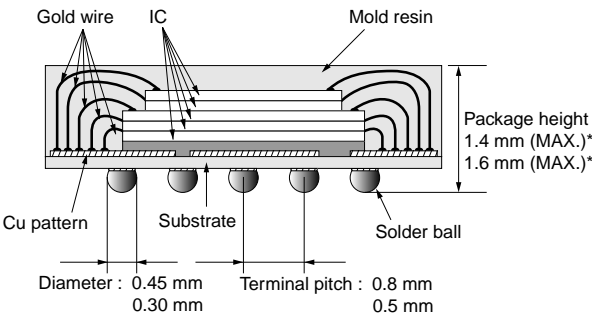
<p>Features</p>	<ul style="list-style-type: none"> ● Wide variety of lineup It is possible to provide a wide lineup of stacked CSPs, including 2-chip, 3-chip, 4-chip and 5-chip stacked CSPs, to respond to customer needs. ● Compact and thinner size Encapsulating multiple ICs into an existing plastic package contributes to decreasing the mounting area. In addition, SHARP's wafer thinning technology makes it possible to achieve 1.4 mm (MAX.) package height. ● Multiple functions Multiple ICs of different sizes and functions, such as logic LSIs and memories, can be incorporated in a single package, making possible multiple functions. ● Same-size IC stacking technology SHARP's stacking technology enables stacking of multiple same-size ICs, contributing to higher memory density. <p>(4-chip stacked CSP) When using a SHARP four-chip stacked CSP, the mounting area and weight of a package can be decreased by half in comparison with using two 2-chip stacked CSPs, or a 3-chip stacked CSP and a conventional CSP.</p>
<p>Cross section example</p>	<p>(5-chip stacked CSP)</p>  <p>Labels in diagram: Gold wire, IC, Mold resin, Package height 1.4 mm (MAX.)*, 1.6 mm (MAX.)*, Cu pattern, Substrate, Solder ball, Diameter : 0.45 mm, 0.30 mm, Terminal pitch : 0.8 mm, 0.5 mm, * At 0.8 mm terminal pitch</p>

Notice

In the absence of confirmation by device specification sheets, SHARP takes no responsibility for any defects that may occur in equipment using any SHARP devices shown in catalogs, data books, etc. Except where specially indicated, models listed on this page comply with the RoHS Directive*. For details, please contact SHARP. *RoHS Directive: Prohibits use of lead, cadmium, hexavalent chromium, mercury and specific brominated flame retardants (PBBs and PBDEs), with certain exceptions. Contact SHARP in order to obtain the latest device specification sheets before using any SHARP device.

●Chip Stacked TSOP/QFP*/VQFN/HQFN

<p>Features</p>	<ul style="list-style-type: none"> ● Decreased mounting area By encapsulating two identical or different types of ICs into a single conventional plastic package, the mounting area of the package can be decreased. ● Multiple functions Thanks to the incorporation of different sizes and functions of multiple ICs, such as logic LSIs and memories, the functionality increases. ● Higher memory density When incorporating two identical memory ICs into a single package, memory density doubles on the same mounting area.
<p>Cross section example</p>	<p>(TSOP, QFP*) (Hamburger type)</p> <p>(Turtle stack type)</p> <p>(VQFN)</p> <p>(HQFN)</p>

* Including TQFP and LQFP.

Notice

In the absence of confirmation by device specification sheets, SHARP takes no responsibility for any defects that may occur in equipment using any SHARP devices shown in catalogs, data books, etc.
 Except where specially indicated, models listed on this page comply with the RoHS Directive*. For details, please contact SHARP.
 *RoHS Directive: Prohibits use of lead, cadmium, hexavalent chromium, mercury and specific brominated flame retardants (PBBs and PBDEs), with certain exceptions.
 Contact SHARP in order to obtain the latest device specification sheets before using any SHARP device.



■ SOF

● SOF (System On Film)

SOF is a highly flexible thin film package, created from SHARP's TCP technologies. It can be easily bent, and contributes to thin and compact design of products. Peripheral circuit components can also be mounted.



Features

- **Highly flexible and thin film package**
By using highly flexible and thin film, SOF contributes to creating thin and compact products. It can also achieve finer terminal pitches and multiple outputs easily, and pattern layout on a film under the chip makes it possible to improve the flexibility of the pattern layout.
- **Multiple chip mounting**
Multiple chip mounting with peripheral chip components contribute to the higher functionality of products.

Cross section example

Film specifications

Film width : W ₁	35 mm super wide	48 mm super wide	70 mm wide
Maximum pattern layout area : W ₂	28.6 mm	41.6 mm	59.0 mm
Maximum device pitch : L	15 sprockets		
Pattern thickness	8 μm		
Pattern layer	Electro-deposited Cu		
Pattern layer finish	Tin (Sn)		
Minimum pattern pitch	0.025 mm		
Sprocket hole : A	1.981 mm (wide) /1.42 mm (super wide)		
Sprocket hole : B	1.981 mm (wide) /1.42 mm (super wide)		

Other components Bare chips and peripheral chip components can be mounted on the film.

Packages

Notice
In the absence of confirmation by device specification sheets, SHARP takes no responsibility for any defects that may occur in equipment using any SHARP devices shown in catalogs, data books, etc. Except where specially indicated, models listed on this page comply with the RoHS Directive*. For details, please contact SHARP. *RoHS Directive: Prohibits use of lead, cadmium, hexavalent chromium, mercury and specific brominated flame retardants (PBBs and PBDEs), with certain exceptions. Contact SHARP in order to obtain the latest device specification sheets before using any SHARP device.



■ Package Lineup

● Surface-mount Type

Package type	Appearance (Package material)	Package code	No. of terminals	Terminal pitch mm	Nominal dimensions mm	Package depth & width (D x W) x (seated height [MAX.] mm)			
FBGA (CSP)		P-LFBGA048-0606	48	0.8	6 x 6	6.0 x 6.0 x (1.4)			
		P-TFBGA048-0608			6 x 8	6.0 x 8.0 x (1.2)			
		P-TFBGA048-0808	56		8 x 8	8.0 x 8.0 x (1.2)			
		P-TFBGA056-0808			60 (48)*	8 x 11	8.0 x 11.0 x (1.2)		
		P-TFBGA060-0811							
		P-TFBGA064-0811							
		P-TFBGA072-0811							
		P-LFBGA072-0811	72 (64)*		8 x 8	8.0 x 11.0 x (1.4) / (1.6)			
		P-TFBGA081-0808	81			8.0 x 8.0 x (1.2)			
		P-LFBGA085-0811	85		8 x 11	8.0 x 11.0 x (1.4) / (1.6)			
		P-LFBGA087-0811	87						
		P-LFBGA088-0811	88		9 x 12	9.0 x 12.0 x (1.4) / (1.6)			
		P-LFBGA088-0912			8 x 11	8.0 x 11.0 x (1.4) / (1.6)			
		P-LFBGA090-0811	90		10 x 10	10.0 x 10.0 x (1.2)			
		P-TFBGA096-1010	96		9 x 12	9.0 x 12.0 x (1.4) / (1.6)			
		P-LFBGA107-0912	107		10 x 10	10.0 x 10.0 x (1.2)			
		P-TFBGA111-1010	111		9 x 14	9.0 x 14.0 x (1.4) / (1.6)			
		P-TFBGA112-1010	112						
		P-LFBGA115-0914	115		10 x 10	10.0 x 10.0 x (1.4) / (1.6)			
		P-LFBGA116-1010	116		10 x 13	10.0 x 13.0 x (1.4) / (1.6)			
		P-LFBGA130-1013	130		11 x 11	11.0 x 11.0 x (1.2)			
		P-TFBGA144-1111	144						
		P-TFBGA160-1212	160		12 x 12	12.0 x 12.0 x (1.2)			
		P-LFBGA168-1212	168						
		P-TFBGA180-1212	180		12.0 x 12.0 x (1.4) / (1.6)	12.0 x 12.0 x (1.2)			
		P-TFBGA184-1212	184						
		P-TFBGA240-1414	240		14 x 14	14.0 x 14.0 x (1.2)			
		P-LFBGA280-1616	280						
		P-LFBGA352-1616	352		16 x 16	16.0 x 16.0 x (1.5)			
		(Plastic)			P-TFBGA064-0606	64	0.65	6 x 6	6.0 x 6.0 x (1.2)
					P-LFBGA140-0909	140		9 x 9	9.0 x 9.0 x (1.4)
					P-LFBGA160-1010	160		10 x 10	10.0 x 10.0 x (1.4) / (1.6)
P-TFBGA180-1313	180			13 x 13	13.0 x 13.0 x (1.2)				
P-LFBGA192-1010	192			10 x 10	10.0 x 10.0 x (1.4) / (1.6)				
P-LFBGA208-1212	208			12 x 12	12.0 x 12.0 x (1.4) / (1.6)				
P-LFBGA224-1313	224			13 x 13	13.0 x 13.0 x (1.4) / (1.6)				
P-TFBGA260-1313	260								

* Figures in brackets indicate available terminal counts.

Notice

In the absence of confirmation by device specification sheets, SHARP takes no responsibility for any defects that may occur in equipment using any SHARP devices shown in catalogs, data books, etc.

Except where specially indicated, models listed on this page comply with the RoHS Directive*. For details, please contact SHARP.

*RoHS Directive: Prohibits use of lead, cadmium, hexavalent chromium, mercury and specific brominated flame retardants (PBBs and PBDEs), with certain exceptions.

Contact SHARP in order to obtain the latest device specification sheets before using any SHARP device.



●Surface-mount Type (cont'd)

Package type	Appearance (Package material)	Package code	No. of terminals	Terminal pitch mm	Nominal dimensions mm	Package depth & width (D x W) x (seated height [MAX.]) mm	
FBGA (CSP)		P-VFBGA057-0505	57	0.5	5 x 5	5.0 x 5.0 x (0.9)	
		P-VFBGA075-0505	75			6 x 6	6.0 x 6.0 x (1.1)
		P-TFBGA064-0606	64				6.0 x 6.0 x (0.9)
		P-TFBGA068-0606	68		6.0 x 6.0 x (1.1)		
		P-VFBGA081-0606	81		100	7 x 7	6.0 x 6.0 x (0.9)
		P-TFBGA084-0606	84				6.0 x 6.0 x (1.1)
		P-VFBGA100-0606					6.0 x 6.0 x (0.9)
		P-VFBGA100-0707	100		108	7 x 7	7.0 x 7.0 x (0.9)
		P-TFBGA100-0707					7.0 x 7.0 x (1.1)
		P-VFBGA108-0707					7.0 x 7.0 x (0.9)
		P-TFBGA108-0707	108		120	7 x 7	7.0 x 7.0 x (1.1)
		P-VFBGA120-0707					7.0 x 7.0 x (0.9)
		P-TFBGA120-0707	120				7.0 x 7.0 x (1.1)
		P-TFBGA132-0707	132		144	8 x 8	8.0 x 8.0 x (1.1)
		P-TFBGA133-0808	133				8.0 x 8.0 x (0.9)
		P-VFBGA144-0808					8.0 x 8.0 x (1.3) / (1.5)
		P-LFBGA144-0808	144		152	8 x 11	8.0 x 11.0 x (1.3)
		P-LFBGA144-0811					8.0 x 8.0 x (1.1)
		P-TFBGA152-0808	152				8.0 x 11.0 x (0.9)
		P-VFBGA171-0811	171		176	8 x 11	8.0 x 11.0 x (1.3) / (1.5)
		P-LFBGA171-0811					9.0 x 9.0 x (0.9)
		P-VFBGA176-0909	176				9.0 x 9.0 x (1.1)
		P-TFBGA176-0909	176		188	9 x 9	9.0 x 9.0 x (1.1)
		P-TFBGA180-0909	180				11.0 x 11.0 x (0.9)
		P-TFBGA188-0909	188				10.0 x 10.0 x (0.9)
		P-VFBGA188-1111			208	11 x 11	11.0 x 11.0 x (0.9)
		P-VFBGA208-1010					10.0 x 10.0 x (0.9)
		P-TFBGA208-1010	208				10.0 x 10.0 x (1.1)
		P-TFBGA245-1010	245		245	10 x 10	10.0 x 10.0 x (1.3)
		P-LFBGA245-1010					10.0 x 10.0 x (1.8)
		P-FBGA424-1414	424				14.0 x 14.0 x (1.8)
		P-WFBGA144-0606	144		121	6 x 6	6.0 x 6.0 x (0.75)
		P-WFBGA121-0606	121				6.0 x 6.0 x (0.8)
P-WFBGA145-0606	145	7.0 x 7.0 x (1.0)					
P-TFBGA168-0707	168	204	7 x 7	7.0 x 7.0 x (1.0)			
P-TFBGA204-0808	204			8.0 x 8.0 x (1.0)			
P-WFBGA205-0808	205			8.0 x 8.0 x (0.8)			
P-WFBGA261-0808	261		8 x 8	8.0 x 8.0 x (0.8)			

(Plastic)

Notice

In the absence of confirmation by device specification sheets, SHARP takes no responsibility for any defects that may occur in equipment using any SHARP devices shown in catalogs, data books, etc.
 Except where specially indicated, models listed on this page comply with the RoHS Directive*. For details, please contact SHARP.
 *RoHS Directive: Prohibits use of lead, cadmium, hexavalent chromium, mercury and specific brominated flame retardants (PBBs and PBDEs), with certain exceptions.
 Contact SHARP in order to obtain the latest device specification sheets before using any SHARP device.

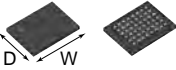
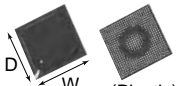

●Surface-mount Type (cont'd)

Package type	Appearance (Package material)	Package code	No. of terminals	Terminal pitch mm	Nominal dimensions mm	Package depth & width (D x W) x (seated height [MAX.]) mm
FBGA (CSP)		P-TFBGAXXX-0606	to 36	0.8	6 x 6	6.0 x 6.0 x (1.2)
		P-TFBGAXXX-0707	to 49		7 x 7	7.0 x 7.0 x (1.2)
		P-TFBGAXXX-0808	to 81		8 x 8	8.0 x 8.0 x (1.2)
		P-TFBGAXXX-0909	to 100		9 x 9	9.0 x 9.0 x (1.2)
		P-TFBGAXXX-1010	to 121		10 x 10	10.0 x 10.0 x (1.2)
		P-TFBGAXXX-1111	to 144		11 x 11	11.0 x 11.0 x (1.2)
		P-TFBGAXXX-1212	to 196		12 x 12	12.0 x 12.0 x (1.2)
		P-TFBGAXXX-1313	to 216		13 x 13	13.0 x 13.0 x (1.2)
		P-TFBGAXXX-1414	to 240		14 x 14	14.0 x 14.0 x (1.2)
		P-TFBGAXXX-1515	to 352		15 x 15	15.0 x 15.0 x (1.2)
		P-TFBGAXXX-1616	to 352	16 x 16	16.0 x 16.0 x (1.2)	
		P-TFBGAXXX-0606	to 49	0.65	6 x 6	6.0 x 6.0 x (1.2)
		P-TFBGAXXX-0707	to 81		7 x 7	7.0 x 7.0 x (1.2)
		P-TFBGAXXX-0808	to 121		8 x 8	8.0 x 8.0 x (1.2)
		P-TFBGAXXX-0909	to 144		9 x 9	9.0 x 9.0 x (1.2)
		P-TFBGAXXX-1010	to 196		10 x 10	10.0 x 10.0 x (1.2)
		P-TFBGAXXX-1111	to 224		11 x 11	11.0 x 11.0 x (1.2)
		P-TFBGAXXX-1212	to 256		12 x 12	12.0 x 12.0 x (1.2)
		P-TFBGAXXX-1313	to 272		13 x 13	13.0 x 13.0 x (1.2)
		P-TFBGAXXX-1414	to 304		14 x 14	14.0 x 14.0 x (1.2)
		P-TFBGAXXX-1515	to 320		15 x 15	15.0 x 15.0 x (1.2)
		P-TFBGAXXX-1616	to 352	16 x 16	16.0 x 16.0 x (1.2)	
		P-TFBGAXXX-0606	to 100	0.5	6 x 6	6.0 x 6.0 x (1.1)
		P-TFBGAXXX-0707	to 132		7 x 7	7.0 x 7.0 x (1.1)
		P-TFBGAXXX-0808	to 164		8 x 8	8.0 x 8.0 x (1.1)
		P-TFBGAXXX-0909	to 192		9 x 9	9.0 x 9.0 x (1.1)
		P-TFBGAXXX-1010	to 216		10 x 10	10.0 x 10.0 x (1.1)
		P-TFBGAXXX-1111	to 244		11 x 11	11.0 x 11.0 x (1.1)
		P-TFBGAXXX-1212	to 268		12 x 12	12.0 x 12.0 x (1.1)
		P-TFBGAXXX-1313	to 296		13 x 13	13.0 x 13.0 x (1.1)
		P-TFBGAXXX-1414	to 320		14 x 14	14.0 x 14.0 x (1.1)
		P-TFBGAXXX-1515	to 348		15 x 15	15.0 x 15.0 x (1.1)
		P-TFBGAXXX-1616	to 372	16 x 16	16.0 x 16.0 x (1.1)	
P-TFBGAXXX-0505	to 100	0.4	5 x 5	5.0 x 5.0 x (1.0)		
P-TFBGAXXX-0606	to 144		6 x 6	6.0 x 6.0 x (1.0)		
P-TFBGAXXX-0707	to 168		7 x 7	7.0 x 7.0 x (1.0)		
P-TFBGAXXX-0808	to 204		8 x 8	8.0 x 8.0 x (1.0)		
P-TFBGAXXX-0909	to 228		9 x 9	9.0 x 9.0 x (1.0)		
P-TFBGAXXX-1010	to 264		10 x 10	10.0 x 10.0 x (1.0)		
	(Plastic)					
PBGA (BGA)		P-BGA0356-2121	356	1.0	21 x 21	21.0 x 21.0 x (2.2)
		P-BGA0476-3535	476	1.27	35 x 35	35.0 x 35.0 x (2.63)
		P-BGA0528-3535	528			

XXX: Terminal counts

BGA is a trademark of Motorola Nippon Ltd.

Notice

In the absence of confirmation by device specification sheets, SHARP takes no responsibility for any defects that may occur in equipment using any SHARP devices shown in catalogs, data books, etc.
 Except where specially indicated, models listed on this page comply with the RoHS Directive*. For details, please contact SHARP.
 *RoHS Directive: Prohibits use of lead, cadmium, hexavalent chromium, mercury and specific brominated flame retardants (PBBs and PBDEs), with certain exceptions.
 Contact SHARP in order to obtain the latest device specification sheets before using any SHARP device.

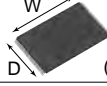
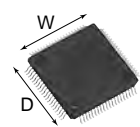
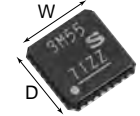
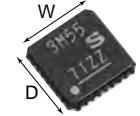

●Surface-mount Type (cont'd)

Package type	Appearance (Package material)	Package code	No. of terminals	Terminal pitch mm (mil)	Nominal dimensions mm (mil)	Package depth & width (D x W) x (seated height [MAX.]) mm	Lead frame material	
							Alloy42	Copper alloy
SSOP	 (Plastic)	P-SSOP008-0150	8	0.65	4.5 (150)	3.0 x 3.0 x (1.1)	-	
		P-SSOP024-0275	24		7.0 (275)	6.0 x 7.8 x (1.27)	-	
TSOP	 (Plastic)	P-TSOP040-1020	40	0.5	10 x 20	10.0 x 18.4 x (1.2)		
		P-TSOP048-1220	48		12 x 20	12.0 x 18.4 x (1.2)		
		P-TSOP056-1420	56		14 x 20	14.0 x 18.4 x (1.2)		
QFP	 (Plastic)	P-QFP048-0707	48	0.5	7 x 7	7.0 x 7.0 x (1.65)		
P-QFP072-1010		72	10 x 10		10.0 x 10.0 x (1.8)		-	
LQFP		P-LQFP080-1212	80	0.5	12 x 12	12.0 x 12.0 x (1.7)		-
		P-LQFP100-1414	100		14 x 14	14.0 x 14.0 x (1.7)		-
TQFP		P-TQFP048-0707	48	0.5	7 x 7	7.0 x 7.0 x (1.2)		-
		P-TQFP100-1414	100					-
		P-TQFP128-1414	128	0.4	14 x 14	14.0 x 14.0 x (1.2)		-
VQFN	 (Plastic)	P-VQFN020-0404	20	0.5	4 x 4	4.2 x 4.2 x (1.0)		-
		P-VQFN024-0404	24					-
		P-VQFN028-0505	28		5 x 5	5.2 x 5.2 x (1.0)		-
		P-VQFN032-0505	32					-
		P-VQFN036-0606	36	0.4	6 x 6	6.2 x 6.2 x (1.0)		-
		P-VQFN048-0707	48		7 x 7	7.2 x 7.2 x (1.0)		-
		P-VQFN036-0505	36		5 x 5	5.2 x 5.2 x (1.0)		-
		P-VQFN052-0707	52		7 x 7	7.2 x 7.2 x (1.0)		-
HQFN*	 (Plastic)	P-HQFN020-0404	20	0.5	4 x 4	4.0 x 4.0 x (1.0)		-
		P-HQFN024-0404	24			4.0 x 4.0 x (0.85)		-
		P-HQFN028-0505	28	0.4	5 x 5	5.0 x 5.0 x (1.0)		-
		P-HQFN052-0707	52		7 x 7	7.2 x 7.2 x (1.0)		-

* HQFN is a higher heat dissipation package of VQFN.

100 mil = 2.54 mm

Notice

In the absence of confirmation by device specification sheets, SHARP takes no responsibility for any defects that may occur in equipment using any SHARP devices shown in catalogs, data books, etc.
 Except where specially indicated, models listed on this page comply with the RoHS Directive*. For details, please contact SHARP.
 *RoHS Directive: Prohibits use of lead, cadmium, hexavalent chromium, mercury and specific brominated flame retardants (PBBs and PBDEs), with certain exceptions.
 Contact SHARP in order to obtain the latest device specification sheets before using any SHARP device.

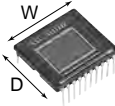
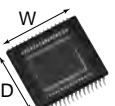
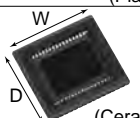

●For CCDs

Package type	Appearance (Package material)	Package code	No. of terminals	Terminal pitch mm	Nominal dimensions mm (mil)	Package depth & width (D x W) x (seated height [TYP.]) mm
DIP	 (Plastic)	P-DIP014-0400A	14	1.27	10.16 (400)	10.0 x 10.0
		P-DIP016-0450	16	1.27	11.43 (450)	11.4 x 12.2
		P-DIP016-0500C		1.78	12.7 (500)	12.4 x 14.0
SOP	 (Plastic)	P-SOP014-0400A	14	1.27	12 (470)	10.0 x 10.0 x (4.1)
		P-SOP028-0400	28	0.69	10.16 (400)	10.0 x 10.0 x (3.5)
		P-SOP032-0525	32	0.78	13.3 (525)	12.0 x 13.8 x (3.92)
LCC	 (Ceramic)	N-LCC040-R350	40	0.65	8.9	8.3 x 8.9 x (1.52)
		N-LCC040-S433A		0.80	11.0	11.0 x 11.0 x (1.62)

100 mil = 2.54 mm

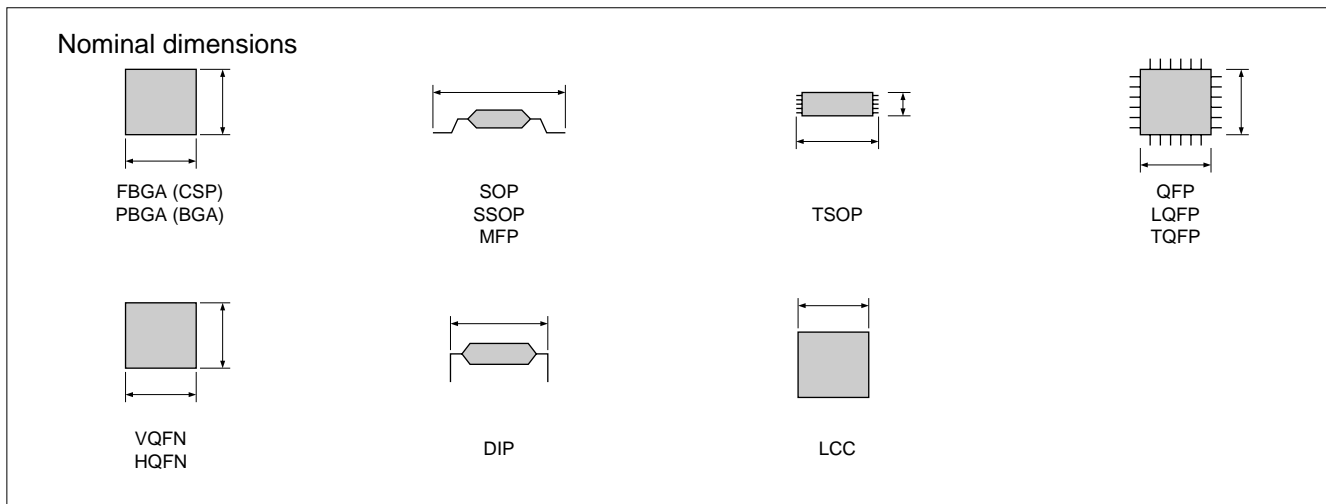

- FBGA : fine-pitch ball grid array package
- PBGA : plastic ball grid array package
- SOP : small outline package
- SSOP : shrink small outline package
- MFP : mini flat package
- TSOP : thin small outline package

- QFP : quad flat package
- LQFP : low profile quad flat package
- TQFP : thin quad flat package
- VQFN : very thin quad flat non-leaded package
- HQFN : heat sink quad flat non-leaded package
- DIP : dual in line package
- LCC : leadless chip carrier



Ball Grid Array and BGA are trademarks of Motorola Nippon Ltd.

Notice

In the absence of confirmation by device specification sheets, SHARP takes no responsibility for any defects that may occur in equipment using any SHARP devices shown in catalogs, data books, etc. Except where specially indicated, models listed on this page comply with the RoHS Directive*. For details, please contact SHARP. *RoHS Directive: Prohibits use of lead, cadmium, hexavalent chromium, mercury and specific brominated flame retardants (PBBs and PBDEs), with certain exceptions. Contact SHARP in order to obtain the latest device specification sheets before using any SHARP device.



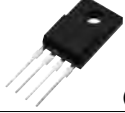
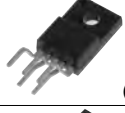



●Lead-inserting Type Packages [For regulators: PQ series]

Package type	Appearance (Package material)	No. of terminals	Terminal pitch mm	Outline dimensions (Width x Thickness x Height) mm	Lead frame material
TO-220	 (Plastic)	4	2.54	10.2 (MAX.) x 4.5 x 29.1* ²	Cu
TO-220 (Full mold)	 (Plastic)	4	2.54	10.2 (MAX.) x 4.5 x 29.1* ²	Cu
TO-220 (Full mold) [Lead forming type]	 (Plastic)	5	(1.7)* ¹	10.2 (MAX.) x 4.5 x 24.6* ²	Cu
TO-220 [Lead forming type]	 (Plastic)	5	(1.7)* ¹	10.2 (MAX.) x 4.5 x 24.6* ²	Cu
TO-220 [Lead forming type]	 (Plastic)	5	(1.7)* ¹	10.2 (MAX.) x 4.5 x 24.6* ²	Cu

*1 The figure in parentheses indicates reference value.

*2 Including lead length

●Surface-mount Type Packages [For regulators/LED drivers: PQ series]

Package type	Appearance (Package material)	No. of terminals	Terminal pitch mm	Outline dimensions (Width x Height x Thickness) mm	Lead frame material
TO-263	 (Plastic)	5 (Heat sink not included)	(1.7)* ¹	10.6 (MAX.) x 13.7 (MAX.)* ² x 3.5	Cu
SC-63	 (Plastic)	5 (Heat sink not included)	(1.27)* ¹	6.6 (MAX.) x 9.7 (MAX.)* ² x 2.3	Cu
SC-63	 (Plastic)	5 (Heat sink included)	(1.27)* ¹	6.6 (MAX.) x 9.7 (MAX.)* ² x 2.1	Cu
SOP-8	 (Plastic)	8	1.27	5 x 6.2* ² x 1.55* ²	Cu
SOT-89	 (Plastic)	6	1.5	4.5 x 4.3* ² x 1.5	Cu





*1 The figure in parentheses indicates reference value.

*2 Including lead length

Notice

In the absence of confirmation by device specification sheets, SHARP takes no responsibility for any defects that may occur in equipment using any SHARP devices shown in catalogs, data books, etc.
 Except where specially indicated, models listed on this page comply with the RoHS Directive*. For details, please contact SHARP.
 *RoHS Directive: Prohibits use of lead, cadmium, hexavalent chromium, mercury and specific brominated flame retardants (PBBs and PBDEs), with certain exceptions.
 Contact SHARP in order to obtain the latest device specification sheets before using any SHARP device.

●Surface-mount Type Packages [For regulators/LED drivers: PQ series] (cont'd)

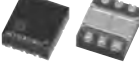
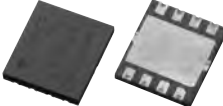
Package type	Appearance (Package material)	No. of terminals	Terminal pitch mm	Outline dimensions (Width x Height x Thickness) mm	Lead frame material
SOT-23-6	 (Plastic)	6	0.95	2.9 x 2.8* ² x 1.3	Cu
SOT-23-6W	 (Plastic)	6	0.95	2.9 x 2.8* ² x 1.3	Cu
SOT-23-L	 (Plastic)	6	(0.95)* ¹	(3.4)* ¹ x 3.3* ² x 1.4 (MAX.)	Cu
SOT-23-5	 (Plastic)	5	(0.95)* ¹	(2.9)* ¹ x 2.8* ² x 1.3 (MAX.)	Cu
USB-6		6	0.5	2.0 x 1.8 x 0.8	Cu (Terminal material)/ Au plating (Terminal finish)
USB-8		9 (Including radiating fin)	1.0	5.0 x 4.5 x 0.75 (MAX.)	Cu

*1 The figure in parentheses indicates reference value.

*2 Including lead length





Notice

In the absence of confirmation by device specification sheets, SHARP takes no responsibility for any defects that may occur in equipment using any SHARP devices shown in catalogs, data books, etc. Contact SHARP in order to obtain the latest device specification sheets before using any SHARP device.





■ Photocoupler Lineup

<Phototransistor output type>

Package type	Output type	Features	Model No. (series)	Page
Mini-flat 4-pin Compact, SMT type 	Single phototransistor	General purpose, High collector-emitter voltage, etc.	PC35x series/PC451J00000F	44
		AC input response	Low input current PC367NJ0000F	44
		High sensitivity, High collector-emitter voltage	Low input current PC354NJ0000F	44
	Darlington phototransistor	High sensitivity, High collector-emitter voltage	Low input current PC364NJ0000F	44
			PC355NJ0000F/PC452J00000F	44
			Low input current PC365NJ0000F	44
Compact, Half pitch (lead space), SMT type 	Single phototransistor	General purpose, High resistance to noise, etc.	PC3Hx series	45
		Reinforced insulation	PC3HU7xYIP0B	45
		AC input response	Low input current PC3H71xNIP0F	45
			PC3H3J00000F/PC3H4J00000F	45
	Darlington phototransistor	High sensitivity	Low input current PC3H41xNIP0F	45
			PC3H5J00000F	45
			Low input current PC3H510NIP0F	45
DIP type (4-pin) (4-pin, DIP type) 	Single phototransistor	Reinforced insulation	PC123XNNSZ0F	46
		General purpose, High collector-emitter voltage, etc.	Low input current PC1231xNSZ0X	46
			PC817XNNSZ0F/PC851XNNSZ0F	46
	Darlington phototransistor	High sensitivity, High collector-emitter voltage	Low input current PC8171xNSZ0X	46
			PC815XNNSZ0F/PC852XNNSZ0F/ PC853XNNSZ0F	46
			Low input current PC81510NSZ0X	46
DIP type (6-pin) 	Single phototransistor	General purpose, High collector-emitter voltage, etc.	PC7xxV0NSZXF	47
	Darlington phototransistor	High sensitivity, High collector-emitter voltage, etc.	PC7x5V0NSZXF	47

<OPIC output type>

Package type	Output type	Features	Model No. (series)	Page
Compact, SMT type 	Digital output	General purpose, High response speed, 2ch, etc.	PC400J00000F/PC456L0NIP0F/ PC410S0NIP0F/PC410L0NIP0F/ PC4D10SNIP0F	48
	Analog/Digital output	High CMR	PC457S0NIP0F/PC457L0NIP0F	48
DIP type, SMT type 	Digital output	General purpose	PC900V0NSZXF	49
	Built-in base amplifier	For inverter control, Built-in short-circuit protection circuit	PC925LxNSZ0F/PC942J00000F/ PC928J00000F/PC929J00000F	49



■ Photocouplers

◆ Phototransistor Output Type

<Compact, SMT type>

○: Approved

(Ta = 25°C)

Output type	Model No.	Internal connection diagram	Features	Approved by safety standards*2	Package	Absolute maximum ratings			Electro-optical characteristics						
				UL		Forward current I _F (mA)	Isolation voltage (AC) V _{iso} (rms) (kV)	Collector-emitter voltage V _{CEO} (V)	Current transfer ratio			Response time			
									CTR (%) MIN.	I _F (mA)	V _{CE} (V)	t _r (μs) TYP.	I _c (mA)	R _L (Ω)	V _{CE} (V)
Single phototransistor output	PC357NJ0000F		General purpose	○*	Mini-flat 4-pin	50	3.75	80	50	5	5	4	2	100	2
	PC352NJ0000F		General purpose, high resistance to noise*1	○		50	3.75	80	90	5	5	4	2	100	2
	PC451J0000F		High collector-emitter voltage	○*		50	3.75	350	40	5	5	4	2	100	2
	PC367NJ0000F		Low input current, high resistance to noise*1	○		10	3.75	80	100	0.5	5	4	2	100	2
	PC354NJ0000F		AC input response	○*		±50	3.75	80	20	±1	5	4	2	100	2
	PC364NJ0000F		Low input current, AC input response, high resistance to noise*1	○		±10	3.75	70	50	±0.5	5	4	2	100	2
Darlington photo-transistor output	PC355NJ0000F		High sensitivity	○*	50	3.75	35	600	1	2	60	2	100	2	
	PC365NJ0000F		High sensitivity, low input current	○	10	3.75	35	600	0.5	2	60	2	100	2	
	PC452J0000F		High collector-emitter voltage	○*	50	3.75	350	1 000	1	2	100	20	100	2	

*1 CMR: MIN.10 kV/μs

*2 Please refer to Specification Sheets for model numbers approved by safety standards.

* A VDE approved type is optionally available.



Notice

In the absence of confirmation by device specification sheets, SHARP takes no responsibility for any defects that may occur in equipment using any SHARP devices shown in catalogs, data books, etc.

Except where specially indicated, models listed on this page comply with the RoHS Directive*. For details, please contact SHARP.
*RoHS Directive: Prohibits use of lead, cadmium, hexavalent chromium, mercury and specific brominated flame retardants (PBBs and PBDEs), with certain exceptions.

Contact SHARP in order to obtain the latest device specification sheets before using any SHARP device.



◆ Phototransistor Output Type <Compact, half pitch (lead space) SMT type>

○: Approved

(Ta = 25°C)

Output type	Model No.	Internal connection diagram	Features	Approved by safety standards*3	Package	Absolute maximum ratings			Electro-optical characteristics						
				UL		Forward current I _F (mA)	Isolation voltage (AC) V _{iso} (rms) (kV)	Collector-emitter voltage V _{CEO} (V)	Current transfer ratio			Response time			
									CTR (%) MIN.	I _F (mA)	V _{CE} (V)	t _r (μs) TYP.	I _c (mA)	R _L (Ω)	V _{CE} (V)
Single phototransistor output	PC3HU7xYIP0B		Reinforced insulation (internal insulation distance: MIN. 0.4 mm), low-profile package	○*4, 5	Low-profile mini-flat 4-pin	50	3.75	80	50	5	5	4	2	100	2
	PC3H2J00000F		High resistance to noise*1	○	Mini-flat 4-pin	50	2.5	80	20	1	5	4	2	100	2
	PC3H7J00000F		Standard	○*6		50	2.5	80	20	1	5	4	2	100	2
	PC3H71xNIP0F	High resistance to noise*1, low input current	○	10		2.5	80	100	0.5	5	4	2	100	2	
	PC3H3J00000F	AC input response, high resistance to noise*1	○	±50		2.5	80	20	±1	5	4	2	100	2	
	PC3H4J00000F		AC input response	○*2, 6	±50	2.5	80	20	±1	5	4	2	100	2	
	PC3H41xNIP0F		AC input response, high resistance to noise*1, low input current	○	±10	2.5	80	50	±0.5	5	4	2	100	2	
Darlington photo-transistor output	PC3H5J00000F		High sensitivity	○	Mini-flat 4-pin	50	2.5	35	600	1	2	60	2	100	2
	PC3H510NIP0F		High sensitivity, low input current	○		10	2.5	35	600	0.5	2	60	2	100	2

*1 CMR: MIN.10 kV/μs
 *2 A VDE approved type is optionally available.
 *3 Please refer to Specification Sheets for model numbers approved by safety standards.
 *4 VDE, CSA approved
 *5 In conformance with BSI, SEMKO, DEMKO, NEMKO, and FIMKO
 *6 UL, CSA approved

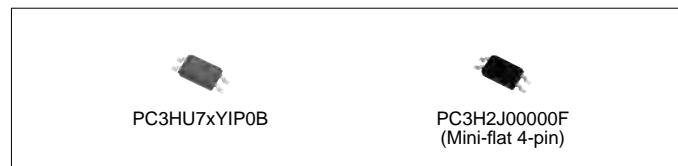

Notice

In the absence of confirmation by device specification sheets, SHARP takes no responsibility for any defects that may occur in equipment using any SHARP devices shown in catalogs, data books, etc. Except where specially indicated, models listed on this page comply with the RoHS Directive*. For details, please contact SHARP. *RoHS Directive: Prohibits use of lead, cadmium, hexavalent chromium, mercury and specific brominated flame retardants (PBBs and PBDEs), with certain exceptions. Contact SHARP in order to obtain the latest device specification sheets before using any SHARP device.



◆ Phototransistor Output Type <DIP type (4-pin)>

○: Approved

(Ta = 25°C)

Output type	Model No.	Internal connection diagram	Features	Approved by safety standards*8			Package	Absolute maximum ratings			Electro-optical characteristics			
				UL	VDE *2	Others *3		Forward current I _F (mA)	Isolation voltage (AC) V _{iso} (rms) (kV)	Collector-emitter voltage V _{CEO} (V)	CTR (%) MIN.	I _F (mA)	t _r (μs) TYP.	R _L (Ω)
Single phototransistor output	PC123XNNSZ0F*1, *5, *6, *7		High isolation voltage, reinforced insulation	○	○	○	4-pin DIP	50	5.0	70	50	5	4	100
	PC1231xNSZ0X*1		High isolation voltage, reinforced insulation, low input current, high resistance to noise*4	○	○	○		10	5.0	70	50	0.5	4	100
	PC817XNNSZ0F*5, *6, *7	High isolation voltage	○	—	○*9	50		5.0	80	50	5	4	100	
	PC8171xNSZ0X*5, *6	High isolation voltage, low input current, high resistance to noise*4	○	—	—	10		5.0	80	100	0.5	4	100	
	PC851XNNSZ0F*5, *6	High isolation voltage, high collector-emitter voltage	○	—	—	50		5.0	350	40	5	4	100	
Darlington phototransistor output	PC815XNNSZ0F*5, *6		High isolation voltage, high sensitivity	○	—	—	50	5.0	35	600	1	60	100	
	PC81510NSZ0X		High isolation voltage, high sensitivity, low input current	○	—	—	10	5.0	35	600	0.5	60	100	
	PC852XNNSZ0F*5, *6		High isolation voltage, high collector-emitter voltage	○	○	—	50	5.0	350	1 000	1	100	100	
	PC853XNNSZ0F*5, *6		High isolation voltage, high collector-emitter voltage	○	○	—	50	5.0	350	1 000	1	100	100	

*1 Wide lead spacing type is also available. Creepage distance: 6.4 mm or more, wide lead spacing type: 8 mm or more.

*2 Optionally available.

*3 BSI, SEMKO, DEMKO, NEMKO, FIMKO, CSA

*4 CMR: 10 kV/μs MIN.

*5 Lead forming type is also available for surface mounting.

*6 Taped package of lead forming type for surface mounting is also available.

*7 Wide lead spacing type is also available. Compatible with wide lead spacing type lead-forming models for surface-mount use. Also compatible with taped packages for wide lead spacing type lead-forming models for surface-mount use.

*8 Please refer to Specification Sheets for model numbers approved by safety standards.

*9 UL, CSA approved



Notice

In the absence of confirmation by device specification sheets, SHARP takes no responsibility for any defects that may occur in equipment using any SHARP devices shown in catalogs, data books, etc.

Except where specially indicated, models listed on this page comply with the RoHS Directive*. For details, please contact SHARP. *RoHS Directive: Prohibits use of lead, cadmium, hexavalent chromium, mercury and specific brominated flame retardants (PBBs and PBDEs), with certain exceptions.

Contact SHARP in order to obtain the latest device specification sheets before using any SHARP device.



◆ Phototransistor Output Type <DIP type (6-pin)>

○: Approved, △: Under application

(Ta = 25°C)

Output type	Model No.	Internal connection diagram	Features	Approved by safety standards*2		Package	Absolute maximum ratings			Electro-optical characteristics			
				UL	VDE*1		Forward current I _F (mA)	Isolation voltage (AC) V _{iso} (rms) (kV)	Collector-emitter voltage V _{CEO} (V)	Current transfer ratio		Response time	
										CTR (%) MIN.	I _F (mA)	t _r (μs) TYP.	R _L (Ω)
Single phototransistor output	PC714V0NSZXF		High isolation voltage	○	○	6-pin DIP	50	5.0	80	50	5	4	100
	PC724V0NSZXF		High isolation voltage, large input current	○	—		150	5.0	35	20	100	4	100
	PC713V0NSZXF		High isolation voltage, with base terminal	○	○		50	5.0	80	50	5	4	100
Darlington phototransistor output	PC715V0NSZXF		High isolation voltage, high sensitivity	○	○	6-pin DIP	50	5.0	35	600	1	60	100
	PC725V0NSZXF		High isolation voltage, high sensitivity, high collector-emitter voltage, high power	○	○		50	5.0	300	1 000	1	100	100

*1 Optionally available.

*2 Please refer to Specification Sheets for model numbers approved by safety standards.



Notice

In the absence of confirmation by device specification sheets, SHARP takes no responsibility for any defects that may occur in equipment using any SHARP devices shown in catalogs, data books, etc.
 Except where specially indicated, models listed on this page comply with the RoHS Directive*. For details, please contact SHARP.
 *RoHS Directive: Prohibits use of lead, cadmium, hexavalent chromium, mercury and specific brominated flame retardants (PBBs and PBDEs), with certain exceptions.
 Contact SHARP in order to obtain the latest device specification sheets before using any SHARP device.



◆ **OPIC Output** (“OPIC” (Optical IC) is a trademark of SHARP Corporation. An OPIC consists of a light-detecting element and signal-processing circuit integrated onto a single chip.)

<Compact, SMT type> (1-1)

○: Approved

(Ta = 25°C)

Model No.	Internal connection diagram	Features	Approved by safety standards*2		Package	Absolute maximum ratings		Electro-optical characteristics*1						
			UL	VDE*3		Forward current I _F (mA)	Isolation voltage (AC) V _{iso} (rms) (kV)	Low level output voltage			Threshold input current			
								V _{OL} (V) MAX.	T _a (°C)	I _{OL} (mA)	I _F (mA)	I _{FHL} (mA) MAX.	I _{FLH} (mA) MAX.	R _L (Ω)
PC400J00000F		Digital output, normal-off operation	○	—	Mini-flat 5-pin	50	3.75	0.4	0 to +70	16	4	2.0	—	280
PC456L0NIP0F		Built-in preamplifier, high speed transmission (2 Mb/s), for flow soldering	○	○		25	3.75	0.6	−40 to +85	2.4	10	5.0	—	20 k
PC410L0NIP0F		High speed (10 Mb/s), High CMR (10 kV/μs), For flow soldering	○	○		20	3.75	0.6	−40 to +85	13	5	5.0	—	350
PC410S0NIP0F		High speed (10 Mb/s), high CMR (10 kV/μs), for flow soldering, Solder heat resistance: 270°C	○	○	SOP 8-pin	20	3.75	0.6	−40 to +85	13	5	5.0	—	350
PC4D10SNIP0F		High speed (10 Mb/s), for flow soldering, Solder heat resistance: 270°C 2ch output	○	—	SOP 8-pin	20	3.75	0.6	−40 to +85	13	5	5.0	—	350

A: Rated voltage circuit

*1 Each item is measured at V_{CC}=5V. (PC400)

*2 Please refer to Specification Sheets for model numbers approved by safety standards.

*3 Optionally available.

<Compact, SMT type> (1-2)

○: Approved

(Ta = 25°C)

Model No.	Internal connection diagram	Features	Approved by safety standards*1		Package	Absolute maximum ratings		Electro-optical characteristics							
			UL	VDE*2		Forward current I _F (mA)	Isolation voltage (AC) V _{iso} (rms) (kV)	Current transfer ratio			Propagation delay time				
								CTR (%) MIN.	I _F (mA)	V _O (V)	V _{CC} (V)	t _{PHL} (μs) TYP.	t _{PLH} (μs) TYP.	R _L (Ω)	I _F (mA)
PC457L0NIP0F		High speed (1 Mb/s), high CMR (15 kV/μs), for flow soldering	○	○	Mini-flat 5-pin	25	3.75	19	16	0.4	4.5	0.2	0.4	1 900	16
PC457S0NIP0F		High speed (1 Mb/s), high CMR (15 kV/μs), for flow soldering, Solder heat resistance: 270°C	○	○	SOP 8-pin	25	3.75	19	16	0.4	4.5	0.2	0.3	1 900	16

*1 Please refer to Specification Sheets for model numbers approved by safety standards.

*2 Optionally available.

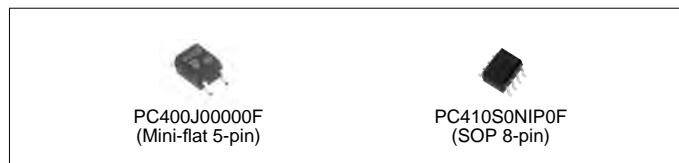

PC400J00000F
(Mini-flat 5-pin)

PC410S0NIP0F
(SOP 8-pin)

Notice

In the absence of confirmation by device specification sheets, SHARP takes no responsibility for any defects that may occur in equipment using any SHARP devices shown in catalogs, data books, etc.

Except where specially indicated, models listed on this page comply with the RoHS Directive*. For details, please contact SHARP.
*RoHS Directive: Prohibits use of lead, cadmium, hexavalent chromium, mercury and specific brominated flame retardants (PBBs and PBDEs), with certain exceptions.

Contact SHARP in order to obtain the latest device specification sheets before using any SHARP device.



◆ **OPIC Output** (“OPIC” (Optical IC) is a trademark of SHARP Corporation. An OPIC consists of a light-detecting element and signal-processing circuit integrated onto a single chip.)

<DIP type, digital output>

○: Approved

(Ta = 25°C)

Model No.	Internal connection diagram	Features	Approved by safety standards*5		Package	Absolute maximum ratings		Electro-optical characteristics*1						
			UL	VDE *4		Forward current IF (mA)	Isolation voltage (AC) Viso (rms) (kV)	Low level output voltage			Threshold input current			
								VOL (V) MAX.	Ta (°C)	IoL (mA)	IF (mA)	IFHL (mA) MAX.	IFLH (mA) MAX.	RL (Ω)
PC900V0NSZXF*2, *3		Digital output, normal-off operation	○	○	6-pin DIP	50	5.0	0.4	0 to +70	16	4	2.0	–	280

A: Rated voltage circuit

*1 Each item is measured at Vcc=5V.

*2 Lead forming type is also available for surface mounting.

*3 Taped package of lead forming type for surface mounting is also available.

*4 Optionally available.

*5 Please refer to Specification Sheets for model numbers approved by safety standards.

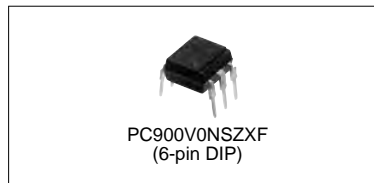

◆ **OPIC Output** (“OPIC” (Optical IC) is a trademark of SHARP Corporation. An OPIC consists of a light-detecting element and signal-processing circuit integrated onto a single chip.)

<DIP type, Gate drive type>

○: Approved

(Ta = 25°C)

Model No.	Internal connection diagram	Features	Approved by safety standards*3		Package	Absolute maximum ratings		Electro-optical characteristics					
			UL	VDE *2		Forward current IF (mA)	Isolation voltage (AC) Viso (rms) (kV)	Propagation delay time				RL1 (Ω)	RL2 (Ω)
								tPHL (μs) TYP.	tPLH (μs) TYP.	VCC (V)	IF (mA)		
PC925LxNSZ0F*1		<ul style="list-style-type: none"> Built-in drive circuit directly connectable to MOS-FET and IGBT Peak output current: 2.5 A Low dissipation current (Icc = TYP. 2.5 mA) High resistance to noise (CMR: MIN. 15 kV/μs) 	○	○	8-pin DIP	25	5.0	MAX.	MAX.	15 to 30	7 to 16	RG = 10	–
PC942J00000F		For controlling inverter-controlled air-conditioner	○	○				25	5.0	2.0	2.0	6	5
PC928J00000F		For driving inverter IGBT, built-in short protection circuit	○	○	14-pin SMT (Half pitch lead)	25	4.0	1.0	1.0	24	10	RG = 47	–
PC929J00000F		For driving inverter IGBT, high speed, built-in short protection circuit	○	○				20	4.0	0.3	0.3	24	5

*1 Lead forming type is also available for surface mounting. Taped package of lead forming type for surface mounting is also available.

*2 A VDE approved type is optionally available.

*3 Please refer to Specification Sheets for model numbers approved by safety standards.

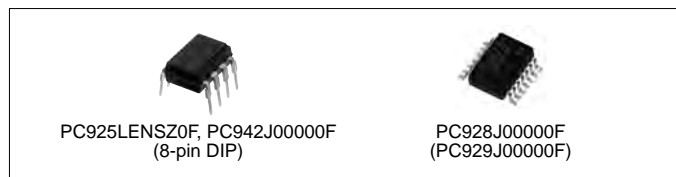



Notice

In the absence of confirmation by device specification sheets, SHARP takes no responsibility for any defects that may occur in equipment using any SHARP devices shown in catalogs, data books, etc. Except where specially indicated, models listed on this page comply with the RoHS Directive*. For details, please contact SHARP. *RoHS Directive: Prohibits use of lead, cadmium, hexavalent chromium, mercury and specific brominated flame retardants (PBBs and PBDEs), with certain exceptions. Contact SHARP in order to obtain the latest device specification sheets before using any SHARP device.



■ Phototriac Coupler Lineup

Package	Applied voltage	ON-state current (rms)	Features	Model No.	Page	
Mini-flat (SMD) 	AC 200 V lines (V _{DRM} = 600V)	0.05 A	General purpose	S2S3000F*3 / S2S5A00F*3	51	
			Built-in zero-cross circuit	S2S4000F*3	52	
DIP type (4-pin) 	AC 200 V lines (V _{DRM} = 600V)	0.1 A	General purpose	PC3ST11NSZAX*3	51	
			Built-in zero-cross circuit	PC3ST21NSZBX*2	52	
			Reinforced isolation	PC3SH11YFZAX*3 / PC3SH13YFZAX*3	51	
			Built-in zero-cross circuit	PC3SH21YFZBX*2	52	
DIP type (6-pin package, 5th-pin cut) 	AC 100 V lines (V _{DRM} = 400V)	0.1 A	General purpose	PC2SD11NTZAF*3	51	
			AC 200 V lines (V _{DRM} = 600V)	0.1 A	General purpose	PC3SD12NTZAF*3 / PC3SD12NTZBF*2 / PC3SD11NTZCF*1
	Built-in zero-cross circuit	PC3SD21NTZAF*3 / PC3SD21NTZBF*2 / PC3SD21NTZCF*1 / PC3SD21NTZDF / PC3SD23YTZCF*1			52	
	Reinforced isolation	PC3SF11YVZAF*3 / PC3SF11YVZBF*2 / PC3SF13YVZBF*2		51		
	Built-in zero-cross circuit	PC3SF21YVZAF*3 / PC3SF21YVZBF*2		52		
	AC 200 V lines (V _{DRM} = 800V)	0.1 A		General purpose	PC4SD11NTZBF*2 / PC4SD11NTZCF*1	51
				Built-in zero-cross circuit	PC4SD21NTZCF*1 / PC4SD21NTZDF	52
				Reinforced isolation	PC4SF11YVZAF*3 / PC4SF11YVZBF*2	51
				Built-in zero-cross circuit	PC4SF21YVZBF*2 / PC4SF21YVZCF*1	52

Minimum trigger current: *1 I_{FT} ≦ 5 mA, *2 I_{FT} ≦ 7 mA, *3 I_{FT} ≦ 10 mA



■ Phototriac Couplers

○: Approved

(Ta = 25°C)

Model No.	Internal connection diagram	Features	Approved by safety standards*4			Package	Absolute maximum ratings			Electro-optical characteristics	
			UL, CSA	VDE	Others		ON-state current I _T (rms) (A)	Repetitive peak OFF-state voltage V _{DRM} (V)	Isolation voltage (AC) V _{iso} (rms) (kV)		Min. trigger current I _{FT} (mA) MAX. V _D = 6 V, R _L = 100Ω
S2S3000F		200 V lines, compact	○	○*6	—	Mini-flat 4-pin	0.05	600	3.75	10	
S2S5A00F		200 V lines, compact	○	○*6	—					10	
PC3ST11NSZAX		200 V lines, compact	○	○*6	—	4-pin DIP	0.1	600	5.0	10	
PC3SH11YFZAX		200 V lines, compact, reinforced isolation	○	○	○*2					10	
PC3SH13YFZAX		200 V lines, compact, reinforced isolation, high noise resistance	○	○	○*2					10	
PC2SD11NTZAF*7		100 V lines	○	—	—	6-pin DIP*1, 3	0.1	400	5.0	10	
PC3SD12NTZAF*8		200 V lines	○	○*6	—					600	10
PC3SD12NTZBF		200 V lines	○	○*6	—					800	7
PC4SD11NTZBF		200 V lines, repetitive peak-OFF-state voltage	○	○*6	—					600	7
PC3SD11NTZCF		200 V lines	○	○*6	—					800	5
PC4SD11NTZCF		200 V lines, repetitive peak-OFF-state voltage	○	○*6	—					600	5
PC3SF11YVZAF		200 V lines, reinforced isolation	○	○	○*2					800	10
PC3SF11YVZBF		200 V lines, reinforced isolation	○	○	○*2					600	7
PC3SF13YVZBF		200 V lines, reinforced isolation, high noise resistance	○	○	○*2					800	7
PC4SF11YVZAF		200 V lines, reinforced isolation, repetitive peak-OFF-state voltage	○	○	○*2					600	10
PC4SF11YVZBF		200 V lines, reinforced isolation, repetitive peak-OFF-state voltage	○	○	○*2					800	7

For the notes *1 to *9, see next page.

Notice

In the absence of confirmation by device specification sheets, SHARP takes no responsibility for any defects that may occur in equipment using any SHARP devices shown in catalogs, data books, etc. Except where specially indicated, models listed on this page comply with the RoHS Directive*. For details, please contact SHARP. *RoHS Directive: Prohibits use of lead, cadmium, hexavalent chromium, mercury and specific brominated flame retardants (PBBs and PBDEs), with certain exceptions. Contact SHARP in order to obtain the latest device specification sheets before using any SHARP device.



Phototriac Couplers (Built-in zero-cross circuit type)

○: Approved

(Ta = 25°C)

Model No.	Internal connection diagram	Features	Approved by safety standards*4			Package	Absolute maximum ratings			Electro-optical characteristics
			UL, CSA	VDE	Others		ON-state current I _T (rms) (A)	Repetitive peak OFF-state V _{DRM} (V)	Isolation voltage (AC) V _{iso} (rms) (kV)	
S2S4000F		200 V lines, compact	○	○*6	—	Mini-flat 4-pin	0.05	600	3.75	10*5
PC3ST21NSZBX		200 V lines, compact	○	○*6	—	4-pin DIP	0.1	600	5.0	7
PC3SH21YFZBX		200 V lines, compact, reinforced isolation	○	○	○*2					7
PC3SD21NTZAF		200 V lines, low zero-cross voltage: MAX. 20 V	○	○*6	—	6-pin DIP*1,3	0.1	600	5.0	10
PC3SD21NTZBF		200 V lines, low zero-cross voltage: MAX. 20 V	○	○*6	—					7
PC3SD21NTZCF*9		200 V lines, low zero-cross voltage: MAX. 20 V	○	○*6	—					5
PC3SD23YTZCF		200 V lines, high pulse/noise resistance (TYP. 2 kV)	○	○	—					5
PC3SD21NTZDF		200 V lines, low zero-cross voltage: MAX. 20 V	○	○*6	—					3
PC4SD21NTZCF		200 V lines, repetitive peak-OFF-state voltage	○	○*6	—					5
PC4SD21NTZDF		200 V lines, repetitive peak-OFF-state voltage	○	○*6	—					3
PC3SF21YVZAF		200 V lines, reinforced isolation	○	○	○*2					10
PC3SF21YVZBF		200 V lines, reinforced isolation	○	○	○*2					7
PC4SF21YVZBF		200 V lines, reinforced isolation, repetitive peak-OFF-state voltage	○	○	○*2					7
PC4SF21YVZCF		200 V lines, reinforced isolation, repetitive peak-OFF-state voltage	○	○	○*2					5

*1 Lead forming type for surface mounting is also available.
 *2 In conformance with BSI, SEMKO, DEMKO, and FIMKO
 *3 These are molded pin No. 5.
 *4 Please refer to Specification Sheets for model numbers approved by safety standards.
 *5 V_D = 6 V, R_L = 100Ω
 *6 Optionally available
 *7 An equivalent model (I_{FT} MAX.: 15 mA) with overseas brand compatibility is also available. (PC1S3021NTZF)
 *8 An equivalent model with overseas brand compatibility is also available. (PC1S3052NTZF)
 *9 An equivalent model with overseas brand compatibility is also available. (PC1S3063NTZF)

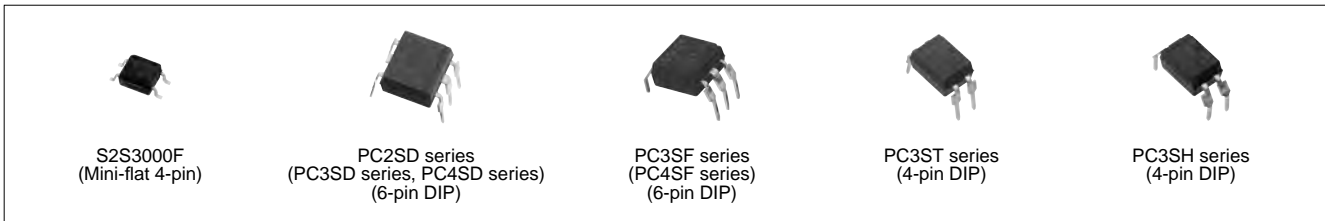





Notice

In the absence of confirmation by device specification sheets, SHARP takes no responsibility for any defects that may occur in equipment using any SHARP devices shown in catalogs, data books, etc. Except where specially indicated, models listed on this page comply with the RoHS Directive*. For details, please contact SHARP. *RoHS Directive: Prohibits use of lead, cadmium, hexavalent chromium, mercury and specific brominated flame retardants (PBBs and PBDEs), with certain exceptions. Contact SHARP in order to obtain the latest device specification sheets before using any SHARP device.



■ Solid State Relay Lineup

Package	Applied voltage	ON-state current (rms)	Features	Model No.	Page
DIP 6-pin 	AC 100 V lines	0.06 A	General purpose	PR22MA11NTZF	54
	AC 200 V lines	0.15 A	General purpose	PR31MA11NTZF / PR32MA11NTZF	54
DIP 8-pin 	AC 100 V lines	0.3/0.6/0.9 A	General purpose	PR23MF11NSZF / PR26MF series / PR29MF series	54
		0.6/0.9 A	Built-in zero-cross circuit	PR26MF21NSZF / PR29MF21NSZF	54
	AC 200 V lines	0.3/0.6/0.9/1.2 A	General purpose	PR33MF51NSZF / PR36MF series / PR39MF series / PR3BMF51NSKF	54
		0.6/0.9/1.2 A	Built-in zero-cross circuit	PR36MF2 series / PR39MF2 series / PR3BMF21NSZF	54
SIP 4-pin  Low profile 	AC 100 V lines	2/8 A 3 to 16 A	General purpose	S102T01F*1 / S108T01F*1 / S101S05F / S102S01F / S112S01F / S116S01F	55
		2/8 A 3 to 16 A	Built-in zero-cross circuit	S102T02F*1 / S108T02F*1 / S101S06F / S102S02F / S116S02F	55
		8 A	Built-in snubber circuit	S102S11F	55
		3/8 A	Built-in snubber circuit/ zero-cross circuit	S101S16F / S102S12F	55
	AC 200 V lines	General purpose		S202T01F*1 / S208T01F*1 / S202S01F / S212S01F / S216S01F	55
		2/8 A 3 to 16 A	Built-in zero-cross circuit	S202T02F*1 / S208T02F*1 / S201S06F / S202S02F / S216S02F	55/56
		8/8 A	Built-in snubber circuit	S202S15F / S202S11F	56
		8 A	Built-in snubber circuit/ zero-cross circuit	S202S12F	56

*1 Low profile



Solid State Relays

<DIP type>

○: Approved

(Ta = 25°C)

Model No.	Internal connection diagram	Features	Approved by safety standards*1			Package	Absolute maximum ratings			Electrical characteristics	
			UL	CSA	VDE*2		ON-state current I _T (rms) (A)	Repetitive peak OFF-state voltage V _{DRM} (V)	Isolation voltage (AC) V _{iso} (rms) (kV)		
PR31MA11NTZF		200 V lines, compact	○	○	○	6-pin DIP	0.06	600	5.0	10	
PR22MA11NTZF		100 V lines, 150 mA model in a small package	○	○	○		0.15	400		10	
PR32MA11NTZF		200 V lines, 150 mA model in a small package	○	○	○		0.15	600		10	
PR23MF11NSZF		100 V lines, compact	○	○	—	8-pin DIP	0.3	400	4.0	10	
PR33MF51NSZF		200 V lines, compact	○	○	○			600		10	
PR26MF11NSZF		100 V lines, compact	○	○	—		0.6	400		10	
PR26MF12NSZF		100 V lines, compact, low input current	○	○	—					5	
PR29MF11NSZF		100 V lines, compact	○	○	—		0.9	400		10	
PR29MF12NSZF		100 V lines, compact, low input current	○	○	—					5	
PR36MF51NSZF		200 V lines, compact	○	○	○		0.6	600		10	
PR36MF12NSZF		200 V lines, compact, low input current	○	○	○					5	
PR39MF12NSZF		200 V lines, compact, low input current	○	○	○		0.9	600		5	
PR39MF51NSZF		200 V lines, compact	○	○	○					10	
PR3BMF51NSKF		200 V lines, compact	○	○	○		1.2	600		10	
PR26MF21NSZF			100 V lines, compact (built-in zero-cross circuit)	○	○		—	0.6		400	10
PR29MF21NSZF			100 V lines, compact (built-in zero-cross circuit)	○	○		—				0.9
PR36MF22NSZF			200 V lines, compact (built-in zero-cross circuit), low input current	○	○		○	0.6		600	5
PR39MF22NSZF	200 V lines, compact (built-in zero-cross circuit), low input current		○	○	○	0.9	5				
PR36MF21NSZF	200 V lines, compact (built-in zero-cross circuit)		○	○	○	0.6	600	10			
PR39MF21NSZF	200 V lines, compact (built-in zero-cross circuit)		○	○	○			0.9	10		
PR3BMF21NSZF	200 V lines, compact (built-in zero-cross circuit)		○	○	○	1.2	600	10			

*1 Please refer to Specification Sheets for model numbers approved by safety standards.

*2 Optionally available.

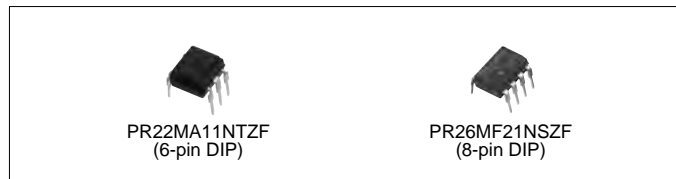

PR22MA11NTZF
(6-pin DIP)

PR26MF21NSZF
(8-pin DIP)

Notice

In the absence of confirmation by device specification sheets, SHARP takes no responsibility for any defects that may occur in equipment using any SHARP devices shown in catalogs, data books, etc. Except where specially indicated, models listed on this page comply with the RoHS Directive*. For details, please contact SHARP. *RoHS Directive: Prohibits use of lead, cadmium, hexavalent chromium, mercury and specific brominated flame retardants (PBBs and PBDEs), with certain exceptions. Contact SHARP in order to obtain the latest device specification sheets before using any SHARP device.



<SIP type> (1)

○: Approved, △: Under application

(Ta = 25°C)

Model No.	Internal connection diagram	Features	Approved by safety standards*6		Package	Absolute maximum ratings			Electrical characteristics			
			UL	CSA		ON-state current I _T (rms) (A)	Repetitive peak OFF-state voltage V _{DRM} (V)	Isolation voltage (AC) V _{iso} (rms) (kV)	Min. trigger current I _{FT} (mA) MAX.	V _D (V)	R _L (Ω)	
S102T01F		100 V lines, low profile	○	○	Low profile 4-pin SIP	2	3.0	3.0	8	12	30	
S108T01F		100 V lines, low profile	-	-		8*2			8	12	30	
S102T02F		100 V lines, low profile (built-in zero-cross circuit)	○	○	4-pin SIP	2	400	4.0	8	12	30	
S108T02F		100 V lines, low profile (built-in zero-cross circuit)	-	-		8*2			8	12	30	
S101S05F		100 V lines	○	○	4-pin SIP	3*3	400	4.0	15	12	30	
S102S01F		100 V lines	○	○		8*2			8	12	30	
S112S01F		100 V lines	○	○		12*4			8	12	30	
S116S01F		100 V lines	○	○		16*5			8	12	30	
S101S06F		100 V lines (built-in zero-cross circuit)	○	○	4-pin SIP	3*3	400	3.0	15	6	30	
S102S02F		100 V lines (built-in zero-cross circuit)	○	○		8*2			8	6	30	
S116S02F		100 V lines (built-in zero-cross circuit)	○	○		16*5			8	6	30	
S102S11F		100 V lines (built-in snubber circuit)	○	○	4-pin SIP	8*1	400	4.0	8	12	30	
S101S16F		100 V lines (built-in snubber circuit, built-in zero-cross circuit)	○	○		3*3			3.0	15	6	30
S102S12F		100 V lines (built-in snubber circuit, built-in zero-cross circuit)	○	○		8*1			4.0	8	6	30
S202T01F		200 V lines, low profile	○	○		Low profile 4-pin SIP			2	600	3.0	8
S208T01F		200 V lines, low profile	-	-	8*2		8	12	30			
S202T02F		200 V lines, low profile (built-in zero-cross circuit)	○	○	4-pin SIP	2	600	4.0	8	12	30	
S208T02F		200 V lines, low profile (built-in zero-cross circuit)	-	-		8*2			8	12	30	
S202S01F		200 V lines	○	○	4-pin SIP	8*2	600	4.0	8	12	30	
S212S01F		200 V lines	-	-		12*4			8	12	30	
S216S01F		200 V lines	-	-		16*5			8	12	30	

For the notes *1 to *6, see next page.

Notice

In the absence of confirmation by device specification sheets, SHARP takes no responsibility for any defects that may occur in equipment using any SHARP devices shown in catalogs, data books, etc. Except where specially indicated, models listed on this page comply with the RoHS Directive*. For details, please contact SHARP. *RoHS Directive: Prohibits use of lead, cadmium, hexavalent chromium, mercury and specific brominated flame retardants (PBBs and PBDEs), with certain exceptions. Contact SHARP in order to obtain the latest device specification sheets before using any SHARP device.



<SIP type> (2)

○: Approved, △: Under application

(Ta = 25°C)

Model No.	Internal connection diagram	Features	Approved by safety standards*6		Package	Absolute maximum ratings			Electrical characteristics		
			UL	CSA		ON-state current I _T (rms) (A)	Repetitive peak OFF-state voltage V _{DRM} (V)	Isolation voltage (AC) V _{iso} (rms) (kV)	Min. trigger current I _{FT} (mA) MAX.	V _D (V)	R _L (Ω)
S201S06F		200 V lines (built-in zero-cross circuit)	○	○	4-pin SIP	3*3	600	3.0	15	6	30
S202S02F		200 V lines (built-in zero-cross circuit)	○	○		8*2			4.0	8	6
S216S02F		200 V lines (built-in zero-cross circuit)	—	—		16*5		8		6	30
S202S15F		200 V lines (built-in snubber circuit)	—	—		8*2		3.0	15	12	30
S202S11F		200 V lines (built-in snubber circuit)	○	○		8*1			8	12	30
S202S12F		200 V lines (built-in snubber circuit, built-in zero-cross circuit)	○	○		8*1		4.0	8	6	30

*1 T_c ≤ 88°C

*2 T_c ≤ 80°C

*3 T_c ≤ 100°C

*4 T_c ≤ 70°C

*5 T_c ≤ 60°C

*6 Please refer to Specification Sheets for model numbers approved by safety standards.

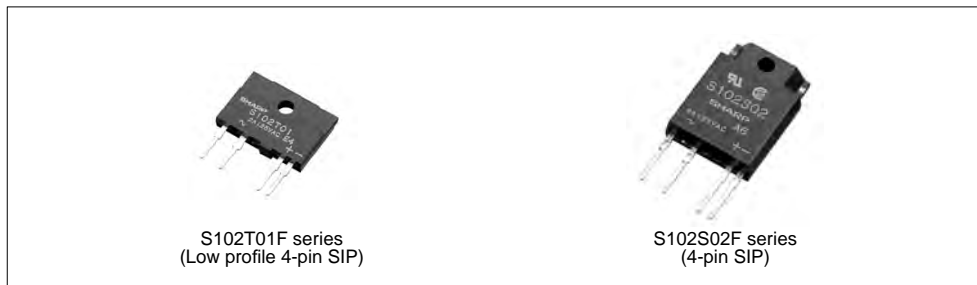

Notice

In the absence of confirmation by device specification sheets, SHARP takes no responsibility for any defects that may occur in equipment using any SHARP devices shown in catalogs, data books, etc. Except where specially indicated, models listed on this page comply with the RoHS Directive*. For details, please contact SHARP. *RoHS Directive: Prohibits use of lead, cadmium, hexavalent chromium, mercury and specific brominated flame retardants (PBBs and PBDEs), with certain exceptions. Contact SHARP in order to obtain the latest device specification sheets before using any SHARP device.



■ Photointerrupter Lineup

<Transmissive type>

Output type	Package type	Outline	Mounting method	Model No. (series)	Page
Single phototransistor	Compact	High resolution	PWB mounting type	GP1S396HCP0F/GP1S09xHCZ0F/ GP1S19xHCZ0F	58
High response speed	Case type	High resolution	Surface-mount type/ Soldering reflow	GP1S396HCPSF/GP1S296HCPSF/ GP1S092HCPIF/GP1S19xHCxSF	58
			PWB mounting type, etc.	GP1S5x series	59
		Horizontal slit, High resolution	PWB mounting type	GP1S59J0000F	59
	With connector	General purpose	Snap-in	GP1S173LCS2F/GP1S74PJ000F/ GP1S273LCS1F	59
Darlington phototransistor	Case type	General purpose	PWB mounting type, etc.	GP1L5x series	60
High sensitivity		Wide gap	PWB mounting type	GP1L57J0000F	60
Digital output	Compact	High voltage	PWB mounting type	GP1A98HCZ0F	60
(OPIC output)			Surface-mount type	GP1A98HCPSF	60
	Case type	High resolution	With screw hole/ PWB mounting type	GP1A5x series	61
		Wide gap	PWB mounting type	GP1A57HRJ00F	61
	With connector	General purpose	Screw mounting type/Snap-in	GP1A173LCS2F/GP1A173LCSVF/ GP1A273LCS1F/GP1A7x series/ GP1A07x series	62

<Reflective type>

Output type	Package type	Outline	Mounting method	Model No. (series)	Page
Single phototransistor	Leadless	Long focal distance	Surface-mount type	GP2S700HCP	62
High response speed	Compact, thin (leadless)	General purpose	Surface-mount type	GP2S60	62
OPIC output	With connector	Light modulation type, Sensitivity adjusted	Screw mounting type/ Compact snap-in/ Inverter light countermeasures	GP2A25 series/GP2A28 series/ GP2A200LCS0F/GP2A230LRS0F/ GP2A231LRS0F/ GP2A240LCS0F/GP2A250LCS0F	63

<Application-specific photointerrupter lineup>

Detection type	Outline (Output type etc.)	Mounting method	Model No. (series)	Page	
Transmissive type	Case type With encoder function Digital 2 output (phase A/B)	Resolution: 45 LPI Linear scale slit pitch: 0.56 mm	PWB mounting type	GP1A057SGKLF	64
		Resolution: 150 LPI Linear scale slit pitch: 0.17 mm	PWB mounting type/	GP1A057RBKLF	64
		Resolution: 180 LPI Linear scale slit pitch: 0.14 mm	Screw mounting type	GP1A058SCK0F	64
		Resolution: 300 LPI Linear scale slit pitch: 0.0847 mm	PWB mounting type	GP1A054RDKLF	64
		Case type With encoder function Digital 2 output (Multiplying output)	Resolution for reading: 180 LPI Pitch: 0.14 mm Output resolution: 360 LPI	PWB mounting type	GP1A101C2KSF
	For amusement use		Screw mounting	GP1A204HCS0	64
Reflective type	Injection For prism system (Single phototransistor)		Screw mounting	GP2S29SVJ00F	64
	For amusement use (Pachinko ball sensor)		–	GP2A222HCKA	65

■ Photointerrupters

<Transmissive type>

◆ Single phototransistor output

<Compact type>

(Ta = 25°C)

Model No.	Internal connection diagram	Features	Detecting and emitting gap (mm)	Slit width (mm)	Electro-optical characteristics						
					Current transfer ratio			Response time			
					CTR (%) MIN.	If (mA)	VCE (V)	tr (μs) TYP.	Ic (mA)	RL (kΩ)	VCE (V)
GP1S092HCPIF		Wide gap, for soldering reflow, surface mount compatible, with positioning boss (4.5 × 2.6 × 2.9 [height] mm)	2.0	0.3	2.0	5	5	50	0.1	1	5
GP1S093HCZ0F		Wide gap (4.5 × 2.6 × 2.9 [height] mm)	2.0	0.3	2.0	5	5	50	0.1	1	5
GP1S094HCZ0F		Wide gap, with positioning pin, (5.5 × 2.6 × 4.8 [height] mm)	3.0	0.3	0.8	5	5	50	0.1	1	5
GP1S096HCZ0F		Narrow gap (3.5 × 2.6 × 2.9 [height] mm)	1.0	0.3	2.0	5	5	50	0.1	1	5
GP1S194HCZ0F		Compact, wide gap, size: 3.6 × 2.0 × 2.7 (height) mm	1.7	0.3	3.0	5	5	50	0.1	1	5
GP1S195HCZSF GP1S195HCPSF		Compact, wide gap, surface mount compatible, size: 3.4 × 2.0 × 2.7 (height) mm	1.5	0.3	3.0	5	5	50	0.1	1	5
GP1S196HCZ0F		Compact, low profile (3.1 × 2.0 × 2.7 [height] mm)	1.1	0.3	2.0	5	5	50	0.1	1	5
GP1S196HCZSF GP1S196HCPSF		Surface mount, for soldering reflow, compact, low profile (3.1 × 2.0 × 2.7 [height] mm)	1.1	0.3	2.0	5	5	50	0.1	1	5
GP1S296HCPSF		Surface mount, for soldering reflow, compact, low profile (2.5 × 1.8 × 1.9 [height] mm)	1.0	0.2	3.0	5	5	50	0.1	1	5
☆GP1S396HCP0F		Straight lead type, compact, low profile (2.26 × 1.4 × 1.6 [height] mm)	1.2	0.12	2.0	5	5	50	0.1	1	5
☆GP1S396HCPSF		Surface mount, for soldering reflow, compact, low profile (2.26 × 1.4 × 1.6 [height] mm)	1.2	0.12	2.0	5	5	50	0.1	1	5
GP1S097HCZ0F		High resolution, wide gap, with mounting hole (4.5 × 2.6 × 4.5 [height] mm)	2.0	0.3	2.0	5	5	50	0.1	1	5

* Top: -25 to +85°C

** GP1SxxxHCZxF: Sleeve package, GP1SxxxHCPxF: Taped package

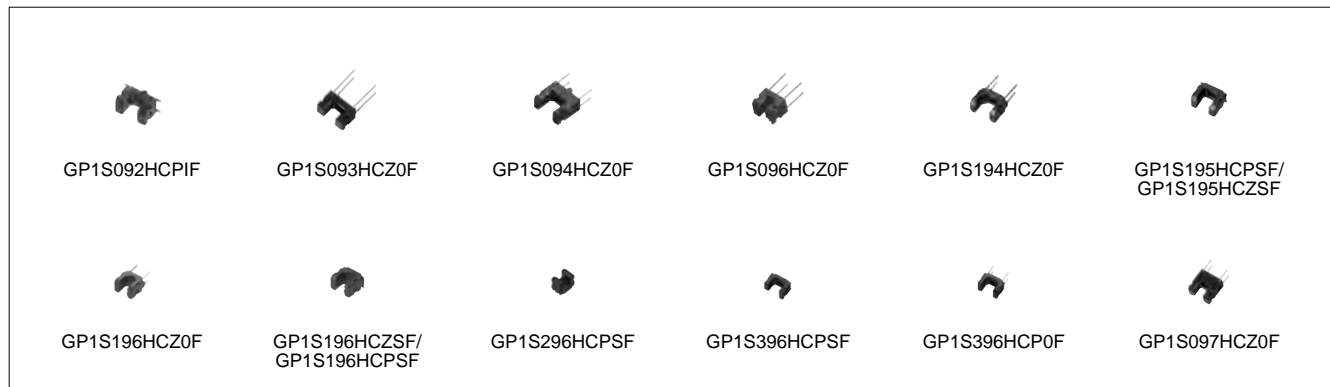

Notice

In the absence of confirmation by device specification sheets, SHARP takes no responsibility for any defects that may occur in equipment using any SHARP devices shown in catalogs, data books, etc.
 Except where specially indicated, models listed on this page comply with the RoHS Directive*. For details, please contact SHARP.
 *RoHS Directive: Prohibits use of lead, cadmium, hexavalent chromium, mercury and specific brominated flame retardants (PBBs and PBDEs), with certain exceptions.
 Contact SHARP in order to obtain the latest device specification sheets before using any SHARP device.



<Case type>

(Ta = 25°C)

Model No.	Internal connection diagram	Features	Detecting and emitting gap (mm)	Slit width (mm)	Electro-optical characteristics						
					Current transfer ratio			Response time			
					CTR (%) MIN.	IF (mA)	VCE (V)	tr (μs) TYP.	IC (mA)	RL (Ω)	VCE (V)
GP1S50J000F		High resolution, both-side mounting type	3.0	0.5	2.5	20	5	3	2	100	2
GP1S51VJ000F		High resolution, side mounting type	3.0	0.5	2.5	20	5	3	2	100	2
GP1S52VJ000F		High resolution, PWB mounting type	3.0	0.5	2.5	20	5	3	2	100	2
GP1S53VJ000F		High resolution, PWB mounting type	5.0	0.5	2.5	20	5	3	2	100	2
GP1S54J0000F		High resolution, with positioning pin, PWB mounting type	3.0	0.5	2.5	20	5	3	2	100	2
GP1S56TJ000F		High resolution, with positioning pin, PWB mounting type	2.0	0.15	2.0	20	5	38	0.5	1 000	2
GP1S58VJ000F		High resolution, with positioning pin, PWB mounting type	5.0	0.5	2.5	20	5	3	2	100	2
GP1S59J0000F		High resolution, horizontal slit, with positioning pin, PWB mounting type	4.2	0.5	2.5	20	5	3	2	100	2

* Topr: -25 to +85°C

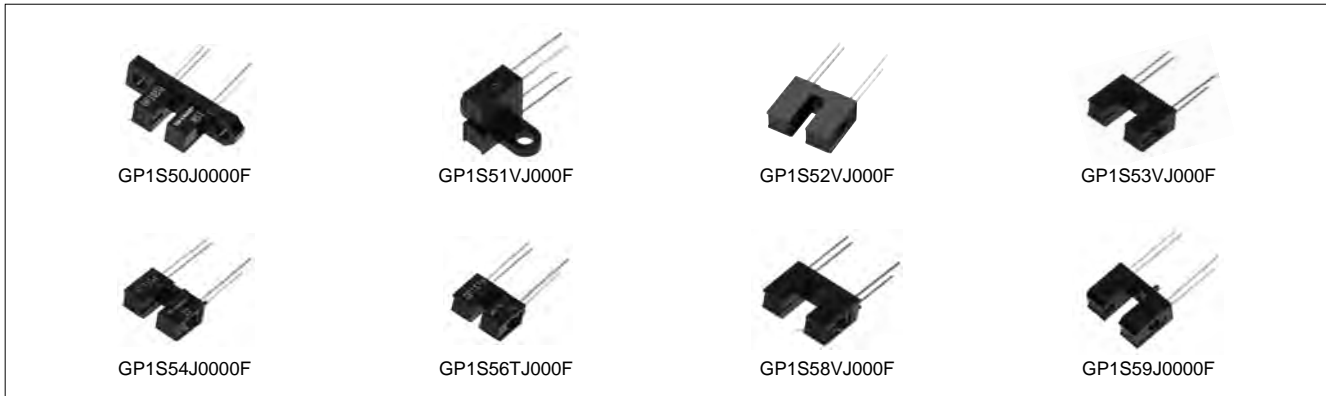

<With connector>

(Ta = 25°C)

Model No.	Internal connection diagram	Features	Detecting and emitting gap (mm)	Slit width (mm)	Electro-optical characteristics						
					Current transfer ratio			Response time			
					CTR (%) MIN.	IF (mA)	VCE (V)	tr (μs) TYP.	IC (mA)	RL (Ω)	VCE (V)
GP1S74PJ000F		Snap-in mounting type with connector Applicable to 3 kinds of thickness of mounting boards	5.0	0.5	2.5	20	5	3	2	100	2
GP1S173LCS2F		Snap-in mounting integrated connector type Applicable to 3 kinds of thickness of mounting boards	5.0	0.5	2.5	20	5	3	2	100	2
GP1S273LCS1F		Snap-in mounting integrated connector type Applicable to 3 kinds of thickness of mounting boards Compact (Compatible with 1.5 mm pitch connector)	5.0	0.7	2.5	20	5	3	2	100	2

* Topr: -25 to +85°C, -30 to +95°C (GP1S173LCS2F, GP1S273LCS1F)



Notice

In the absence of confirmation by device specification sheets, SHARP takes no responsibility for any defects that may occur in equipment using any SHARP devices shown in catalogs, data books, etc.
 Except where specially indicated, models listed on this page comply with the RoHS Directive*. For details, please contact SHARP.
 *RoHS Directive: Prohibits use of lead, cadmium, hexavalent chromium, mercury and specific brominated flame retardants (PBBs and PBDEs), with certain exceptions.
 Contact SHARP in order to obtain the latest device specification sheets before using any SHARP device.



◆Darlington phototransistor output

<Case type>

(Ta = 25°C)

Model No.	Internal connection diagram	Features	Detecting and emitting gap (mm)	Slit width (mm)	Electro-optical characteristics						
					Current transfer ratio			Response time			
					CTR (%) MIN.	IF (mA)	VCE (V)	tr (μs) TYP.	IC (mA)	RL (Ω)	VCE (V)
GP1L50J0000F▲		High sensitivity, both-side mounting type	3.0	0.5	50	1	2	80	2	100	2
GP1L51J0000F		High sensitivity, side mounting type	3.0	0.5	50	1	2	80	2	100	2
GP1L52VJ000F		High sensitivity, PWB mounting type	3.0	0.5	50	1	2	80	2	100	2
GP1L53VJ000F		High sensitivity, PWB mounting type	5.0	0.5	30	1	2	80	2	100	2
GP1L57J0000F		High sensitivity, wide gap, PWB mounting type	10.0	1.8	70	1	2	130	2	100	2

* Topr: -25 to +85°C

The model marked with ▲ may not be available in the near future. Contact with SHARP for details before use.



◆OPIC type ("OPIC" (Optical IC) is a trademark of SHARP Corporation. An OPIC consists of a light-detecting element and signal-processing circuit integrated onto a single chip.)

<Compact type>

(Ta = 25°C)

Model No.	Internal connection diagram	Features	Detecting and emitting gap (mm)	Slit width (mm)	Electro-optical characteristics							
					Threshold input current			Propagation delay time				
					IFLH (mA) MAX.	IFHL (mA) MAX.	VCC (V)	tPLH (μs) TYP.	tPHL (μs) TYP.	IF (mA)	RL (kΩ)	VCC (V)
GP1A98HCZ0F		Compact, PWB mounting	3.2	0.5	8	-	3.3 to 24	2.0	10.0	10	3.9 to 20	3.3 to 24
GP1A98HCPSF		Compact, surface mount	3.2	0.5	8	-	3.3 to 24	2.0	10.0	10	3.9 to 20	3.3 to 24

* Topr = -25 to +85°C

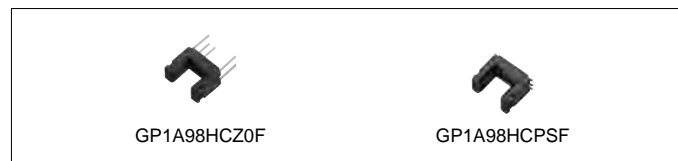

Notice

In the absence of confirmation by device specification sheets, SHARP takes no responsibility for any defects that may occur in equipment using any SHARP devices shown in catalogs, data books, etc.
 Except where specially indicated, models listed on this page comply with the RoHS Directive*. For details, please contact SHARP.
 *RoHS Directive: Prohibits use of lead, cadmium, hexavalent chromium, mercury and specific brominated flame retardants (PBBs and PBDEs), with certain exceptions.
 Contact SHARP in order to obtain the latest device specification sheets before using any SHARP device.



<Case type>

(Ta = 25°C)

Model No.	Internal connection diagram	Features	Detecting and emitting gap (mm)	Slit width (mm)	Electro-optical characteristics							
					Threshold input current			Propagation delay time				
					IFLH (mA) MAX.	IFHL (mA) MAX.	VCC (V)	tPLH (μs) TYP.	tPHL (μs) TYP.	IF (mA)	RL (Ω)	VCC (V)
GP1A50HRJ00F		Both-side mounting, with screw hole	3.0	0.5	5	–	5	3	5	5	280	5
GP1A51HRJ00F		Side mounting, with screw hole	3.0	0.5	5	–	5	3	5	5	280	5
GP1A52HRJ00F		PWB mounting type	3.0	0.5	5	–	5	3	5	5	280	5
GP1A53HRJ00F		PWB mounting type	5.0	0.5	8	–	5	3	5	8	280	5
GP1A57HRJ00F		PWB mounting type, with positioning pin	10.0	1.8	7	–	5	3	5	7	280	5
GP1A58HRJ00F		PWB mounting type, with positioning pin	5.0	0.5	8	–	5	3	5	8	280	5
GP1A52LRJ00F		PWB mounting type	3.0	0.5	–	5	5	5	3	5	280	5

* Topr = –25 to +85°C



Notice

In the absence of confirmation by device specification sheets, SHARP takes no responsibility for any defects that may occur in equipment using any SHARP devices shown in catalogs, data books, etc.
 Except where specially indicated, models listed on this page comply with the RoHS Directive*. For details, please contact SHARP.
 *RoHS Directive: Prohibits use of lead, cadmium, hexavalent chromium, mercury and specific brominated flame retardants (PBBs and PBDEs), with certain exceptions.
 Contact SHARP in order to obtain the latest device specification sheets before using any SHARP device.



◆ **OPIC type** (“OPIC” (Optical IC) is a trademark of SHARP Corporation. An OPIC consists of a light-detecting element and signal-processing circuit integrated onto a single chip.)

<With 3-pin connector terminal>

(Ta = 25°C)

Model No.	Internal connection diagram	Features	Detecting and emitting gap (mm)	Slit width (mm)	Electro-optical characteristics					
					Supply voltage V _{CC} (V)		V _{OL} (V) MAX.	Low level output voltage		
					MIN.	MAX.		Light cut-off	I _{OL} (mA)	V _{CC} (V)
GP1A173LCS2F		Snap-in mounting integrated connector type*1	5.0	0.5	4.5	5.5	0.35	No	4	5
GP1A173LCSVF		Snap-in mounting integrated connector type*1	5.0	0.5	4.5	5.5	0.35	No	4	5
GP1A273LCS1F		Integrated connector, compatible with 1.5 mm pitch connector, snap-in mounting type*1	5.0	0.7	4.5	5.5	0.35	No	4	5
GP1A73AJ000F		Compact, snap-in mounting type*1	5.0	0.5	4.5	5.5	0.35	No	4	5
GP1A073LCS		Compact, snap-in mounting type*1, low voltage operation	5.0	0.5	2.7	5.5	0.35	No	4	3
GP1A75EJ000F		Either-side mounting type Screw mounting type	5.0	0.5	4.5	5.5	0.35	Yes	16	5

* Topr: -20 to +75°C, -30 to +95°C (GP1A173LCS2F, GP1A173LCSVF, GP1A273LCS1F)

*1 Applicable to 3 kinds of thickness of mounting boards.

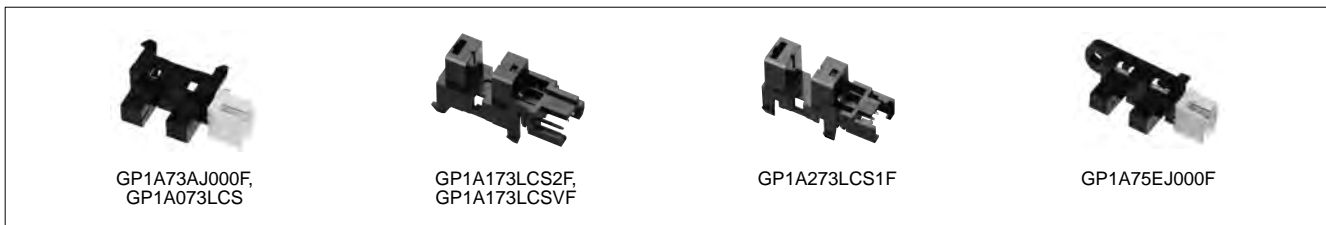

■ Photointerrupters

<Reflective type>

◆ **Single phototransistor output**

<Compact>

(Ta = 25°C)

Model No.	Internal connection diagram	Features	Standard detecting distance (mm)	Electro-optical characteristics							
				Current transfer ratio			Response time				
				CTR (%) MIN.	I _F (mA)	V _{CE} (V)	t _r (μs) TYP.	I _C (mA)	R _L (kΩ)	V _{CE} (V)	
GP2S700HCP		Compact (4 × 3 × 2 [height] mm), long focal distance, surface mounting leadless type	3	1.5	4	2	20	0.1	1	2	
GP2S60		Thin (3.2 × 1.7 × 1.1 [height] mm), surface mounting leadless type	0.5	1.0	4	2	20	0.1	1	2	

* Topr: -25 to +85°C

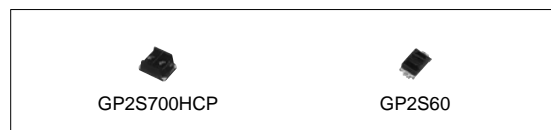

Notice

In the absence of confirmation by device specification sheets, SHARP takes no responsibility for any defects that may occur in equipment using any SHARP devices shown in catalogs, data books, etc. Except where specially indicated, models listed on this page comply with the RoHS Directive*. For details, please contact SHARP. *RoHS Directive: Prohibits use of lead, cadmium, hexavalent chromium, mercury and specific brominated flame retardants (PBBs and PBDEs), with certain exceptions. Contact SHARP in order to obtain the latest device specification sheets before using any SHARP device.



◆ **OPIC output** (“OPIC” (Optical IC) is a trademark of SHARP Corporation. An OPIC consists of a light-detecting element and signal-processing circuit integrated onto a single chip.)

<With 3-pin connector terminal>

(Ta = 25°C)

Model No.	Internal connection diagram	Features	Optimum detecting distance (mm)	Electro-optical characteristics					
				Supply voltage V _{CC} (V)		Dissipation current I _{CC} (mA) MAX.	Low level output voltage		
				MIN.	MAX.		V _{CC} (V)	V _{OL} (V) MAX.	V _{CC} (V)
GP2A200LCS0F	(Following diagram [A])	Multi types of paper detectable, light modulation type, with connector, sensitivity adjusted	5 to 15	4.75	5.25	30*1	5	0.4	5
GP2A240LCS0F		Applicable to inverter fluorescent lamp, light modulation type, with connector, sensitivity adjusted	5 to 15	4.75	5.25	30*1	5	0.4	5
GP2A250LCS0F		Static electricity resistant, applicable to inverter fluorescent lamp, light modulation type, with connector, sensitivity adjusted	2.5 to 12.5	4.75	5.25	30*1	5	0.4	5
GP2A25J0000F	(Following diagram [B])	Multi types of paper detectable, light modulation type, with connector, sensitivity adjusted	3 to 7	4.75	5.25	30*1	5	0.4	5
GP2A230LRS0F		Compact, hook type (GP2A231LRS0F), multi types of paper detectable, light modulation type, with connector	3 to 7	4.75	5.25	20*1	5	0.4	5
GP2A231LRS0F		Multi types of paper detectable, light modulation type, sensitivity adjusted, improved light-resistance characteristic for inverter lighting, built-in visible light cut filter	3 to 7	4.75	5.25	30*1	5	0.4	5
GP2A25NJJ00F	(Following diagram [A])	Multi types of paper detectable, light modulation type, with connector, sensitivity adjusted	3 to 7	4.75	5.25	30*1	5	0.4	5
GP2A25DJ000F		Multi types of paper detectable, light modulation type, with connector, sensitivity adjusted, hook type	3 to 7	4.75	5.25	30*1	5	0.4	5
GP2A28AJ000F		Multi types of paper detectable, light modulation type, with connector, sensitivity adjusted, hook type	3 to 7	4.75	5.25	30*1	5	0.4	5

* Topr: -10 to +60°C (GP2A25J0000F, etc.)

-10 to +70°C (GP2A200LCS0F, GP2A240LCS0F, GP2A250LCS0F, GP2A230LRS0F, GP2A231LRS0F)

*1 Smoothing value R_L = ∞

[Internal connection diagram]

[A]

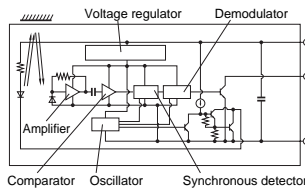

[B]

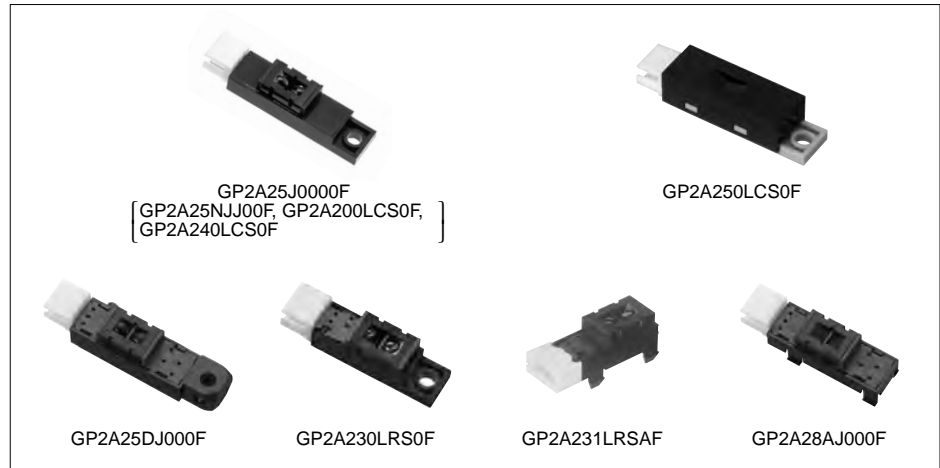
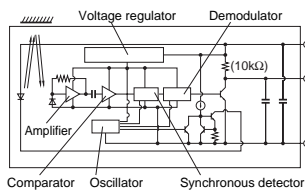

Notice

In the absence of confirmation by device specification sheets, SHARP takes no responsibility for any defects that may occur in equipment using any SHARP devices shown in catalogs, data books, etc. Except where specially indicated, models listed on this page comply with the RoHS Directive*. For details, please contact SHARP. *RoHS Directive: Prohibits use of lead, cadmium, hexavalent chromium, mercury and specific brominated flame retardants (PBBs and PBDEs), with certain exceptions. Contact SHARP in order to obtain the latest device specification sheets before using any SHARP device.



Photointerrupters for Specific Applications

◆ Transmissive type

<Case type, with encoder function>

(Ta = 25°C)

Model No.	Absolute maximum ratings			Electro-optical characteristics				
	Vcc (V)	Topr (°C)	Operating voltage Vcc (V) TYP.	Output signal	Resolution	Response frequency f (kHz) MAX.	If (mA)	Dissipation current (output side) Icc (mA) MAX.
GP1A057RBKLF	6	-10 to +70	3.3	Digital 2 output (Phase A/B)	Linear scale slit pitch 0.17 (mm) (150LPI)	60	20	7
GP1A054RDKLF	6	-10 to +70	3.3		Linear scale slit pitch 0.0847 (mm) (300LPI)	40	20	5.5
GP1A057SGKLF	6	-10 to +70	3.3		Linear scale slit pitch 0.56 (mm) (45LPI)	25	20	5.5
GP1A058SCK0F	6	-10 to +70	3.3		Linear scale slit pitch 0.14 (mm) (180LPI)	40	20	5.5
GP1A101C2KSF	6.5	-10 to +70	3.3	Digital 2 output (Multiplying output)	Resolution for reading: 180 LPI (Pitch: 0.14 mm) Output resolution: 360 LPI	120	20	20

* High precision read and low affection of angle error from vibration thanks to the multi-segment PD system.
Duty ratio: 50±15%, phase difference: 90±45°

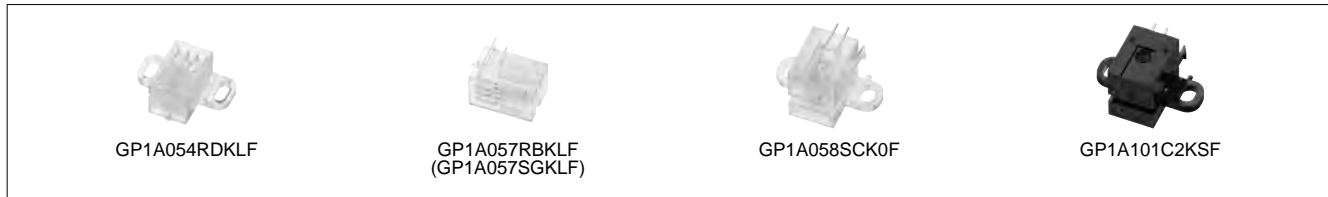

<For amusement use>

(Ta = 25°C)

Model No.	Internal connection diagram	Features	Detecting and emitting gap (mm)	Slit width (mm)	Electro-optical characteristics					
					Operating voltage Vcc (V)		Low level output voltage			
					MIN.	MAX.	Vol (V) MAX.	Light cut-off	IOL (mA)	VCC (V)
GP1A204HCS0		Connector with lock, screw mounting type, high resistant to noise	4.0	0.5	10.8	24	0.4	Yes	5	10.8 to 24



◆ Reflective type

<Case type, phototransistor output>

(Ta = 25°C)

Model No.	Internal connection diagram	Features	Electro-optical characteristics						
			Peak photocurrent			Response time			
			ICP (mA)	If (mA)	VCE (V)	tr (μs) TYP.	Ic (mA)	RL (kΩ)	VCE (V)
GP2S29SVJ00F		Long focal distance (with prism system*1), compact, screw mounting type	0.4 to 3.0*1	20	5	38	0.5	1	2

* Topr: -25 to +85°C

*1 Space between prism and sensor is 8 mm.



Notice

In the absence of confirmation by device specification sheets, SHARP takes no responsibility for any defects that may occur in equipment using any SHARP devices shown in catalogs, data books, etc.
Except where specially indicated, models listed on this page comply with the RoHS Directive*. For details, please contact SHARP.
*RoHS Directive: Prohibits use of lead, cadmium, hexavalent chromium, mercury and specific brominated flame retardants (PBBs and PBDEs), with certain exceptions.
Contact SHARP in order to obtain the latest device specification sheets before using any SHARP device.



<For amusement use>

(Ta = 25°C)

Model No.	Features	Electro-optical characteristics		
		Supply voltage V _{cc} (V)	Dissipation current I _{cc} (mA)	Response frequency f (Hz)
GP2A222HCKA	Employs reflective type, pinball detector, connector with lock In conjunction with an IC, detects beam interruption*1	4.5 to 16.5	MAX. 10	MAX. 500

*1 Used together with interface IC for control (IR3N184)



■ Proximity Sensor

(Ta = 25°C)

Model No.	Features	Absolute maximum ratings		Electro-optical characteristics				
		V _{cc} (V)	T _{opr} (°C)	Dissipation current I _{cc} (μA) TYP.	Detecting distance L _{on} (mm) MIN.	Non-detecting distance L _{off} (mm) MAX.	Maximum acceptable illuminance E _v (lx) MIN.	Peak emission wavelength λ _p (nm)
GP2AP002S00F	Compact size (4.0 × 2.0 × 1.25 t mm) Disparities in detecting distance results are greatly reduced using a built-in circuit for reduction of light-detecting sensitivity disparities Built-in LEDs for simple optical design and I ² C output	3.8	-25 to +85	240	25	150	3 000	940

Notice

In the absence of confirmation by device specification sheets, SHARP takes no responsibility for any defects that may occur in equipment using any SHARP devices shown in catalogs, data books, etc.
Except where specially indicated, models listed on this page comply with the RoHS Directive*. For details, please contact SHARP.
*RoHS Directive: Prohibits use of lead, cadmium, hexavalent chromium, mercury and specific brominated flame retardants (PBBs and PBDEs), with certain exceptions.
Contact SHARP in order to obtain the latest device specification sheets before using any SHARP device.

■ Proximity Sensor with Integrated Ambient Light Sensor

(Ta = 25°C)

Model No.	Features	Absolute maximum ratings		Electro-optical characteristics								
		Vcc (V)	Topr (°C)	Dissipation current Icc (μA) TYP.	Proximity sensor portion				Ambient light sensor portion			
					Detecting distance Lon (mm) MIN.	Non-detecting distance Loff (mm) MAX.	Maximum acceptable illuminance Ev (lx) MIN.	Peak emission wavelength λp (nm)	Recommended illuminance range Ev (lx) MIN.	Peak sensitivity wavelength λp (nm)	Output current	
Io1 (μA) TYP.	Io2 (μA) MAX.											
GP2AP002A00F	LED and ambient light sensor combined in a single package (5.6 × 2.1 × 1.25 t mm) Disparities in detecting distance results are greatly reduced using a built-in circuit for reduction of light-detecting sensitivity disparities Built-in LEDs for simple optical design Proximity sensor: I ² C output Ambient light sensor: logarithmic current output	3.8	-25 to +85	270	25	150	3 000	940	3 to 55 000	555	30 (at Ev = 1 000 lx)	1 (at Ev = 0 lx)

(Ta = 25°C)

Model No.	Features	Absolute maximum ratings		Electro-optical characteristics					
		Vcc (V)	Topr (°C)	Dissipation current Icc (μA) TYP.	Proximity sensor portion		Ambient light sensor portion		
					Detecting distance Lon (mm) MIN.	Peak emission wavelength λp (nm)	Recommended illuminance range Ev (lx)	Output resolution (bit)	ADC conversion time Tint (ms) TYP.
☆GP2AP020A00F	LED and ambient light sensor combined in a single package (4.0 × 2.0 × 1.25 t mm) Built-in LEDs for simple optical design Illuminance output: digital 16-bit output (Minimum detectable illuminance: 0.02 lx) I ² C output compatible (proximity sensor, ambient light sensor)	3.8	-35 to +85	70	45.5	940	0.2 to 131 072	16	100



Notice

In the absence of confirmation by device specification sheets, SHARP takes no responsibility for any defects that may occur in equipment using any SHARP devices shown in catalogs, data books, etc.
 Except where specially indicated, models listed on this page comply with the RoHS Directive*. For details, please contact SHARP.
 *RoHS Directive: Prohibits use of lead, cadmium, hexavalent chromium, mercury and specific brominated flame retardants (PBBs and PBDEs), with certain exceptions.
 Contact SHARP in order to obtain the latest device specification sheets before using any SHARP device.



■ Ambient Light Sensors

(Ta = 25°C)

Model No.	Type	Package	Absolute maximum ratings			Electro-optical characteristics						
			Vcc (V)	Io (mA)	Topr (°C)	Recommended supply voltage Vcc (V)	Recommended illuminance range Ev (lx)	Dissipation current Icc (μA) TYP.	Peak sensitivity wavelength λp (nm)	Output current		
											Io1 (μA) TYP.	Io2 (μA) TYP.
GA1A2S100SS	Built-in amplification circuit Peak sensitivity characteristic close to human visual sensitivity Output characteristic: Linear current output for illuminance Lead frame (straight) type	Transparent epoxy resin (3 × 4 mm)	7.0	5	-40 to +85	2.7 to 3.6	10 to 10 000	500	555	480 (at Ev = 1 000 lx)	48 (at Ev = 100 lx)	
GA1A2S100LY	Built-in amplification circuit Peak sensitivity characteristic close to human visual sensitivity Output characteristic: Linear current output for illuminance Lead frame (L bend) type		7.0	5	-40 to +85	2.7 to 3.6	10 to 10 000	500	555	480 (at Ev = 1 000 lx)	48 (at Ev = 100 lx)	
GA1A1S202WP	Built-in amplification circuit Peak sensitivity characteristic close to human visual sensitivity Output characteristic: Logarithmic current output for illuminance	Compact SMD (2.0 × 1.6 × 0.6 mm) Leadless	7.0	1	-40 to +85	2.3 to 3.2	3 to 55 000	70	555	20 (at Ev = 100 lx)	30 (at Ev = 1 000 lx)	
GA1A1S203WP	Built-in amplification circuit Peak sensitivity characteristic close to human visual sensitivity Output characteristic: Logarithmic current output for illuminance Thin type	Compact SMD (2.0 × 1.6 × 0.42 mm) Leadless	7.0	1	-40 to +85	2.3 to 3.2	3 to 55 000	70	555	20 (at Ev = 100 lx)	30 (at Ev = 1 000 lx)	
GA1A1S204WP	Built-in amplification circuit Peak sensitivity characteristic close to human visual sensitivity Output characteristic: Logarithmic current output for illuminance Back-mount-available type	Compact SMD (3.3 × 2.0 × 0.6 mm) Back-mount available, leadless	7.0	1	-40 to +85	2.3 to 3.2	3 to 55 000	70	555	20 (at Ev = 100 lx)	30 (at Ev = 1 000 lx)	
GA1A1S100WP	Built-in amplification circuit Peak sensitivity characteristic close to human visual sensitivity Output characteristic: Linear current output for illuminance	Compact SMD (2.0 × 1.6 × 0.6 mm) Leadless	7.0	10	-40 to +85	2.7 to 3.6	10 to 5 000	1 460	555	1 420 (at Ev = 1 000 lx)	142 (at Ev = 100 lx)	



GA1A2S100SS



GA1A2S100LY



GA1A1S202WP
(GA1A1S100WP)



GA1A1S203WP



GA1A1S204WP

Notice

In the absence of confirmation by device specification sheets, SHARP takes no responsibility for any defects that may occur in equipment using any SHARP devices shown in catalogs, data books, etc.
Except where specially indicated, models listed on this page comply with the RoHS Directive*. For details, please contact SHARP.
*RoHS Directive: Prohibits use of lead, cadmium, hexavalent chromium, mercury and specific brominated flame retardants (PBBs and PBDEs), with certain exceptions.
Contact SHARP in order to obtain the latest device specification sheets before using any SHARP device.



■ OPIC Light Detectors ("OPIC" (Optical IC) is a trademark of SHARP Corporation. An OPIC consists of a light-detecting element and signal-processing circuit integrated onto a single chip.)

(Ta = 25°C)

Model No.	Type	Package	Absolute maximum ratings				Electro-optical characteristics							
			V _{CC} (V)	P (mW)	I _O (mA)	T _{OPR} (°C)	EVLH (lx) MAX.	EVHL (lx) MAX.	V _{CC} (V)	t _{PLH} (μs) TYP.	t _{PHL} (μs) TYP.	V _{CC} (V)	E _V (lx)	R _L (Ω)
IS485E	Built-in schmidt trigger circuit, amplifier and voltage regulator	Transparent epoxy resin with condenser (lens)	-0.5 to +17	175	50	-25 to +85	-	35	5	5	3	5	50	280
IS486E			-0.5 to +17	175	50	-25 to +85	35	-	5	3	5	5	50	280



<Low-voltage operation>

(Ta = 25°C)

Model No.	Type	Package	Absolute maximum ratings			Electro-optical characteristics								
			P (mW)	I _O (mA)	T _{OPR} (°C)	Operating supply voltage (V)	EVLH (lx) MAX.	EVHL (lx) MAX.	V _{CC} (V)	t _{PLH} (μs) TYP.	t _{PHL} (μs) TYP.	V _{CC} (V)	E _V (lx)	R _L (Ω)
IS489E	Built-in Schmidt trigger circuit and amplifier	Transparent epoxy resin with condenser (lens)	80	2	-25 to +85	1.4 to 7.0	-	15	3	1.3	8.5	3	125	3 000



<Model employing a light modulation system>

(Ta = 25°C)

Model No.	Type	Package	Absolute maximum ratings				Electro-optical characteristics*2						External disturbing light illuminance E _{VDX} (lx) TYP.
			V _{CC} (V)	P (mW)	I _O (mA)	T _{OPR} (°C)	V _{OL} (V) MAX.	V _{OH} (V) MIN.	t _{PLH} (μs) TYP.	t _{PHL} (μs) TYP.	V _{CC} (V)	R _L (Ω)	
IS471FE*1, *3	Built-in pulse driver circuit at the emitter side, synchronous detector circuit, amplifier circuit and demodulator circuit	Visible light cut-off epoxy resin	-0.5 to +16	250	50	-25 to +60	0.35	4.97	400	400	5	280	7 000

*1 IS471FE is less susceptible to disturbing effects thanks to the light modulation system

*2 V_{CC} = 5 V

*3 Straight lead type (IS471FSE) is also available.



Notice

In the absence of confirmation by device specification sheets, SHARP takes no responsibility for any defects that may occur in equipment using any SHARP devices shown in catalogs, data books, etc.

Except where specially indicated, models listed on this page comply with the RoHS Directive*. For details, please contact SHARP. *RoHS Directive: Prohibits use of lead, cadmium, hexavalent chromium, mercury and specific brominated flame retardants (PBBs and PBDEs), with certain exceptions.

Contact SHARP in order to obtain the latest device specification sheets before using any SHARP device.



<For laser beam printers (laser beam origin detection)>

(Ta = 25°C)

Model No.	Type	Package	Electro-optical characteristics			
			Recommended supply voltage V _{CC} (V)	V _{OH} (V) MIN.	V _{OL} (V) MAX.	H → L delay time variation Δt _{PHL} (ns) MAX.
GA220T2L2IZ	2-PD, differential type	Transparent epoxy resin 18-pin	4.5 to 5.5	4.9	0.6	±8.5



Notice

In the absence of confirmation by device specification sheets, SHARP takes no responsibility for any defects that may occur in equipment using any SHARP devices shown in catalogs, data books, etc.
 Except where specially indicated, models listed on this page comply with the RoHS Directive*. For details, please contact SHARP.
 *RoHS Directive: Prohibits use of lead, cadmium, hexavalent chromium, mercury and specific brominated flame retardants (PBBs and PBDEs), with certain exceptions.
 Contact SHARP in order to obtain the latest device specification sheets before using any SHARP device.



■ Phototransistor Lineup

Package	Output type	Features	Half sensitivity angle	Model No.	
				Standard	Visible light cut-off
Epoxy resin with lens	Single phototransistor	General purpose/Narrow acceptance	±13°	PT480E0000F	PT480FE0000F
		Compact, thin	±35°	PT4800E0000F	PT4800FE0000F / PT4850FE0000F
	Darlington phototransistor	High sensitivity/Narrow acceptance	±13°	PT481E00000F	PT481FE0000F
		High sensitivity/Narrow acceptance/Long lead	±13°	—	PT483F1E000F
		High sensitivity/Compact, thin	±35°	PT4810E0000F▲	PT4810FE000F▲
		High sensitivity/Intermediate acceptance	±40°	—	PT491FE0000F
		High sensitivity/Intermediate acceptance/Long lead	±40°	—	PT493FE0000F▲
Surface mounting leadless type	Single phototransistor	Compact (side view/top view mounting possible)	±15°	PT100MC0MP	PT100MF0MP
		Darlington phototransistor	Compact (side view/top view mounting possible)	±15°	—

The model marked with ▲ may not be available in the near future. Contact with SHARP for details before use.



Phototransistors

Type	Model No.	Package	Absolute maximum ratings			Ic (mA)				ICEO(A)		Δθ (°) TYP.	λp (nm) TYP.
			VCEO (V)	Pc (mW)	ToPr (°C)	MIN.	MAX.	VCE (V)	Ee (mW/cm ²)	MAX.	VCE (V)		
Single	PT100MCOMP	Surface mounting leadless type with lens	35	75	-30 to +85	1.7	5.1	5	1	1 × 10 ⁻⁷	20	±15	900
	PT100MF0MP*1		35	75	-30 to +85	1.15	3.45	5	1	1 × 10 ⁻⁷	20	±15	910
	PT480E0000F	Epoxy resin with lens	35	75	-25 to +85	0.4	TYP. 1.7	5	1	1 × 10 ⁻⁷	20	±13	800
	PT480FE0000F*1		35	75	-25 to +85	0.25	TYP. 0.8	5	1	1 × 10 ⁻⁷	20	±13	860
	PT4800E0000F		35	75	-25 to +85	0.12	TYP. 0.4	5	1	1 × 10 ⁻⁷	20	±35	800
	PT4800FE0000F*1		35	75	-25 to +85	0.08	TYP. 0.25	5	1	1 × 10 ⁻⁷	20	±35	860
	PT4850FE0000F*1		35	75	-25 to +85	0.12	0.56	5	1	1 × 10 ⁻⁷	20	±35	860
Darlington	PT481E0000F	Epoxy resin with lens	35	75	-25 to +85	1.5	25	2	0.1	1 × 10 ⁻⁶	10	±13	800
	PT481FE0000F*1		35	75	-25 to +85	0.9	27	2	0.1	1 × 10 ⁻⁶	10	±13	860
	PT4810E0000F▲		35	75	-25 to +85	0.45	7.0	2	0.1	1 × 10 ⁻⁶	10	±35	800
	PT4810FJE000F*1▲		35	75	-25 to +85	0.27	6.0	2	0.1	1 × 10 ⁻⁶	10	±35	860
	PT483F1E0000F*1		35	75	-25 to +85	1.5	4.0	2	0.1	1 × 10 ⁻⁶	10	±13	860
	PT491FE0000F*1		35	75	-25 to +85	0.2	0.8	2	Ev, 2 lx	1 × 10 ⁻⁶	10	±40	860
	PT493FE0000F*1▲		35	75	-25 to +85	0.2	0.8	2	Ev, 2 lx	1 × 10 ⁻⁶	10	±40	860
	PT100MF1MP*1		Surface mounting leadless type with lens	35	75	-30 to +85	0.2	1.2	5	0.01	1 × 10 ⁻⁶	10	±15

*1 Visible light cut-off type

The model marked with ▲ may not be available in the near future. Contact with SHARP for details before use.

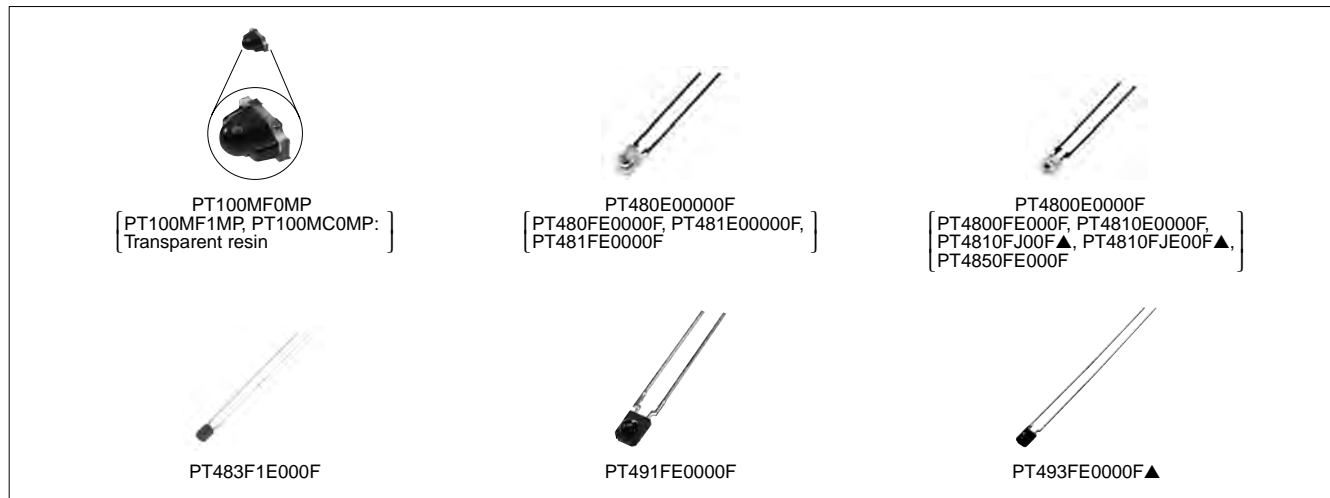

Notice

In the absence of confirmation by device specification sheets, SHARP takes no responsibility for any defects that may occur in equipment using any SHARP devices shown in catalogs, data books, etc.

Except where specially indicated, models listed on this page comply with the RoHS Directive*. For details, please contact SHARP.
*RoHS Directive: Prohibits use of lead, cadmium, hexavalent chromium, mercury and specific brominated flame retardants (PBBs and PBDEs), with certain exceptions.

Contact SHARP in order to obtain the latest device specification sheets before using any SHARP device.



■ PIN Photodiodes

(Ta = 25°C)

Model No.	Features	Package (Material)	Active area (mm ²)	Topr (°C)	Isc (μA) MIN.	Ev (lx)	Id (A) MAX.	VR (V)	tr, tf (μs) TYP.		λp (nm) TYP.	
									VR (V)	RL (kΩ)		
PD410PI2E00F	PIN type	Visible light cut-off epoxy resin with condenser (lens)	3.31	-25 to +85	2.5	100	1 × 10 ⁻⁸	10	0.2	10	1	1 000
PD411PI2E00F		Transparent epoxy resin with condenser (lens)	3.31	-25 to +85	5.0	100	1 × 10 ⁻⁸	10	0.2	10	1	960
PD412PI2E00F		Transparent epoxy resin with condenser (lens)	3.31	-25 to +85	3.5	100	1 × 10 ⁻⁸	10	0.25	10	1	800
PD413PI2E00F	PIN type IrDA1.0	Visible light cut-off epoxy resin with condenser (lens)	3.31	-25 to +85	MIN. 4.5 (TYP. 5.4)	100	1 × 10 ⁻⁸	10	0.2	10	1	960
PD100MC0MP	Surface mounting leadless type	Transparent epoxy resin board with lens	-	-30 to +85	0.6	100	1 × 10 ⁻⁸	10	0.01	15	0.18	820
PD100MF0MP	Surface mounting leadless type	Visible light cut-off epoxy resin board with lens	-	-30 to +85	0.4	100	1 × 10 ⁻⁸	10	0.01	15	0.18	850

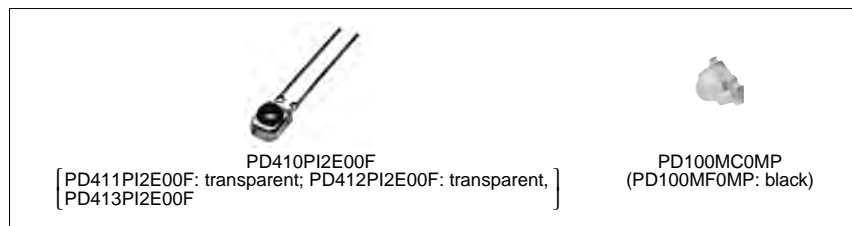

Notice

In the absence of confirmation by device specification sheets, SHARP takes no responsibility for any defects that may occur in equipment using any SHARP devices shown in catalogs, data books, etc.
 Except where specially indicated, models listed on this page comply with the RoHS Directive*. For details, please contact SHARP.
 *RoHS Directive: Prohibits use of lead, cadmium, hexavalent chromium, mercury and specific brominated flame retardants (PBBs and PBDEs), with certain exceptions.
 Contact SHARP in order to obtain the latest device specification sheets before using any SHARP device.



■ Infrared Emitting Diode Lineup

Type	Package	Features	Half intensity angle	Model No.
Single-end lead (Side view type)	Epoxy resin with lens	General purpose/Narrow beam angle	±13°	GL480E0000F
		Compact and thin	±30°	GL4800E0000F
	Flat epoxy resin	Wide beam angle	±90°	GL4100E0000F▲
Surface mount type	Epoxy resin with lens/ leadless (Mountable for Top view/ Side view type)	Compact/Narrow beam angle	±10°	GL100MN0MP
		High output type	±10°	GL100MN1MP
	Compact/Wide beam angle	±80°	GL100MD1MP1	

The model marked with ▲ may not be available in the near future. Contact with SHARP for details before use.

■ Infrared Emitting Diodes

(Ta = 25°C)

Model No.	Package, features	Absolute maximum ratings				Radiant flux Φ_e (mW)			V _F (V)			$\Delta\theta$ (°) TYP.	λ_p (nm) TYP.
		I _F (mA)	V _R (V)	P (mW)	T _{opr} (°C)	MIN.	TYP.	I _F (mA)	TYP.	MAX.			
GL480E0000F	Epoxy resin with lens	50	6	75	-25 to +85	0.7	-	20	1.2	1.4	20	±13	950
GL4800E0000F		50	6	75	-25 to +85	0.7	1.6	20	1.2	1.4	20	±30	950
GL4100E0000F▲	Side-view flat type, epoxy resin	50	6	75	-25 to +85	1.0	-	20	1.2	1.4	20	±90	950
GL100MN0MP	Surface mounting leadless type, epoxy resin board with lens	50	6	75	-30 to +85	1.0	3.0 (MAX.)	20	1.2	1.4	20	±10	940
GL100MN1MP	Surface mounting leadless type, epoxy resin board with lens, high output type	50	6	75	-30 to +85	2.0	6.0 (MAX.)	20	1.2	1.5	20	±10	940
GL100MD1MP1	Surface mounting leadless type, epoxy resin board with lens, wide beam angle	50	6	75	-30 to +85	-	6.0 (MAX.)	20	-	1.5	20	±80	940

The model marked with ▲ may not be available in the near future. Contact with SHARP for details before use.



Notice

In the absence of confirmation by device specification sheets, SHARP takes no responsibility for any defects that may occur in equipment using any SHARP devices shown in catalogs, data books, etc.
 Except where specially indicated, models listed on this page comply with the RoHS Directive*. For details, please contact SHARP.
 *RoHS Directive: Prohibits use of lead, cadmium, hexavalent chromium, mercury and specific brominated flame retardants (PBBs and PBDEs), with certain exceptions.
 Contact SHARP in order to obtain the latest device specification sheets before using any SHARP device.



Distance Measuring Sensor Lineup

Output	Range of distance measuring	Features	Model No.
1-bit digital output according to distance measuring	4 to 30 cm	1-bit digital output (detected distance: 15/13 cm)	GP2D150AJ00F/GP2Y0D413K0F
	10 to 80 cm	1-bit digital output (detected distance: 24 cm)	GP2Y0D21YK0F
	20 to 150 cm	1-bit digital output (detected distance: 80 cm)	GP2Y0D02YK0F
		Battery drive compatible, compact, 1-bit digital output (detected distance: 5/10 cm)	GP2Y0D805Z0F/GP2Y0D810Z0F
		Wide operating temperature type (-40 to +85°C) (detected distance: 10 cm)	GP2Y0D810Z1F
		Compact, thin 1-bit digital output (detected distance: 10/40 cm)	GP2Y0D310K/GP2Y0D340K
Analog voltage output according to distance measuring		Battery drive compatible, compact, 1-bit digital output (detected distance: 1.5 cm) Capable of operation at high temperature (-30 to +105°C)	GP2Y5D91S00F
	2 to 15 cm	Analog output	GP2Y0A51SK0F
	4 to 30 cm	Analog output	GP2Y0A41SK0F
	10 to 80 cm	Analog output	GP2Y0A21YK0F
	10 to 150 cm	Compact (22 × 8 × 7.2 [T] mm), Analog output	GP2Y0A60SZ0F/GP2Y0A60SZLF
	20 to 150 cm	Analog output	GP2Y0A02YK0F
	100 to 550 cm	Analog output	GP2Y0A710K0F

Wide Angle Sensor Lineup

Output	Range of distance measuring	Detection angle of view	Model No.
Voltage output according to distance measuring	4 to 30 cm	25° (When using 5 beams)	GP2Y3A001K0F
	20 to 150 cm	25° (When using 5 beams)	GP2Y3A002K0F
	40 to 300 cm	25° (When using 5 beams)	GP2Y3A003K0F

Paper Size Sensor (Using Optical Distance Measuring Method) Lineup

Output	Features	Model No.
1-bit output	1-beam (detection height: 60 mm) Thin type (T: 11.5 mm)	GP2Y2D160K0F
Analog output relative to measuring distance	1-beam (detection height: 80 mm) Thin type (T: 11.5 mm)	GP2Y2A180K0F
	2-beam (detection height: 80 mm) Thin type (T: 11.5 mm)	GP2Y2A280K0F

High-Precision Displacement Sensor

Output	Range of distance measuring	Features	Model No.
Voltage output according to distance measuring	4.5 to 6.0 mm	Resolution: 50 μm	GP2Y0AH01K0F

Dust Sensor Unit Lineup

Output	Features	Model No.
Analog output	Pulse analog output, single-shot detection of house dust, general purpose	GP2Y1010AU0F

Color Toner Concentration (Deposition Amount) Sensor Lineup

Output	Features	Model No.
Analog output	Employs diffuse reflection system + mirror reflection system	GP2TC2J0000F
	Employs diffuse reflection system + mirror reflection system	GP2Y40010K0F



Distance Measuring Sensors (1)

◆ Digital output

(Ta = 25°C)

Model No.	Features	Absolute maximum ratings		Electro-optical characteristics*1					
		Vcc (V)	Topr (°C)	Detected distance (cm)	Distance measuring range (cm)	VOH (V) MIN.	VOL (V) MAX.	Dissipation current	
								Operating (mA)	Standby (µA)
GP2Y0D805Z0F	Light detector, infrared LED and signal processing circuit, short distance measuring type, battery drive compatible (operating power supply: 2.7 to 6.2 V)	-0.3 to +7	-10 to +60	5	-	Vcc -0.6	0.6	MAX. 6.5	MAX. 8
GP2Y0D810Z0F	Light detector, infrared LED and signal processing circuit, short distance measuring type, battery drive compatible (operating power supply: 2.7 to 6.2 V)	-0.3 to +7	-10 to +60	10	-	Vcc -0.6	0.6	MAX. 6.5	MAX. 8
GP2Y0D810Z1F	Light detector, infrared LED and signal processing circuit, short distance measuring type, battery drive compatible (operating power supply: 2.7 to 6.2 V)	-0.3 to +7	-40 to +85	10	-	Vcc -0.6	0.6	TYP. 5	MAX. 8
GP2Y5D91S00F	Light detector, infrared LED and signal processing circuit, short distance measuring type, battery drive compatible (operating power supply: 2.7 to 6.2 V), capable of operation at high temperature	-0.3 to +7	-30 to +105	1.5	-	Vcc -0.6	0.6	TYP. 7	-
GP2Y0D310K	Digital voltage output according to the measured distance of GP2Y0D340K	-0.3 to +7	-10 to +60	10	-	Vcc -0.3	0.6	MAX. 35	-
GP2Y0D340K	Compact, thin type (15 x 9.6 x 8.7 mm: sensor part), Light detector, infrared LED and signal processing circuit, digital voltage output according to the measured distance	-0.3 to +7	-10 to +60	40	-	Vcc -0.3	0.6	MAX. 35	-
GP2Y0D21YK0F	Distance measuring sensor united with PSD*, infrared LED and signal processing circuit, digital voltage output	-0.3 to +7	-10 to +60	24	10 to 80	Vcc -0.3	0.6	MAX. 40	-
GP2D150AJ00F	Distance measuring sensor united with PSD*, infrared LED and signal processing circuit, digital voltage output	-0.3 to +7	-10 to +60	15	4 to 30	Vcc -0.3	0.6	MAX. 50	-
GP2Y0D413K0F	Distance measuring sensor united with PSD*, infrared LED and signal processing circuit, digital voltage output	-0.3 to +7	-10 to +60	13	4 to 30	Vcc -0.3	0.6	-	-
GP2Y0D02YK0F	Distance measuring sensor united with PSD*, infrared LED and signal processing circuit, long distance measuring type (No external control signal required), digital voltage output according to the measured distance	-0.3 to +7	-10 to +60	80	20 to 150	Vcc -0.3	0.6	MAX. 50	-

*1 Vcc = 5 V

* PSD: Position Sensitive Detector

Notice

In the absence of confirmation by device specification sheets, SHARP takes no responsibility for any defects that may occur in equipment using any SHARP devices shown in catalogs, data books, etc. Except where specially indicated, models listed on this page comply with the RoHS Directive*. For details, please contact SHARP. *RoHS Directive: Prohibits use of lead, cadmium, hexavalent chromium, mercury and specific brominated flame retardants (PBBs and PBDEs), with certain exceptions. Contact SHARP in order to obtain the latest device specification sheets before using any SHARP device.



Distance Measuring Sensors (2)

◆ Analog output

(Ta = 25°C)

Model No.	Features	Absolute maximum ratings		Electro-optical characteristics*1		
		Vcc (V)	Topr (°C)	Distance measuring range (cm)	VoH (V) MIN.	VoL (V) MAX.
GP2Y0A21YK0F	Distance measuring sensor united with PSD*, infrared LED and signal processing circuit, linear voltage output	-0.3 to +7	-10 to +60	10 to 80	Vo (TYP.) = 0.4 V (at L = 80 cm), ΔVo (TYP.) = 1.9 V (at L: 80 cm → 10 cm)	MAX. 40
GP2Y0A41SK0F	Distance measuring sensor united with PSD*, infrared LED and signal processing circuit, short measuring cycle (16.5 ms)	-0.3 to +7	-10 to +60	4 to 30	Vo (TYP.) = 0.4 V (at L = 30 cm), ΔVo (TYP.) = 2.25 V (at L = 30 cm → 4 cm)	MAX. 22
GP2Y0A51SK0F	Distance measuring sensor united with PSD*, infrared LED and signal processing circuit, short measuring cycle (16.5 ms)	-0.3 to +7	-10 to +60	2 to 15	Vo (TYP.) = 0.4 V (at L = 15 cm), ΔVo (TYP.) = 2.25 V (at L = 15 cm → 2 cm)	TYP. 12
GP2Y0A60SZ0F/ GP2Y0A60SZLF	*2 Distance measuring sensor united with PSD*, infrared LED and signal processing circuit, compact type (22 x 8 x 7.2 mm), long distance measuring type (No external control signal required)	-0.3 to +5.5	-10 to +60	10 to 150	Vo (TYP.) = 0.65 V (at L = 150 cm), ΔVo (TYP.) = 3.0 V (at L = 150 cm → 20 cm)	MAX. 50
GP2Y0A02YK0F	Distance measuring sensor united with PSD*, infrared LED and signal processing circuit, long distance measuring type (No external control signal required)	-0.3 to +7	-10 to +60	20 to 150	Vo (TYP.) = 0.4 V (at L = 150 cm), ΔVo (TYP.) = 2.05 V (at L = 150 cm → 20 cm)	MAX. 50
GP2Y0A710K0F	Distance measuring sensor united with PSD*, infrared LED and signal processing circuit, long distance measuring type (No external control signal required)	-0.3 to +7	-10 to +60	100 to 550	Vo (TYP.) = 2.5 V (at L = 100 cm), ΔVo (TYP.) = 0.7 V (at L = 100 cm → 200 cm)	TYP. 30

*1 Vcc = 5 V

*2 GP2Y0A60SZ0F: Surface mount type
GP2Y0A60SZLF: Board insertion type

*3 When Vcc = 3 V: Vo (TYP.) = 0.35 V (at L = 150 cm); ΔVo (TYP.) = 1.6 V (at L = 150 cm → 20 cm)

* PSD: Position Sensitive Detector

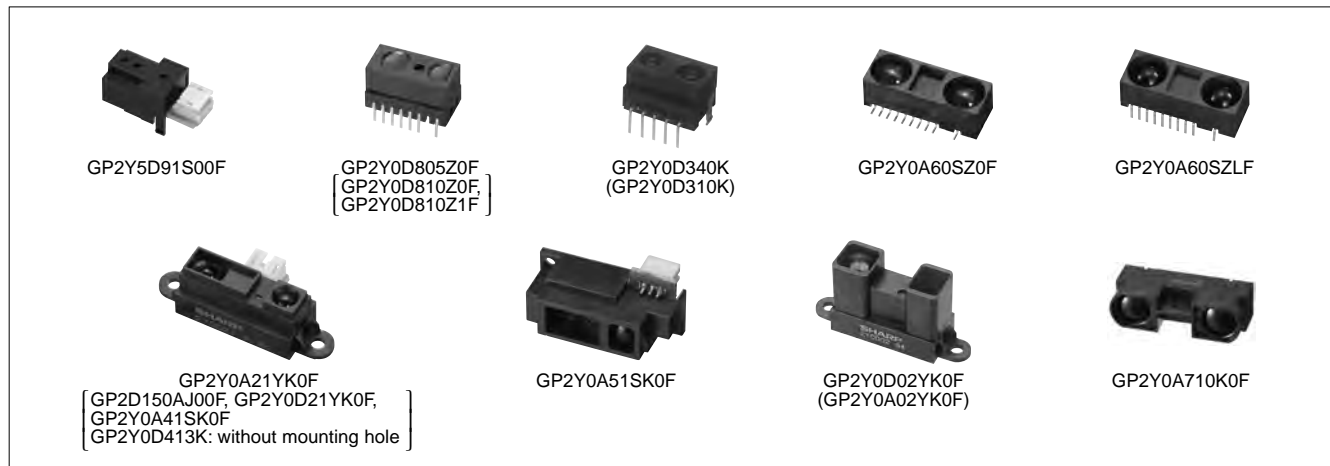

Notice

In the absence of confirmation by device specification sheets, SHARP takes no responsibility for any defects that may occur in equipment using any SHARP devices shown in catalogs, data books, etc.

Except where specially indicated, models listed on this page comply with the RoHS Directive*. For details, please contact SHARP.
*RoHS Directive: Prohibits use of lead, cadmium, hexavalent chromium, mercury and specific brominated flame retardants (PBBs and PBDEs), with certain exceptions.

Contact SHARP in order to obtain the latest device specification sheets before using any SHARP device.



Wide Angle Sensors

(Ta = 25°C)

Model No.	Features	Absolute maximum ratings		Electro-optical characteristics				
		Vcc (V)	Topr (°C)	Distance measuring range (cm)	Output terminal voltage (V)	Output voltage difference (V)	Input voltage (V)	
							V _{INH}	LEDL
GP2Y3A001K0F	Distance measuring sensor united with PSD*, infrared LED and signal processing circuit, distance measuring sensor application product, wide range (field of view) detection using 5 infrared beams	-0.3 to +7	-10 to +60	4 to 30	TYP. 2.85*1	TYP. 1.6*4	MIN. 4.5	MAX. 0.5
GP2Y3A002K0F		-0.3 to +7	-10 to +60	20 to 150	TYP. 2.3*2	TYP. 1.6*5	MIN. 4.5	MAX. 0.5
GP2Y3A003K0F		-0.3 to +7	-10 to +60	40 to 300	TYP. 2.3*3	TYP. 1.2*6	MIN. 4.5	MAX. 0.5

* PSD: Position Sensitive Detector

Reflector used: White paper (Gray chart R-27/white surface, made by Kodak Corp., reflectance 90%)

L = Reflector - Sensor distance

*1 L = 4 cm

*4 Change in output voltage from L = 4 cm to 10 cm

*2 L = 20 cm

*5 Change in output voltage from L = 20 cm to 80 cm

*3 L = 40 cm

*6 Change in output voltage from L = 40 cm to 100 cm



Paper Size Sensors

(Ta = 25°C)

Model No.	Features	Operating temperature	Supply voltage	Paper detection height	LED beam pitch	Approved value of paper position sliding	Paper detection density	Dissipation current
		Topr (°C)	Vcc (V)	H (mm)	Lp (mm)	Δx (mm)	OD	Icc (mA)
GP2Y2D160K0F	Thin type (T: 11.5 mm), using optical distance measuring method (1-beam), digital output (1-bit)	-10 to +65	5 ±0.5	TYP. 60	-	MIN. ±7.5	0.7 or less*1	MAX. 40
GP2Y2A180K0F	Thin type (T: 11.5 mm), analog output using optical distance measuring method (1-beam)	-10 to +65	5 ±0.5	TYP. 80	-	-	-	MAX. 25
GP2Y2A280K0F	Thin type (T: 11.5 mm), analog output using optical distance measuring method (2-beam)	-10 to +65	5 ±0.5	TYP. 80	TYP. 21	-	-	MAX. 50

* This table shows the characteristics when configured in the paper size sensor system.

*1 Reflectivity: 18% or more, OD = log (1/T), T: Reflectivity



High-Precision Displacement Sensor

(Ta = 25°C)

Model No.	Features	Topr (°C)	Operating supply voltage (V)	Dissipation current (mA)	Distance measuring range (mm)	Distance characteristic of output
GP2Y0AH01K0F	Resolution: 50 μ m	-10 to +60	4.5 to 5.5	TYP. 20	4.5 to 6.0	TYP. 1.70 V Variation in output over range (4.5 to 6.0 mm)



Notice

In the absence of confirmation by device specification sheets, SHARP takes no responsibility for any defects that may occur in equipment using any SHARP devices shown in catalogs, data books, etc.

Except where specially indicated, models listed on this page comply with the RoHS Directive*. For details, please contact SHARP. *RoHS Directive: Prohibits use of lead, cadmium, hexavalent chromium, mercury and specific brominated flame retardants (PBBs and PBDEs), with certain exceptions.

Contact SHARP in order to obtain the latest device specification sheets before using any SHARP device.



■ Dust Sensor Unit

(Ta = 25°C)

Model No.	Features	Topr (°C)	Electro-optical characteristics				
			Operating supply voltage (V)	Dissipation current (mA)	Detection sensitivity V/(0.1 mg/m ³)	Output voltage at no dust Voc (V)	Output voltage range Voh (V)
GP2Y1010AU0F	Built-in infrared emitting diode, photodiode and signal processing circuit, compact, single-shot detection of house dust	-10 to +65	4.5 to 5.5	TYP. 11	TYP. 0.5	TYP. 0.9	MIN. 3.4



■ Color Toner Concentration (Deposition Amount) Sensors

(Ta = 25°C)

Model No.	Features	Topr (°C)	Electro-optical characteristics		
			Dissipation current* ¹ (mA)	Output voltage* ² V ₀₁ (V)	Output voltage* ² V ₀₂ (V)
GP2TC2J0000F	Employs diffuse reflection system + mirror reflection system, high-precision detection of toner concentration on photo-sensitive drum, 2-line analog output (2-PD)	0 to +60	TYP. 4	TYP. 1.17	TYP. 2.81
GP2Y40010K0F	Employs diffuse reflection system + mirror reflection system, high-precision detection of toner concentration on transfer belt, 2-line analog output (2-PD)	0 to +60	TYP. 4	TYP. 1.27	MAX. 3.5 TYP. 2.87

*1 Dissipation current with LED current of I_{FM} = 0 mA

*2 With reflection object A (Reflectance: 15.6%)

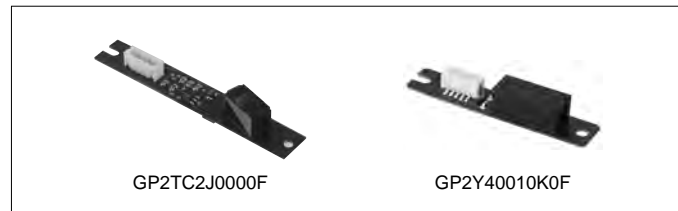

Notice

In the absence of confirmation by device specification sheets, SHARP takes no responsibility for any defects that may occur in equipment using any SHARP devices shown in catalogs, data books, etc. Except where specially indicated, models listed on this page comply with the RoHS Directive*. For details, please contact SHARP. *RoHS Directive: Prohibits use of lead, cadmium, hexavalent chromium, mercury and specific brominated flame retardants (PBBs and PBDEs), with certain exceptions. Contact SHARP in order to obtain the latest device specification sheets before using any SHARP device.



■ Fiber Optics Lineup for Audio Equipment

Connector type	Type	Outline	Features	High speed signal transmission	Model No.			
					Supply voltage 3 to 5 V	Supply voltage 5 V		
Square connector (EIAJ RC-5720B)	Fiber optic transmitter	Without mounting hole	With shutter	Horizontal mounting type	MAX. 13.2 Mb/s	GP1FMV51TK0F		
					MAX. 15.5 Mb/s	GP1FMV31TK0F		
		With mounting hole	With shutter	Horizontal mounting type	MAX. 13.2 Mb/s	GP1FAV51TK0F*1		
					MAX. 15.5 Mb/s	GP1FAV31TK0F		
					MAX. 50 Mb/s	GP1FAV55TK0F		
	Vertical mounting type			MAX. 13.2 Mb/s	GP1FSV51TK0F			
				MAX. 15.5 Mb/s	GP1FSV31TK0F (mounting height: 15 mm) GP1FSB31TK0F (mounting height: 8.5 mm)			
	Fiber optic receiver	Without mounting hole	With shutter	Horizontal mounting type	MAX. 13.2 Mb/s	GP1FMV51RK0F		
					MAX. 15.5 Mb/s	GP1FMV31RK0F		
					With mounting hole	With shutter	Horizontal mounting type	MAX. 13.2 Mb/s
MAX. 15.5 Mb/s								GP1FAV31RK0F
MAX. 13.2 Mb/s								GP1FAV50RK0F*1
MAX. 15.5 Mb/s	GP1FAV30RK0F							

*1 TTL drive compatible

Connector type	Type	Outline	Features	High speed signal transmission	Model No.
					Supply voltage 3 V
Optical mini-jack ø3.5 mm (JIS C 6650)	Fiber optic transmitter	Thin type (t: 4.2 mm)	Capable of detection/transmission of optical/electrical signals	MAX. 25 Mb/s	GP1FD320TP0F

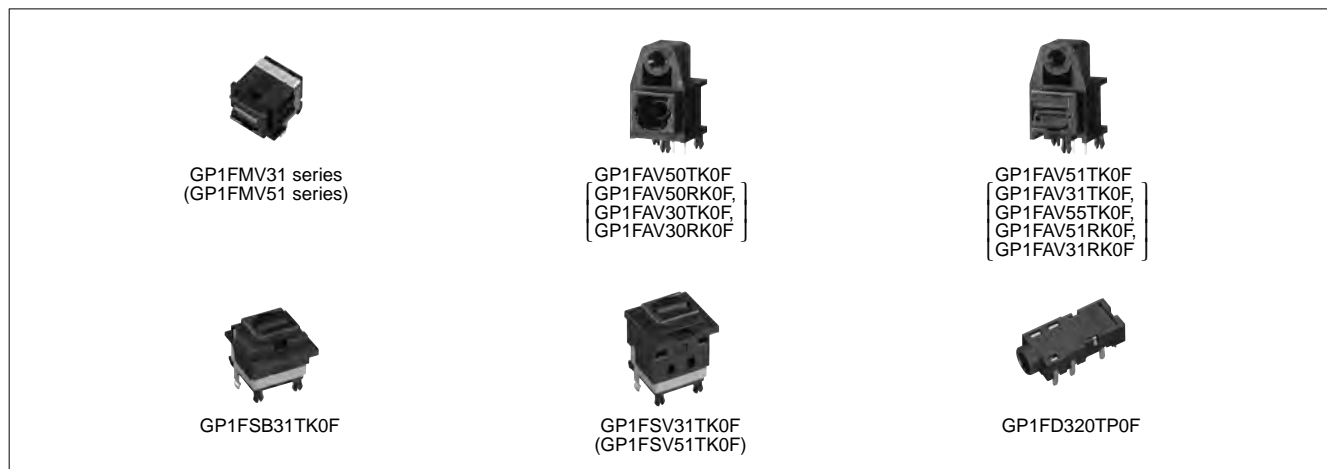



■ Fiber Optic Transmitters (Square Connector)

(Ta = 25°C)

Model No.	Appearance		Features	Absolute maximum ratings		Electro-optical characteristics					
	Mounting hole	Shutter		Vcc (V)	Topr (°C)	Supply voltage (V)	Propagation delay time		Dissipation current Icc (mA) MAX.	Pulse width distortion Δtw (ns)	Transmission speed T (Mb/s) MAX.
							tPLH (ns) MAX.	tPHL (ns) MAX.			
GP1FMV31TK0F	No	Yes	Compact	-0.5 to +7	-20 to +70	2.7 to 5.25	180	180	12	±15	15.5
GP1FMV51TK0F	No	Yes	Compact	-0.5 to +7	-20 to +70	4.75 to 5.25	180	180	13	±15	13.2
GP1FAV30TK0F	Yes	No	Low voltage drive, with protection cap	-0.5 to +7	-20 to +70	2.7 to 5.25	180	180	12	±15	15.5
GP1FAV50TK0F	Yes	No	TTL drive compatible, with protection cap	-0.5 to +7	-20 to +70	4.75 to 5.25 Input voltage: MIN. 2.0 V	180	180	13	±15	13.2
GP1FAV51TK0F	Yes	Yes	TTL drive compatible	-0.5 to +7	-20 to +70	4.75 to 5.25	180	180	13	±15	13.2
GP1FSV51TK0F	No	Yes	Vertical mounting (mounting height: 15 mm)	-0.5 to +7	-20 to +70	4.75 to 5.25	180	180	13	±15	13.2
GP1FAV31TK0F	Yes	Yes	Low voltage drive	-0.5 to +7	-20 to +70	2.7 to 5.25	180	180	12	±15	15.5
GP1FSV31TK0F	No	Yes	Vertical mounting (mounting height: 15 mm)	-0.5 to +7	-20 to +70	2.7 to 5.25	180	180	13	±15	15.5
GP1FAV55TK0F	Yes	Yes	High response speed	-0.5 to +7	-20 to +70	4.75 to 5.25	180	180	13	±15	50
GP1FSB31TK0F	No	Yes	Vertical mounting (mounting height: 8.5 mm)	-0.5 to +7	-20 to +70	2.7 to 5.25	180	180	13	±15	15.5

■ Fiber Optic Transmitters (ø3.5 mm Optical Mini-jack)

(Ta = 25°C)

Model No.	Features	Absolute maximum ratings			Electro-optical characteristics					
		Vcc (V)	Vin (V)	Topr (°C)	Supply voltage (V)	Propagation delay time		Dissipation current Icc (mA) MAX.	Pulse width distortion Δtw (ns)	Transmission speed T (Mb/s) MAX.
						tPLH (ns) MAX.	tPHL (ns) MAX.			
GP1FD320TP0F	Compact, thin type (t: 4.2 mm), high speed, optical mini-jack (low voltage type)	-0.5 to +7	-0.5 to Vcc + 0.5	-20 to +70	2.3 to 5.5	180	180	12	±11	25

■ Fiber Optic Receivers (Square Connector)

(Ta = 25°C)

Model No.	Appearance		Features	Absolute maximum ratings			Electro-optical characteristics					
	Mounting hole	Shutter		Vcc (V)	IoL (mA)	Topr (°C)	Supply voltage (V)	Propagation delay time		Dissipation current Icc (mA) MAX.	Pulse width distortion Δtw (ns)	Transmission speed T (Mb/s) MAX.
								tPLH (ns) MAX.	tPHL (ns) MAX.			
GP1FMV31RK0F	No	Yes	Compact, low voltage drive	-0.5 to +7	10	-20 to +70	2.7 to 3.6	180	180	15	±20	15.5
GP1FMV51RK0F	No	Yes	Compact	-0.5 to +7	10	-20 to +70	4.75 to 5.25	180	180	25	±20	13.2
GP1FAV30RK0F	Yes	No	Low voltage drive, with protection cap	-0.5 to +7	10	-20 to +70	2.7 to 3.6	180	180	15	±20	15.5
GP1FAV50RK0F	Yes	No	With protection cap	-0.5 to +7	10	-20 to +70	4.75 to 5.25	180	180	25	±20	13.2
GP1FAV51RK0F	Yes	Yes		-0.5 to +7	10	-20 to +70	4.75 to 5.25	180	180	25	±20	13.2
GP1FAV31RK0F	Yes	Yes	Low voltage drive	-0.5 to +7	10	-20 to +70	2.7 to 3.6	180	180	15	±20	15.5

Notice

In the absence of confirmation by device specification sheets, SHARP takes no responsibility for any defects that may occur in equipment using any SHARP devices shown in catalogs, data books, etc.
 Except where specially indicated, models listed on this page comply with the RoHS Directive*. For details, please contact SHARP.
 *RoHS Directive: Prohibits use of lead, cadmium, hexavalent chromium, mercury and specific brominated flame retardants (PBBs and PBDEs), with certain exceptions.
 Contact SHARP in order to obtain the latest device specification sheets before using any SHARP device.



High-Luminosity (AlGaInP) Surface Mount LEDs (Taped Models Only)

(IF = 20 mA, Tc = 25°C)

Outline dimensions (mm)	Resin type				JE		ZVJV		JS		JJ		ZRJR	
	Colored diffusion	Colored transparency	Colorless transparency	Milky diffusion	Yellow-green	Luminous intensity (mcd) TYP.	Amber	Luminous intensity (mcd) TYP.	Sunset orange	Luminous intensity (mcd) TYP.	Orange	Luminous intensity (mcd) TYP.	Red	Luminous intensity (mcd) TYP.
1.6 × 0.8 (t = 0.35)			●		GM1JE35200AE*1	13	GM1JV35200AE*1	18.8	GM1JS35200AE*1	19	GM1JJ35200AE*1	19	GM1JR35200AE*1	13
1.6 × 0.8 (t = 0.55)			●		GM1JE55200AE	13	GM1JV55200AE*1	16.8	GM1JS55200AE	20.9	GM1JJ55200AE	19	GM1JR55200AE	15
3.2 × 2.8 (t = 1.9)			●		-	-	GM5ZV96270A	600	-	-	-	-	GM5ZR96270A	600

*1 GM1JV35200AE series, GM1JV55200AE series: IF = 5 mA

High-Luminosity (InGaN) Surface Mount LEDs (Taped Models Only)

(IF = 5 mA, Ta = 25°C)

Outline dimensions (mm)	Resin type					BC		GC	
	Colored diffusion	Colored transparency	Colorless transparency	Milky diffusion	Blue	Luminous intensity (mcd) TYP.	Green	Luminous intensity (mcd) TYP.	
1.6 × 0.8 (t = 0.35)				●	GM1BC35372AC	35	GM1GC35370AC	80	

Surface Mount LEDs (Taped Models Only)

(IF = 20 mA, Ta = 25°C)

Outline dimensions (mm)	Resin type				EG		HY		HS		HD	
	Colored diffusion	Colored transparency	Colorless transparency	Milky diffusion	Yellow-green	Luminous intensity (mcd) TYP.	Yellow	Luminous intensity (mcd) TYP.	Sunset orange	Luminous intensity (mcd) TYP.	Red	Luminous intensity (mcd) TYP.
1.6 × 0.8 (t = 0.55)			●		GM1EG55200A	19	GM1HY55200A	11.5	GM1HS55200A	11.4	GM1HD55200A	12.5



GM1EG55200A series
GM1JV55200AE series



GM1JV35200AE series
GM1BC35372AC
GM1GC35370AC



GM5ZV96270A series

Notice

In the absence of confirmation by device specification sheets, SHARP takes no responsibility for any defects that may occur in equipment using any SHARP devices shown in catalogs, data books, etc. Except where specially indicated, models listed on this page comply with the RoHS Directive*. For details, please contact SHARP. *RoHS Directive: Prohibits use of lead, cadmium, hexavalent chromium, mercury and specific brominated flame retardants (PBBs and PBDEs), with certain exceptions. Contact SHARP in order to obtain the latest device specification sheets before using any SHARP device.

High-Luminosity White Surface Mount LEDs (Taped Models Only)

(Ta = 25°C*5)

Outline dimensions (mm)	Color coordinates (x, y) TYP.	BW			BN		
		White		High rendering color			
			Luminous intensity (mcd) TYP.	Color temperature (K) TYP.		Luminous intensity (mcd) TYP.	Color temperature (K) TYP.
2.8 × 1.2 (t = 0.8) Side view type	(0.30, 0.29)	GM4BW853A0A*1	1 900	–	–	–	–
		GM4BW853B0A*1	2 200	–	–	–	–
3.85 × 1.0 (t = 0.6) Side view type	(0.30, 0.29)	GM4BW653A0A*1	1 900	–	–	–	–
		GM4BW653B0A*1	2 200	–	–	–	–
	(0.29, 0.28)	–	–	–	GM4BN653C0A*1,4	1 700	–
3.2 × 2.8 (t = 1.9)	(0.31, 0.31)	GM5BW96382A*1	2 300	–	–	–	–
	(0.34, 0.36)	GM5BW96385A*1	2 600	–	–	–	–
	(0.29, 0.28)	GM5BW96387A*1	2 000	–	–	–	–
	(0.338, 0.365)	GM5BW97330A*2	6 400	5 300	–	–	–
	(0.312, 0.311)	GM5BW97332A*2	5 800	6 700	–	–	–
	(0.283, 0.262)	GM5BW97333A*2	5 100	11 500	–	–	–
	(0.3398, 0.3472)	–	–	–	–	GM5BN97330A*2,4	6 000
3.2 × 2.8 (t = 1.4)	(0.32, 0.33)	GM5BW94370A*3	5 200	–	–	–	–

*1 GM4BW853A0A series, GM4BW653A0A series, GM4BN653C0A, GM5BW96382A, GM5BW96385A, GM5BW96387A: If = 20 mA

*2 GM5BW97330A series, GM5BN97330A: If = 20 mA/chip

*3 GM5BW94370A: If = 25 mA/chip

*4 GM4BN653C0A and GM5BN97330A are high-NTSC-ratio products.

*5 GM5BW96382A, GM5BW96385A, GM5BW96387A, GM5BW97330A series, GM5BW94370A, GM5BN97330A: Tc = 25°C

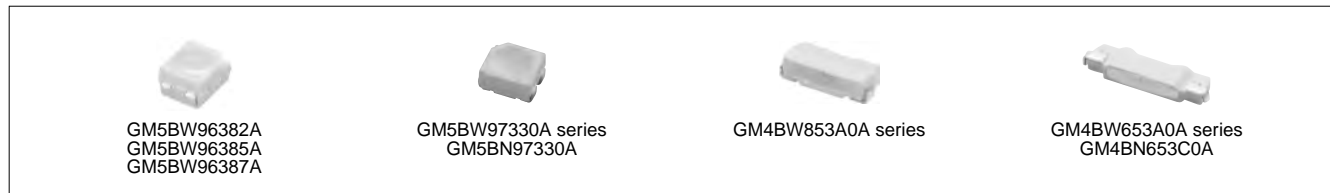

High-Luminosity Surface Mount LEDs (RGB 3-color) (Taped Models Only)

(Tc = 25°C)

Outline dimensions (mm)	Resin type				WA	
	Colored diffusion	Colored transparency	Colorless transparency	Milky diffusion	Red + Green + Blue	Luminous intensity (mcd) TYP.
1.6 × 1.6 (t = 0.55)				●	GM1WA55311A*1	20/70/23
3.2 × 2.8 (t = 1.4)				●	☆GM5WA94320A*2	(2 300) [Mixed color]
5.0 × 2.5 (t = 2.5)				●	GM4WA25300A*3	2 200 [Mixed color]

*1 GM1WA55311A: If = 5 mA (Red, Green, Blue)

*2 GM5WA94320A: If = 20 mA (Red), If = 20 mA (Green), If = 7 mA (Blue)

*3 GM4WA25300A: If = 21 mA (Red), If = 25 mA (Green), If = 7 mA (Blue)



Notice

In the absence of confirmation by device specification sheets, SHARP takes no responsibility for any defects that may occur in equipment using any SHARP devices shown in catalogs, data books, etc.

Except where specially indicated, models listed on this page comply with the RoHS Directive*. For details, please contact SHARP. *RoHS Directive: Prohibits use of lead, cadmium, hexavalent chromium, mercury and specific brominated flame retardants (PBBs and PBDEs), with certain exceptions.

Contact SHARP in order to obtain the latest device specification sheets before using any SHARP device.

ZENIGATA LEDs for Lighting (ZENIGATA is a registered trademark or a trademark of Sharp Corporation in Japan, the United States and/or other countries.)

<4W class>
(T_c = 25°C)

Outline dimensions (mm)	Model No.	Color temperature (K) TYP.	Forward voltage (V) TYP.	Forward current (mA) TYP.	Total luminous flux (lm) TYP.	Average color rendering index Ra TYP.
15.0 × 12.0 (t = 1.6)	GW5BMC27KG4	2 700	9.6	400	300	82
	GW5BMC30KG4	3 000			310	
	GW5BMC40KG4	4 000			330	
	GW5BMC50KG4	5 000			340	
	GW5BMC65KG4	6 500			340	

<6W class>
(T_c = 25°C)

Outline dimensions (mm)	Model No.	Color temperature (K) TYP.	Forward voltage (V) TYP.	Forward current (mA) TYP.	Total luminous flux (lm) TYP.	Average color rendering index Ra TYP.
15.0 × 12.0 (t = 1.6)	GW5BMF27K04	2 700	12.3	520	520	82
	GW5BMF30K04	3 000			535	
	GW5BMF40K04	4 000			570	
	GW5BMF50K04	5 000			585	
	GW5BMF65K04	6 500			585	

<9W class>
(T_c = 25°C)

Outline dimensions (mm)	Model No.	Color temperature (K) TYP.	Forward voltage (V) TYP.	Forward current (mA) TYP.	Total luminous flux (lm) TYP.	Average color rendering index Ra TYP.
15.0 × 12.0 (t = 1.6)	GW5BMJ27K04	2 700	18.6	480	720	82
	GW5BMJ30K04	3 000			740	
	GW5BMJ40K04	4 000			780	
	GW5BMJ50K04	5 000			800	
	GW5BMJ65K04	6 500			800	

<15W class>
(T_c = 25°C)

Outline dimensions (mm)	Model No.	Color temperature (K) TYP.	Forward voltage (V) TYP.	Forward current (mA) TYP.	Total luminous flux (lm) TYP.	Average color rendering index Ra TYP.
24.0 × 20.0 (t = 1.8)	GW5DMA27M04	2 700	37	400	1 350	83
	GW5DMA30M04	3 000			1 400	
	GW5DLA40M04	4 000			1 520	
	GW5DLA50M04	5 000			1 550	82
	GW5DLA65M04	6 500			1 550	
	GW5DGA27M04	2 700			1 150	
	GW5DGA30M04	3 000			1 170	
	GW5DGA40M04	4 000			1 230	92
	GW5DGA50M04	5 000			1 250	
	GW5DGA65M04	6 500			1 250	

Notice

In the absence of confirmation by device specification sheets, SHARP takes no responsibility for any defects that may occur in equipment using any SHARP devices shown in catalogs, data books, etc.
 Except where specially indicated, models listed on this page comply with the RoHS Directive*. For details, please contact SHARP.
 *RoHS Directive: Prohibits use of lead, cadmium, hexavalent chromium, mercury and specific brominated flame retardants (PBBs and PBDEs), with certain exceptions.
 Contact SHARP in order to obtain the latest device specification sheets before using any SHARP device.

<25W class>

(Tc = 25°C)

Outline dimensions (mm)	Model No.	Color temperature (K) TYP.	Forward voltage (V) TYP.	Forward current (mA) TYP.	Total luminous flux (lm) TYP.	Average color rendering index Ra TYP.
24.0 × 20.0 (t = 1.8)	GW5DMC27M04	2 700	37	700	2 300	83
	GW5DMC30M04	3 000			2 370	
	GW5DLC40M04	4 000			2 550	
	GW5DLC50M04	5 000			2 600	82
	GW5DLC65M04	6 500			2 600	
	GW5DGC27M04	2 700			1 910	93
	GW5DGC30M04	3 000			1 950	
	GW5DGC40M04	4 000			2 050	
	GW5DGC50M04	5 000			2 080	92
	GW5DGC65M04	6 500			2 080	

<50W class>

(Tc = 25°C)

Outline dimensions (mm)	Model No.	Color temperature (K) TYP.	Forward voltage (V) TYP.	Forward current (mA) TYP.	Total luminous flux (lm) TYP.	Average color rendering index Ra TYP.
24.0 × 20.0 (t = 1.8)	☆GW5DME27MR5	2 700	50	950	4 300	83
	☆GW5DME30MR5	3 000			4 430	
	☆GW5DLE40MR5	4 000			4 770	
	☆GW5DLE50M05	5 000			4 880	82
	☆GW5DLE65M05	6 500			4 880	
	☆GW5DGE27MR5	2 700			3 590	93
	☆GW5DGE30MR5	3 000			3 670	
	☆GW5DGE40MR5	4 000			3 850	
	☆GW5DGE50M05	5 000			3 900	92
	☆GW5DGE65M05	6 500			3 900	



GW5BMC27KG4 series



GW5BMF27K04 series



GW5BMJ27K04 series



GW5DMA27M04 series
GW5DGA27M04 series



GW5DMC27M04 series
GW5DGC27M04 series



GW5DME27MR5 series
GW5DGE27MR5 series

Notice

In the absence of confirmation by device specification sheets, SHARP takes no responsibility for any defects that may occur in equipment using any SHARP devices shown in catalogs, data books, etc.
 Except where specially indicated, models listed on this page comply with the RoHS Directive*. For details, please contact SHARP.
 *RoHS Directive: Prohibits use of lead, cadmium, hexavalent chromium, mercury and specific brominated flame retardants (PBBs and PBDEs), with certain exceptions.
 Contact SHARP in order to obtain the latest device specification sheets before using any SHARP device.



■ Surface Mount LEDs for Lighting (Taped Models Only)

(T_c = 25°C)

Outline dimensions (mm)	Model No.	Color temperature (K) TYP.	Forward voltage (V) TYP.	Forward current (mA) TYP.	Total luminous flux (lm) TYP.	Average color rendering index Ra TYP.
2.8 × 2.8 (t = 1.9)	GM2BB27QKAC	2 700	2.95	100	29.5	83
	GM2BB30QKAC	3 000			31	
	GM2BB35QKAC	3 500			32	
	GM2BB40QKAC	4 000			33.5	
	GM2BB45QKAC	4 500			34.5	
	GM2BB50QKAC	5 000			35.5	
	GM2BB57QKAC	5 700			35	
	GM2BB65QKAC	6 500		33.5		
	GM2BB27QK0C	2 700		150	44	
	GM2BB30QK0C	3 000			46	
	GM2BB35QK0C	3 500			48	
	GM2BB40QK0C	4 000			50	
	GM2BB45QK0C	4 500			51	
	GM2BB50QK0C	5 000			53	
	GM2BB57QK0C	5 700			52	
GM2BB65QK0C	6 500	50				

(T_c = 25°C)

Outline dimensions (mm)	Model No.	Color temperature (K) TYP.	Forward voltage (V) TYP.	Forward current (mA) TYP.	Luminous intensity (mcd) TYP.	Average color rendering index Ra TYP.
3.2 × 2.8 (t = 1.9)	GM5SAE27P0A	2 700	3.2	20	2 000	85
	GM5SAE30P0A	3 000			1 900	85
	GM5SAE35P0A	3 500			2 100	83
	GM5SAE40P0A	4 000			2 100	83
	GM5SAE45P0A	4 500			2 200	83
	GM5SAE50P0A	5 000			2 200	83
	GM5SAE57P0A	5 700			2 200	80
	GM5SAE65P0A	6 500			2 200	80

■ Surface Mount LEDs for Lighting (RGB 3-color) (Taped Models Only)

(I_F = 20 mA/chip, T_c = 25°C)

Outline dimensions (mm)	Model No.	Radiation color	Luminous intensity (mcd) TYP.
3.2 × 2.8 (t = 1.4)	GM5WA94315A	Red	680
		Green	1 500
		Blue	450



GM2BB27QKAC series
GM2BB27QK0C series



GM5SAE27P0A series



GM5WA94315A

Notice

In the absence of confirmation by device specification sheets, SHARP takes no responsibility for any defects that may occur in equipment using any SHARP devices shown in catalogs, data books, etc. Except where specially indicated, models listed on this page comply with the RoHS Directive*. For details, please contact SHARP. *RoHS Directive: Prohibits use of lead, cadmium, hexavalent chromium, mercury and specific brominated flame retardants (PBBs and PBDEs), with certain exceptions. Contact SHARP in order to obtain the latest device specification sheets before using any SHARP device.

■ LEDs for LCD Backlight

(T_c = 25°C)

Outline dimensions (mm)	Model No.	Color coordinates (x, y) TYP.	Forward voltage (V) TYP.	Forward current (mA) TYP.	Total luminous flux (lm) TYP.
2.8 × 2.8 (t = 1.9)	☆GM2BB0CH10A	(0.273, 0.244)	3.5	150	36.9
4.2 × 1.4 (t = 0.8)	☆GM5FM0CP10A	(0.260, 0.235)	3.2	130	36



**Notice**

In the absence of confirmation by device specification sheets, SHARP takes no responsibility for any defects that may occur in equipment using any SHARP devices shown in catalogs, data books, etc.
 Except where specially indicated, models listed on this page comply with the RoHS Directive*. For details, please contact SHARP.
 *RoHS Directive: Prohibits use of lead, cadmium, hexavalent chromium, mercury and specific brominated flame retardants (PBBs and PBDEs), with certain exceptions.
 Contact SHARP in order to obtain the latest device specification sheets before using any SHARP device.

■ Laser Diodes



◆ Model Configurations

• For applications other than optical discs

Wavelength (nm)	Absolute maximum ratings (mW)*1	Package	
		 ø5.6 mm Metal type	 ø3.3 mm Metal type
660 band	10	GH06510F2B	GH06510F4A
785 band	15	GH07815D2K	–
	15	GH3S215D2B	–
	25	GH07825D2K	–
	25	GH3S225D2B	–

*1 The absolute maximum ratings are the limits that are not to be exceeded under any condition whatsoever, whether in testing or in actual use.

• For optical disc use*3

Wavelength (nm)	Absolute maximum ratings (mW)*1	Package		
		 ø5.6 mm Metal type	 ø3.3 mm Metal type	 1.8 mm t Resin type
405 band	20	GH04020D2A	GH04020C4A	–
	320*2	GH04P32A2G	GH04P32A4G	–
	430*2	GH04P43A2G	GH04P43A4G	–
660 band	300*2	★GH06P30C1C	–	–
	350*2	–	–	GH16P35A8C
785 band	280*2	★GH07P28F1C	GH07P28F4C	–
Dual-wavelength 660/785 band	350/400*2	–	–	GH33540A8C

*1 The absolute maximum ratings are the limits that are not to be exceeded under any condition whatsoever, whether in testing or in actual use.

*2 Optical pulse power output MAX. (mW)

*3 New models for optical disc use are introduced frequently, and it is possible the model you wish to order may no longer be in production. Sample sales may not be available, either. We ask for your understanding in this matter.

◆ Specifications

• Laser diodes lineup for applications other than optical discs

(Tc = 25°C)

Model No.	Wave-length (nm)	Absolute maximum ratings*1	Features	Applications	Terminal connections
		CW (Continuous wave)			
GH06510F4A	660 band	10	ø3.3 mm CAN package, operating temperature: 70°C MAX., with built-in monitor PD	Bar code reader, laser displacement gauge, etc.	A
GH06510F2B		10	ø5.6 mm CAN package, operating temperature: 75°C MAX., with built-in monitor PD	Bar code reader, laser displacement gauge, etc.	G
GH07815D2K	785 band	15	ø5.6 mm CAN package, operating temperature: 60°C MAX., with built-in monitor PD	Printer, copier, complex machine	D
GH07825D2K		25	ø5.6 mm CAN package, operating temperature: 60°C MAX., with built-in monitor PD	Printer, copier, complex machine	
GH3S225D2B		25	ø5.6 mm CAN package, operating temperature: 60°C MAX., with built-in monitor PD	Printer, copier, complex machine	F
GH3S215D2B		15	ø5.6 mm CAN package, operating temperature: 60°C MAX., with built-in monitor PD	Printer, copier, complex machine	F

*1 The absolute maximum ratings are the limits that are not to be exceeded under any condition whatsoever, whether in testing or in actual use.

Notice

In the absence of confirmation by device specification sheets, SHARP takes no responsibility for any defects that may occur in equipment using any SHARP devices shown in catalogs, data books, etc.

Except where specially indicated, models listed on this page comply with the RoHS Directive*. For details, please contact SHARP. *RoHS Directive: Prohibits use of lead, cadmium, hexavalent chromium, mercury and specific brominated flame retardants (PBBs and PBDEs), with certain exceptions.

Contact SHARP in order to obtain the latest device specification sheets before using any SHARP device.

★Under development



• Laser diodes lineup for optical disc use*2

(Tc = 25°C)

Model No.	Wavelength (nm)	Absolute maximum ratings*1		Features	Applications	Terminal connections
		CW (Continuous wave)	Pulse			
GH04020D2A	405 band	20	—	ø5.6 mm CAN package, operating temperature: 75°C MAX.	Blu-ray disc playback	A
GH04020C4A		20	—	ø3.3 mm CAN package, operating temperature: 75°C MAX.	Blu-ray disc playback	A
GH04P32A2G		160	320	ø5.6 mm CAN package, operating temperature: 80°C MAX. (pulse drive)	Blu-ray disc recording	E
GH04P32A4G		160	320	ø3.3 mm CAN package, operating temperature: 80°C MAX. (pulse drive)	Blu-ray disc recording	E
GH04P43A2G		160	320	ø5.6 mm CAN package, operating temperature: 80°C MAX. (pulse drive)	Blu-ray disc recording	E
GH04P43A4G		160	320	ø3.3 mm CAN package, operating temperature: 80°C MAX. (pulse drive)	Blu-ray disc recording	E
★GH06P30C1C	660 band	100	250	ø5.6 mm CAN package, operating temperature: 75°C MAX. (pulse drive)	Double-layer DVD 8× to 16× recording	B
GH16P35A8C		125	350	1.8 mm frame package, operating temperature: 80°C MAX. (pulse drive)	Double-layer DVD 8× to 16× recording	C
★GH07P28F1C	785 band	150	280	ø5.6 mm CAN package, operating temperature: 80°C MAX. (pulse drive)	CD-R/RW (MAX. 48× to 52× writing)	B
GH07P28F4C		150	280	ø3.3 mm CAN package, operating temperature: 80°C MAX. (pulse drive)	CD-R/RW (H/H, slim dual-purpose) (MAX. 48× to 52× writing)	
GH33540A8C	Dual-wavelength 660/785 band	125	350	1.8 mm frame package, operating temperature: 80°C MAX. (pulse drive)	Double-layer DVD 8× to 16× recording	H
		200	400		CD-R/RW (H/H, slim dual-purpose) (MAX. 48× to 52× writing)	

*1 The absolute maximum ratings are the limits that are not to be exceeded under any condition whatsoever, whether in testing or in actual use. For recommended optical power output, consult the specification sheet or data sheet for each model.

*2 New models for optical disc use are introduced frequently, and it is possible the model you wish to order may no longer be in production. Sample sales may not be available, either. We ask for your understanding in this matter.

• Terminal Connections

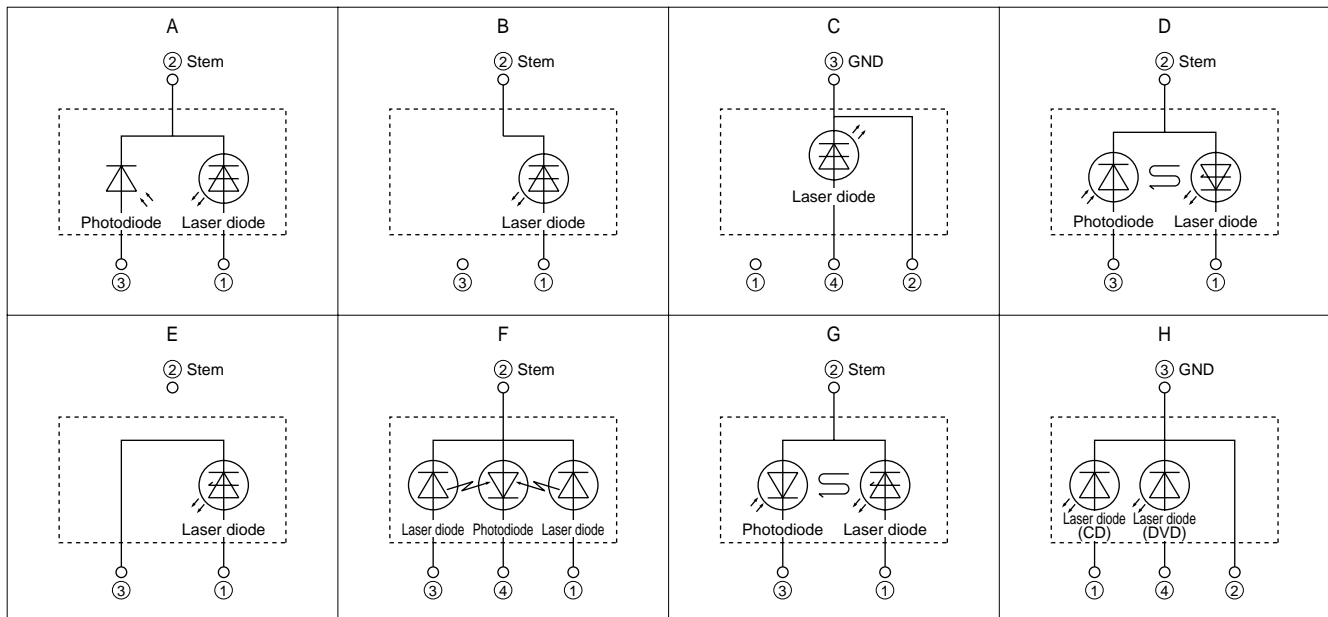

Notice

In the absence of confirmation by device specification sheets, SHARP takes no responsibility for any defects that may occur in equipment using any SHARP devices shown in catalogs, data books, etc. Except where specially indicated, models listed on this page comply with the RoHS Directive*. For details, please contact SHARP. *RoHS Directive: Prohibits use of lead, cadmium, hexavalent chromium, mercury and specific brominated flame retardants (PBBs and PBDEs), with certain exceptions. Contact SHARP in order to obtain the latest device specification sheets before using any SHARP device.

■ Europe: LNBs for Satellite Broadcast

◆ Features

- (1) Wide band type receiving all broadcasting channels (analog & digital) in Europe. [Universal LNB]
- (2) Originally developed feed-horn waveguide makes the wide-band, low-noise characteristics possible.
- (3) One of the industry's most compact and lightweight package
- (4) Low dissipation current design for energy saving [80 mA (TYP.): BS1K0EL150A]

◆ Specifications

Destination	Europe, Astra/Eutelsat Satellite etc.			
Receiving polarization	Horizontal/Vertical polarization			
Model No. <Type>	BS1R8EL500A <4 output>	BS1R8EL400A <4 output>	BS1K0EL250A <2 output>	BS1K0EL150A <1 output>
Input frequency (GHz)	10.7 to 11.7 [Low band], 11.7 to 12.75 [High band]			
Output frequency (MHz)	950 to 1 950 [Low band], 1 100 to 2 150 [High band]			
Local oscillation frequency (GHz)	9.75 [Low band], 10.6 [High band]			
NF (dB)	0.7 (TYP.)		0.4 (TYP.)	
Conversion gain (dB)	56 (TYP.)		58 (TYP.)	
Phase noise	-55 dBc/Hz at 1 kHz (TYP.)			
Cross-polar discrimination (dB)	25 (TYP.)			
Supply voltage (V DC) (Polarization switching)	Vertical polarization		11.5 to 14.0 (0/22 kHz)	
	Horizontal polarization		16.0 to 19.0 (0/22 kHz)	
Dissipation current (mA)	210 (TYP.)/250 (MAX.)	310 (TYP.)/350 (MAX.)	190 (TYP.)/250 (MAX.)	80 (TYP.)/120 (MAX.)
Waveguide	Feed-horn (F/D = 0.6)			
Output impedance (Ω)	75			
Output connector (F-type)	4-output (H/H, H/L, V/H, V/L)	4-output (H/V, High and low switching)	2-output (H/V, High and low switching)	1-output (H/V, High and low switching)
Outline dimensions (W) × (D) × (H) (mm)	133.0 × 103.6 × 60.0	133.0 × 103.6 × 60.0	135.0 × 90.0 × 58.0	103.0 × 60.0 × 60.0
Weight (g)	Approx. 255	Approx. 256	Approx. 245	Approx. 90



BS1R8EL500A



BS1R8EL400A



BS1K0EL250A



BS1K0EL150A

Notice

In the absence of confirmation by device specification sheets, SHARP takes no responsibility for any defects that may occur in equipment using any SHARP devices shown in catalogs, data books, etc. Contact SHARP in order to obtain the latest device specification sheets before using any SHARP device.

Japan/Asia/Australia: LNBs for CS Digital Satellite Broadcast

◆ Specifications

Destination	Japan, Asia, Australia, CS Satellite	
Receiving polarization	Horizontal/Vertical polarization	
Model No. <Type>	BS1R8AR100A	
Input frequency (GHz)	11.70 to 12.75	
Output frequency (MHz)	1 000 to 2 050	
Local oscillation frequency (GHz)	10.7	
NF (dB)	0.7 (TYP.) / 0.9 (MAX.)	
Conversion gain (dB)	55 to 64	
Phase noise	-75 dBc/Hz at 1 kHz (TYP.)	
Cross-polar discrimination (dB)	25 (TYP.)	
Supply voltage (V DC) (Polarization switching)	Vertical polarization	11.5 to 14.0
	Horizontal polarization	16.0 to 19.0
Dissipation current (mA)	80 (TYP.)/120 (MAX.)	
Waveguide	Feed-horn (F/D = 0.6)	
Output impedance (Ω)	75	
Output connector (F-type)	1-output (H/V switching)	
Outline dimensions (mm)	107.3 (W) × 60 (D) × 60 (H)	
Weight (g)	Approx. 110	



Japan: LNBs for BS/CS 110° Satellite Broadcast

◆ Features

- (1) Can receive 2 satellite broadcasts of 110° BS/CS digital
[Employs wide-band (1 GHz) circular' linear polarization conversion technology (septum waveguide structure)]
- (2) Outstanding noise figure (NF) characteristics enabling compact design of antenna diameter. [NF: 0.45 dB (TYP.)/BS1F6JU300A]
- (3) Low dissipation current design for improved energy saving. [80 mA (TYP.)]

◆ Standard Specifications

Destination	Japan BS/CS 110° Satellite		
Receiving polarization	Right circular polarization		Right/Left circular polarization
Model No.	BS1F9JU300A	BS1F6JU300A	BS1F6JP100A
Input frequency (GHz)	11.71023 to 12.751		
Output frequency (MHz)	1 032.23 to 2 073		
Local oscillation frequency (GHz)	10.678		
NF (dB)	0.45 (TYP.) / 0.6 (MAX.)		0.7 (TYP.) / 1.1 (MAX.)
Conversion gain (dB)	48 to 58		
Phase noise	-65 dBc/Hz at 1 kHz (TYP.)		
Cross-polar discrimination (dB)	25 (TYP.)/20 (MIN.)		
Supply voltage (V DC) (Polarization switching)	Right circular polarization	9.5 to 18.0	13.5 to 16.5
	Left circular polarization	—	9.5 to 12.0
Dissipation current (mA)	80 (TYP.)/110 (MAX.)		
Waveguide	Feed-horn (F/D = 0.5)		
Output impedance (Ω)	75		
Output connector (F-type)	1-output		1-output (R/L switching)
Outline dimensions (mm)	96 (W) × 47 (D) × 71 (H)		96 (W) × 53.07 (D) × 71 (H)
Weight* (g)	Approx. 100		Approx. 130

* Not including outer cabinet

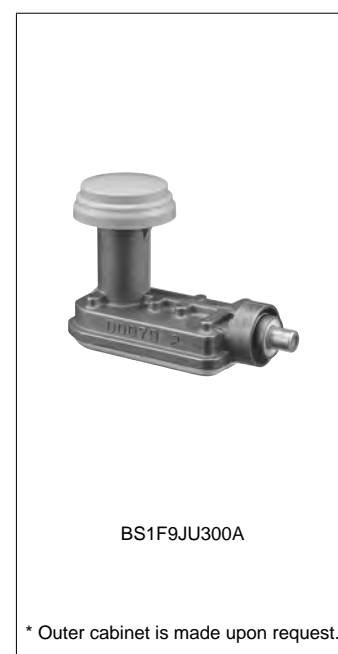

Notice

In the absence of confirmation by device specification sheets, SHARP takes no responsibility for any defects that may occur in equipment using any SHARP devices shown in catalogs, data books, etc. Contact SHARP in order to obtain the latest device specification sheets before using any SHARP device.



■ Digital DBS Front-End Units

◆ Features

- (1) Equipped with a direct conversion IC developed by Sharp. Reliability is improved by reducing power consumption and component counts.
- (2) Wide-band reception design also covering CS broadcast band. [Reception frequency: 950 to 2 150 MHz]
- (3) Wide product line-up of LINK integrated types for contributing to set development time reduction.
[Compatible with DVB-S/DVB-S2/ISDB-S/ABS-S demodulation]
- (4) User support tools can be provided. [Sample/evaluation boards and software are available.]

◆ Standard Specifications <IQ output type>

Destination	Global (ISDB-S/DVB-S2/ABS-S)	
Input type	1-input/1-loop through output	1-input
Model No.	BS2S7HZ7903	BS2S7HZ6903
Input frequency (MHz)	950 to 2 150	
Input signal level (dBm)	-65 to -25	
The 1st intermediate frequency (MHz)	Zero-IF (Direct conversion)	
Base band frequency bandwidth (MHz)	10 to 30, 2.0 MHz step (BB LPF)	
RF input local leak (dBm)	-68 and below	
Output type	I/Q	
Noise figure (dB)	8 (TYP.)	
Tuning voltage (V DC)	Shared with a 3.3 V power source	
Supply voltage (V DC)	3.3	
LNB power supply	DC 25 V, 400 mA (MAX.)	
Input impedance (Ω)	75	
Outline dimensions (mm)	32.6 (W) × 28.0 (D) × 13.0 (H)	

* Contact SHARP for custom design product.



◆ Standard Specifications <NIM type>

Destination	Europe (DVB-S2)	
Input type	1-input, 1-loop through output	1-input
Model No.	BS2F7VZ7702	BS2F7HZ1266
Input frequency (MHz)	950 to 2 150	
Input signal level (dB m)	-65 to -25	
The 1st intermediate frequency (MHz)	Zero-IF (Direct conversion)	
Base band frequency bandwidth (MHz)	10 to 30, 2.0 MHz step (BB LPF)	
RF input local leak (dB m)	-70 and below	
Output type	Transport stream (parallel/serial)	
Symbol rate (M baud)	45 (MAX.)	
Noise figure (dB)	8 (TYP.)	5 (TYP.)
Tuning voltage (V DC)	Shared with a 3.3 V power source	
Supply voltage (V DC)	3.3, 1.2	3.3, 1.0
LNB power supply	25 V DC, 400 mA (MAX.)	
Input impedance (Ω)	75	
Outline dimensions (mm)	57.5 (W) × 29.6 (D) × 13.2 (H)	56.0 (W) × 34.9 (D) × 10.0 (H)

* Contact SHARP for custom design product.

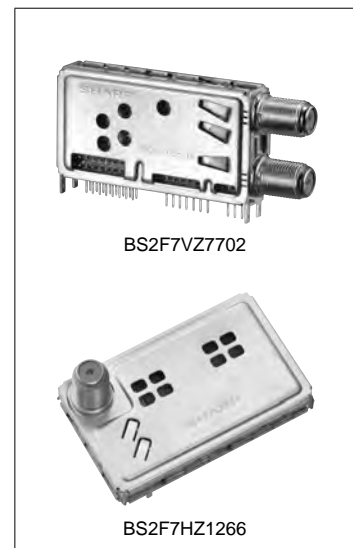

Notice

In the absence of confirmation by device specification sheets, SHARP takes no responsibility for any defects that may occur in equipment using any SHARP devices shown in catalogs, data books, etc. Contact SHARP in order to obtain the latest device specification sheets before using any SHARP device.



■ Front-End Units for ISDB-T/DVB-T/CTTB/CATV and Digital Satellite

◆ Features

- (1) Low phase noise characteristics, high elimination of adjacent channel interference.
- (2) Compact, low power consumption.

◆ Standard Specifications

Destination	Japan (ISDB-T/S)			
Model No.	VA4M5JC2116		VA4M6JC2103	
	Digital terrestrial	Digital satellite	Digital terrestrial	Digital satellite
Number of tuners	1	1	2	2
Input frequency (MHz)	93 to 767	950 to 2 150	93 to 767	950 to 2 150
Output type	Low-IF	I, Q	Low-IF	I, Q
Noise figure (dB)	6 (TYP.)			
Phase noise (dBc/Hz) at 10 kHz offset	-90 (TYP.)	-85 (TYP.)	-90 (TYP.)	-85 (TYP.)
Supply voltage (V DC)	1.8, 3.3	3.3	1.8, 3.3	3.3
Power consumption (W)	0.5	0.6	1	1.1
Outline dimensions (mm)	50.0 (W) × 45.0 (D) × 5.8 (H)			

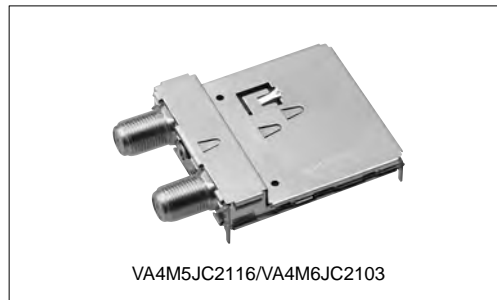

Notice

In the absence of confirmation by device specification sheets, SHARP takes no responsibility for any defects that may occur in equipment using any SHARP devices shown in catalogs, data books, etc. Contact SHARP in order to obtain the latest device specification sheets before using any SHARP device.



■ Front-End Units for ISDB-T/DVB-T/CTTB/CATV

◆ Features

- (1) Low phase noise characteristics, high elimination of adjacent channel interference.
- (2) Compact, low power consumption.
- (3) Other types are available with various chassis forms (vertical or horizontal type) and input connectors (F or DIN type), etc.

◆ Standard Specifications

Destination	Europe/Asia (DVB-T2)		China (DTMB)	Brazil (ISDB-TB)
	Terrestrial	Terrestrial/Satellite	Terrestrial	Terrestrial
Model No.	VA4M1EX6158	VA4S5DC5072	VA4N1CD1136	VA4N1BD1108
Input frequency (MHz)	47 to 868	47 to 868 950 to 2 150	47 to 868	54 to 868
Output type	TS	DIF I/Q	DIF	
	—	CVBS/SIF	AIF	
Noise figure (dB)	Terrestrial: 6 (MAX.)	Terrestrial: 6 (MAX.) Satellite: 6 (TYP.)	Terrestrial: 6 (MAX.)	
Phase noise (dBc/Hz)	Terrestrial: -90	Terrestrial: -90 Satellite: -85	Terrestrial: -90	
Power consumption (W)	1.1	Terrestrial: 1.0 Satellite: 0.5	Terrestrial: 1.26	Terrestrial: 1.16
Supply voltage (V DC)	3.3, 1.8, 1.2	3.3, 1.8	3.3	
Outline dimensions (mm)	47 (W) × 30 (D) × 13 (H)	32 (W) × 40 (D) × 6.7 (H)	32 (W) × 36 (D) × 6.7 (H)	34 (W) × 37 (D) × 6.7 (H)



Notice

In the absence of confirmation by device specification sheets, SHARP takes no responsibility for any defects that may occur in equipment using any SHARP devices shown in catalogs, data books, etc. Contact SHARP in order to obtain the latest device specification sheets before using any SHARP device.



■ Front-End Units for Digital Terrestrial and Analog Terrestrial Broadcasting

◆ Features

Contributing to the development of thinner LCD TVs and similar products by combining compatibility with digital and analog terrestrial broadcasts into a single unit.

◆ Standard Specifications

Destination		Brazil*1	China
Model No.		VA4A1BC5038	VA1P1CD8402
Input frequency (MHz)		47 to 866	47 to 870
Analog intermediate frequency (MHz)	Video	45.75	38.0
	Audio	41.25	D/K: 31.5, I: 32.0, B/G: 32.5, M/N: 33.5
Digital intermediate frequency (MHz)		44	36
Digital IF bandwidth (MHz)		6	8
Phase noise (dBc/Hz)		-90 (TYP.) at 10 kHz offset	-85 (TYP.) at 10 kHz offset
Supply voltage (V DC)		1.8, 3.3	5.0
Noise figure (dB)		6 (TYP.)	
Channel selection system		PLL (I ² C-bus)*2	
Outline dimensions (W) × (D) × (H) (mm)		40 × 36.6 × 5	70.0 × 37.0 × 10.0

*1 Transport stream output front-end units with built-in OFDM demodulation IC

*2 I²C-bus is a trademark of Philips Corporation.



◆ Features

Universal specifications compatible with various broadcasting systems all over the world

Digital: DVB-T/T2, DVB-C, ATSC, ISDB-T, DTMB

Analog: NTSC-M/N, PAL-B/G/I/DK, SECAM-L, L'

◆ Standard Specifications

Destination		Japan	Global
Model No.		VA4D1JA2160	VA4M1DA5167
Input frequency (MHz)		93 to 767	47 to 868
Output type	Digital terrestrial	DIF	
	Analog terrestrial	-	AIF
Noise figure (dB)		6 (MAX.)	4 (TYP.)
Phase noise (dBc/Hz)		-90 (TYP.)	
Supply voltage (V)		1.8, 3.3	3.3
Power consumption (W)	Digital terrestrial	0.5	T.B.D.
	Analog terrestrial	-	T.B.D.
Outline dimensions (W) × (D) × (H) (mm)		32.0 × 22.0 × 6.7	

※ Contact SHARP for custom design product.

(For connector shape or facing side, analog output format, etc.)



Notice

In the absence of confirmation by device specification sheets, SHARP takes no responsibility for any defects that may occur in equipment using any SHARP devices shown in catalogs, data books, etc. Contact SHARP in order to obtain the latest device specification sheets before using any SHARP device.

Full-Seg Tuner Module for Diversity Reception

◆ Features

Compact package, enabling 4-diversity reception (35.0 × 31.0 × 2.95 mm)

◆ Standard Specifications

Destination		Japan
Model No.		VA3D5JZ705
Type		Built-in diversity demodulator for four signal reception
Input frequency (MHz)		470 to 770
IF frequency (MHz)		4
Output type		Transport stream
Input sensitivity (dBm)	During diversity reception	-88 (TYP.) (64QAM, CR = 3/4)
	During single reception	-82 (TYP.) (64QAM, CR = 3/4)
Supply voltage (V)		Vcc1: 1.2, Vcc2: 3.3 (IO: 3.3)
Power consumption (W)		1.24 (TYP.)
Operating temperature (°C)		-40 to 85
Control interface		I ² C-bus*1
Outline dimensions (W) × (D) × (H) (mm)		35.0 × 31.0 × 2.95

Diversity demodulator for two signal reception is also available.

*1 I²C-bus is a trademark of Philips Corporation.

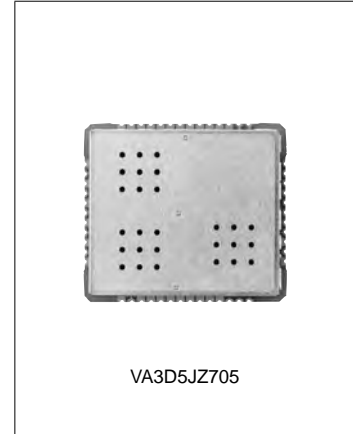

MPEG Module

◆ Features

- (1) An OFDM demodulator, MPEG decoder and video encoder circuit are combined into a single package for reception of ISDB-T.
- (2) Comes with built-in standard reception software, with a simple EPG included, based on the ARIB standard.
Compatible with Ministry of Internal Affairs and Communications specifications for a "simple tuner."
Compatible also with full HD output.
- (3) Optional One-seg broadcasting compatibility is available for diversity-reception and integrated-RF types.

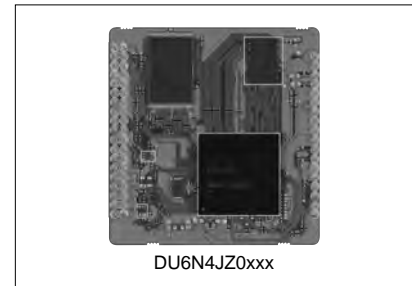

◆ Standard Specifications

Type	For digital terrestrial	For digital terrestrial/BS/CS	For digital terrestrial Compatible with diversity reception	For digital terrestrial only Integrated RF
Model No.	DU6N4JZxxxx	DU6U4JZxxxx	DU6U4JZxxxx	DU6F4JZxxxx
Circuit configuration	[RF (separate body) +] OFDM + MPEG			RF + OFDM + MPEG
CATV (pass-through)	○		-	○
Video output	Component (Full HD)*			
Audio output	Analog stereo (L/R)			
B-CAS	Built-in control software			
EPG	Built-in simple EPG			
ES (Engineering service)	○			
Firm ware upgrades	○			
Supply voltage (V)	3.3/1.8/1.0			
Power consumption (W)	1.1 (TYP.)			1.5 (TYP.)
Outline dimensions (mm)	58 (W) × 60 (D) × 7 (H)	60 (W) × 70 (D) × 7 (H)		78 (W) × 55.5 (D) × 7 (H)
Recommended front-end	VA4D1JA2160	VA1N5JF8627	VA3D5JZ705	-

* Switchable between S-Video (Y/C) and component (SD or HD).

Notice

In the absence of confirmation by device specification sheets, SHARP takes no responsibility for any defects that may occur in equipment using any SHARP devices shown in catalogs, data books, etc. Contact SHARP in order to obtain the latest device specification sheets before using any SHARP device.



■ MPEG Module with Video Recording Function

◆ Features

- (1) Comes with built-in USB interface for recording.
Capable of recording a counter program if a double tuner is installed on the device as well.
- (2) Fully compliant with ARIB standard.
Compatible with interactive data broadcasting.

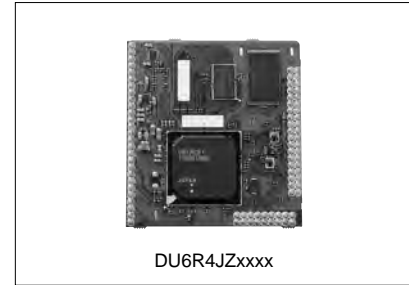

◆ Standard Specifications

Type	For digital terrestrial/BS/CS	
	Double type	Single type
Model No.	DU6R4JZxxxx	
CATV (pass-through)	○	
Video output / Audio output	Component (Full HD)* / Analog stereo (L/R)	
B-CAS	Built-in control software	
EPG	Built-in EPG	
ES (Engineering service)	○	
Firm ware upgrades	○	
Supply voltage (V)	5/3.3/1.8/1.2/1.05	
Power consumption (W)	2.9	
Outline dimensions (mm)	65 (W) × 80 (D) × 7 (H)	65 (W) × 70 (D) × 7 (H)
Recommended front-end	VA4M6JC2103	VA4M5JC2116

* Switchable between S-Video (Y/C) and component (SD or HD).

■ One-Seg Tuner Module

◆ Features

- (1) High sensitivity: -100 dBm (13 seg, QPSK CR: 2/3)
- (2) Compact and thin design: 5.4 × 5.4 × 1.0 mm
- (3) Low power consumption: 41 mW (with software power control)
- (4) Output interface: TS serial output



◆ Standard Specifications

Destination	Japan
Model No.	VA3A5JZ967
Input frequency (MHz)	470 to 770 (UHF: 13 to 62)
Input signal level (dBm)	-100 (13 seg, QPSK CR: 2/3)
Outline dimensions (mm)	5.4 (W) × 5.4 (D) × 1.0 (H)
Supply voltage (V DC)	1.2 (RF) 1.2 (OFDM Core) 1.62 to 3.6 (I/O)
Power consumption (mW)	41 (TYP.)
Operating temperature (degree C)	-20 to 65
Control I/F	I ² C-bus*1

*1 I²C-bus is a trademark of Philips Corporation.

Notice

In the absence of confirmation by device specification sheets, SHARP takes no responsibility for any defects that may occur in equipment using any SHARP devices shown in catalogs, data books, etc. Contact SHARP in order to obtain the latest device specification sheets before using any SHARP device.



■ Embedded Wireless LAN-Bluetooth Combo Module

◆ Features

- (1) A two-in-one module compliant with the latest Bluetooth standard (v2.1)
Wireless LAN: 11b/g, Bluetooth: v2.1+EDR* (3 Mbps)
- (2) Compatible with IEEE802.15.2 standard compliant wireless LAN and Bluetooth coexistence functions.
- (3) Compact and thin design
9.0 × 9.0 × 1.25 mm

*EDR: Enhanced Data Rate



DC2K1DZ172

◆ Standard Specifications

Model No.	DC2K1DZ172	
Wireless communication standard	WLAN (IEEE802.11b/g)	Bluetooth v2.1+EDR
Outline dimensions (mm)	9.0 (W) × 9.0 (D) × 1.25 (H) (LTCC)	
Frequency (MHz)	2 400 to 2 483.5	2 402 to 2 480
Data rate (Mbps)	1/2/5.5/11 & 6/9/12/18/24/36/48/54	1/2/3
Number of channels	13	79
Transmission output (dBm)	11g: +14/11b: +18	Class 2
Receiving sensitivity (dBm)	TYP.: -84 (11 Mbps, PER 8%) TYP.: -71 (54 Mbps, PER 10%)	TYP.: -70 (1 Mbps, BER 0.1%) TYP.: -70 (2 Mbps, BER 0.01%) TYP.: -70 (3 Mbps, BER 0.01%)
Security	WEP TKIP AES	by driver software
Interface	SPI/SDIO	PCM (64 kbps), SPI/UART

Consult separately regarding driver software.

Notice

In the absence of confirmation by device specification sheets, SHARP takes no responsibility for any defects that may occur in equipment using any SHARP devices shown in catalogs, data books, etc. Contact SHARP in order to obtain the latest device specification sheets before using any SHARP device.



■ Infrared Data Communication Device Lineup

Communication system	Transmission speed	Transmission distance	Features	Operating supply voltage	Model No.
IrDA data (IrDA 1.x)	FIR 4 Mb/s (Receiver only)	250 cm		3.0 to 3.6 V	GP2W4020XPMF
		150 cm		3.0 to 3.6 V	GP2W4010YP0F
	FIR 4 Mb/s (Integrated receiver and transmitter type)	100/20 cm	LP/MP/HP mode switching function	2.7 to 5.5 V	GP2W1001YP0F▲
		35/21 cm	LP/HP mode switching function, remote control transmission function, thin (height: 1.5 mm)	2.6 to 3.6 V	GP2W3152YP0F
			LP/HP mode switching function, remote control transmission function, top view type (height: 1.75 mm)	2.6 to 3.6 V	GP2W3176XP0F
			LP/HP mode switching and remote control transmission functions	2.6 to 3.6 V	GP2W3120YP0F
		21 cm	LP/HP mode switching function	2.6 to 3.6 V	GP2W1320YP0F
		70/21 cm	LP/MP/HP mode switching and remote control transmission functions	2.6 to 3.3 V	GP2W3106YP0F
	SIR 115.2 kb/s (Integrated receiver and transmitter type)	100 cm	Compact, low dissipation current	2.4 to 5.5 V	GP2W0004YP0F▲/ GP2W0004XP0F▲
	SIR LP 115.2 kb/s (Integrated receiver and transmitter type)	21 cm	Built-in LED constant current circuit, 3-state output	2.0 to 3.6 V 1.7 to 2.5 V	GP2W0110VY GP2W0112VY

The model marked with ▲ may not be available in the near future. Contact with SHARP for details before use.



■ Infrared Data Communication Devices

◆ FIR Compliant Devices (Receiver Only)

Model No.	Communication system	Transmission speed	Description	Maximum reception distance*1 (cm)	Supply voltage (V DC)	Outline dimensions (mm)
GP2W4020XPMF	Uni-directional communication (receiving only)	4 Mb/s	IrSS™-compliant, receiving-only type	250	3 to 3.6	20.96 × 6.68 × 7.1
GP2W4010YP0F	Uni-directional communication (receiving only)	9.6 k to 4 Mb/s	IrSS™-compliant, receiving-only type	150	3 to 3.6	10 × 3.93 × 4.53

*1 Radiant intensity at transmitting side: 100 mW/sr



◆ FIR Compliant Devices (Integrated Receiver and Transmitter Type)

Model No.	Communication system	Transmission speed	Description	Transmission distance (cm)	Supply voltage (V DC)	Outline dimensions (mm)
GP2W3152YP0F	Bi-directional (half-duplex) communication	9.6 k to 4 Mb/s	With remote control transmission function, LP/HP mode switching function	21/35	2.6 to 3.6	7.88 × 2.76 × 1.5
GP2W3176XP0F	Bi-directional (half-duplex) communication	9.6 k to 4 Mb/s	With remote control transmission function, top-view, LP/HP mode switching function	21/35	2.7 to 3.6	8.72 × 2.53 × 1.75
GP2W3120YP0F	Bi-directional (half-duplex) communication	9.6 k to 4 Mb/s	With remote control transmission function, LP/HP mode switching function	21/35	2.6 to 3.6	7.16 × 2.73 × 1.82
GP2W1001YP0F▲	Bi-directional (half-duplex) communication	9.6 k to 4 Mb/s	LP/MP/HP mode switching function	20/100	2.7 to 5.5	10.01 × 4.38 × 3.53
GP2W1320YP0F	Bi-directional (half-duplex) communication	9.6 k to 4 Mb/s	Compact, thin, low dissipation current (Icc: TYP. 0.45 mA)	21	2.6 to 3.6	7.16 × 2.73 × 1.82
GP2W3106YP0F	Bi-directional (half-duplex) communication	9.6 k to 4 Mb/s	With remote control transmission function, LP/MP/HP mode switching function	21/70	2.6 to 3.3	7.9 × 2.85 × 2.5

The model marked with ▲ may not be available in the near future. Contact with SHARP for details before use.

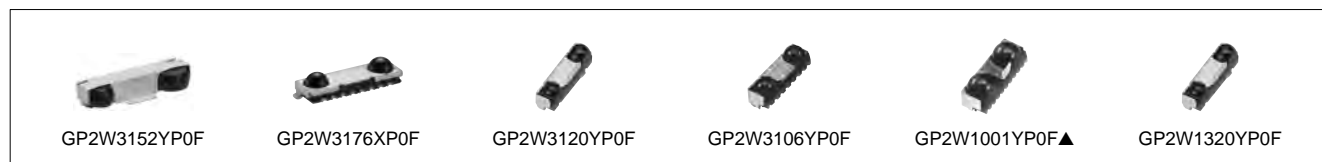

Notice

In the absence of confirmation by device specification sheets, SHARP takes no responsibility for any defects that may occur in equipment using any SHARP devices shown in catalogs, data books, etc. Except where specially indicated, models listed on this page comply with the RoHS Directive*. For details, please contact SHARP. *RoHS Directive: Prohibits use of lead, cadmium, hexavalent chromium, mercury and specific brominated flame retardants (PBBs and PBDEs), with certain exceptions. Contact SHARP in order to obtain the latest device specification sheets before using any SHARP device.



◆SIR Compliant Devices (Integrated Receiver and Transmitter Type)

Model No.	Communication system	Transmission speed	Description	Transmission distance (cm)	Supply voltage (V DC)	Outline dimensions (mm)
GP2W0004YP0F▲	Bi-directional (half-duplex) communication	9.6 k to 115.2 kb/s	Low dissipation current (I _{cc} : 130 μA MAX.)	100	2.4 to 5.5	9.21 × 3.76 × 2.71
GP2W0004XP0F▲	Bi-directional (half-duplex) communication	9.6 k to 115.2 kb/s	Low dissipation current (I _{cc} : 130 μA MAX.), top-view	100	2.4 to 5.5	9.21 × 3.35 × 3.8

The model marked with ▲ may not be available in the near future. Contact with SHARP for details before use.

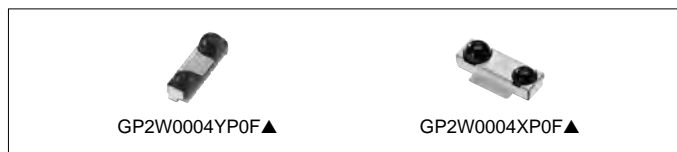

◆SIR LP Compliant Devices (Integrated Receiver and Transmitter Type)

Model No.	Communication system	Transmission speed	Description	Transmission distance (cm)	Supply voltage (V DC)	Outline dimensions (mm)
GP2W0110VY	Bi-directional (half-duplex) communication	2.4 k to 115.2 kb/s	Low dissipation current (I _{cc} : 120 μA MAX.)	21	2.0 to 3.6	6.8 × 2.35 × 2.1
GP2W0112VY	Bi-directional (half-duplex) communication	2.4 k to 115.2 kb/s	Low dissipation current (I _{cc} : 120 μA MAX.)	21	1.7 to 2.5	6.8 × 2.35 × 2.1



Notice

In the absence of confirmation by device specification sheets, SHARP takes no responsibility for any defects that may occur in equipment using any SHARP devices shown in catalogs, data books, etc.
 Except where specially indicated, models listed on this page comply with the RoHS Directive*. For details, please contact SHARP.
 *RoHS Directive: Prohibits use of lead, cadmium, hexavalent chromium, mercury and specific brominated flame retardants (PBBs and PBDEs), with certain exceptions.
 Contact SHARP in order to obtain the latest device specification sheets before using any SHARP device.



IR Detecting Unit for Remote Control Lineup (Classified by Form)

Type	Package		Features	Model No.		
	Form	Detection position*5 (from PCB)		Operating voltage: 3 to 5 V	Operating voltage: 5 V	Operating voltage: 3 to 5 V
IR detecting unit for remote control	Compact, thin type SMD (4.5 × 5.0 × 1.35 t mm)					GP1USC3xXP series
	Compact type SMD (6.8 × 2.1 × 2.35 t mm)					GP1UF31 series
	Lead L bend with shield case (holder)	16.0 mm*1	Compact size	GP1UE28XK0VF series	GP1UM28XK0VF series	GP1UE28xXKC4 series
		12.0 mm*2	Compact size, Strengthened resistance to electromagnetic induction noise (Mesh type)	GP1UE28RK0VF series	GP1UM28RK0VF series	GP1UE28xRKC4 series
			Compact size	GP1UE27XK0VF series	GP1UM27XK0VF series	GP1UE27xXKC4 series
		6.8 mm*3	Compact size, Strengthened resistance to electromagnetic induction noise (Mesh type)	GP1UE27RK0VF series	GP1UM27RK0VF series	GP1UE27xRKC4 series
	Compact size		GP1UE26XK0VF series	GP1UM26XK0VF series	GP1UE26xXKC4 series	
	Lead straight with shield case (holder)	19.0 mm	Compact size, Strengthened resistance to electromagnetic induction noise (Mesh type)	GP1UE29QK0VF series	GP1UM29QK0VF series	GP1UE29xQKC4 series
			Compact size	GP1UE28YK0VF series	GP1UM28YK0VF series	GP1UE28xYKC4 series
		9.6 mm	Compact size, Strengthened resistance to electromagnetic induction noise (Mesh type)	GP1UE28QK0VF series	GP1UM28QK0VF series	GP1UE28xQKC4 series
	Holderless	Lead straight 6.0 mm		GP1UX31QS series	GP1UX51QS series	GP1UXC4xQS series
		Lead L bend*4 5.3 mm		GP1UX31RK series	GP1UX51RK series	GP1UXC4xRK series

*1 Mesh type (strengthened resistance to electromagnetic induction noise): 16.4 mm
 *2 Mesh type: 12.4 mm *3 Mesh type: 7.2 mm *4 Mesh type: 5.3 mm
 *5 Lead straight: Distance from lens center to mounting board upper surface
 No mesh lead L bend: Distance from tip of lens to mounting board upper surface
 Mesh-type lead L bend: Distance from tip of mesh to mounting board upper surface

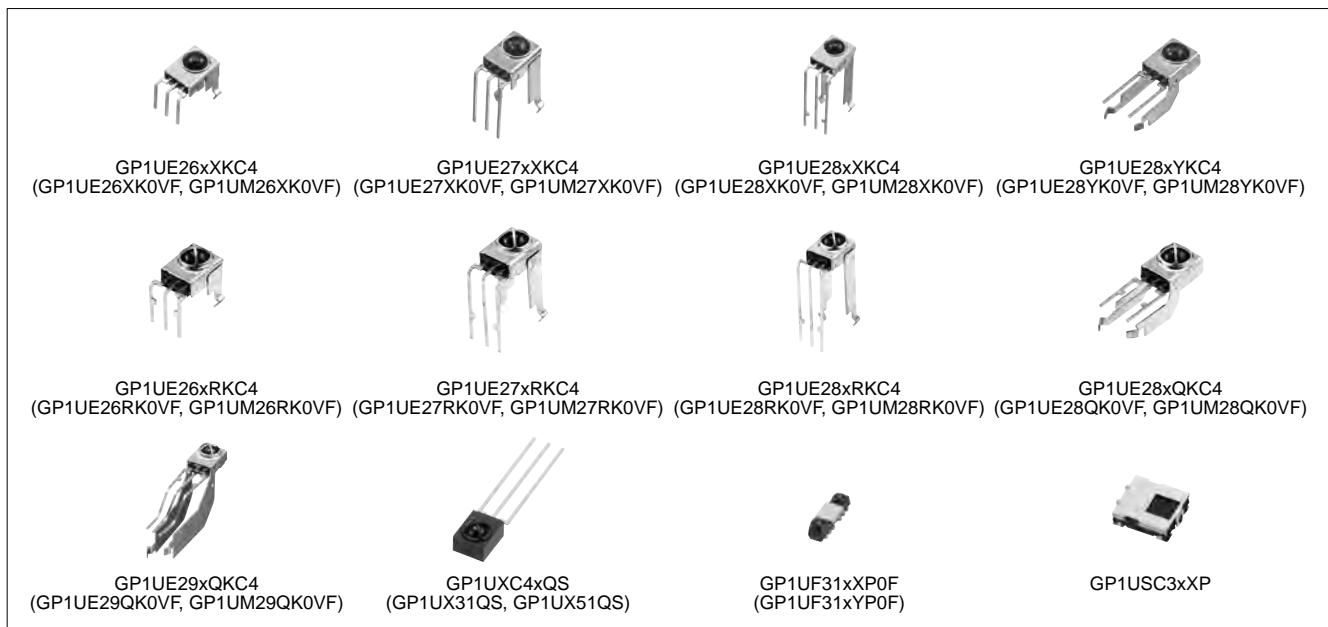



IR Detecting Units for Remote Control

(Ta = 25°C)

Type	Series No.	Absolute maximum ratings		Operating voltage (V)	Electrical characteristics				Size (mm)	Terminal layout
		Vcc (V)	To _{pr} (°C)		I _{cc} (mA) *1 MAX.	V _{OH} (V) MIN.	V _{OL} (V) MAX.	f _o (kHz) TYP.		
Surface-mount type, Reflow soldering compatible	GP1UF31xXPOF/ *5 GP1UF31xYPOF	0 to 6.0	-30 to +85	2.7 to 5.5	0.4	V _{cc} -0.5	0.45	*4	6.8 × 2.1 × 2.35	-
	GP1USC3xXP	0 to 6.0	-30 to +85	2.7 to 5.5	0.6	V _{cc} -0.5	0.45	*3	5 × 4.5 × 1.3	-
With shield case (holder), 3 to 5 V drive (New type)	GP1UE26xXKC4	0 to 6.0	-10 to +70	2.7 to 5.5	0.6	V _{cc} -0.5	0.45	*3	5.6 × 9.6 × 6.8	Center Vcc
	GP1UE27xXKC4	0 to 6.0	-10 to +70	2.7 to 5.5	0.6	V _{cc} -0.5	0.45	*3	5.6 × 9.6 × 12.0	
	GP1UE28xXKC4	0 to 6.0	-10 to +70	2.7 to 5.5	0.6	V _{cc} -0.5	0.45	*3	5.6 × 9.6 × 16.0	
	GP1UE28xYKC4	0 to 6.0	-10 to +70	2.7 to 5.5	0.6	V _{cc} -0.5	0.45	*3	5.6 × 8.6 × 12.5(9.6)*2	
With shield case (holder), 3 to 5 V drive, Strengthened resistance to electromagnetic induction noise (New type)	GP1UE26xRKC4	0 to 6.0	-10 to +70	2.7 to 5.5	0.6	V _{cc} -0.5	0.45	*3	5.6 × 9.6 × 7.2	
	GP1UE27xRKC4	0 to 6.0	-10 to +70	2.7 to 5.5	0.6	V _{cc} -0.5	0.45	*3	5.6 × 9.6 × 12.4	
	GP1UE28xRKC4	0 to 6.0	-10 to +70	2.7 to 5.5	0.6	V _{cc} -0.5	0.45	*3	5.6 × 9.6 × 16.4	
	GP1UE28xQKC4	0 to 6.0	-10 to +70	2.7 to 5.5	0.6	V _{cc} -0.5	0.45	*3	5.6 × 9.0 × 12.5(9.6)*2	
With shield case (holder), 5 V drive	GP1UE29xQKC4	0 to 6.0	-10 to +70	2.7 to 5.5	0.6	V _{cc} -0.5	0.45	*3	5.6 × 16.2 × 21.9(19)*2	
	GP1UM26XK0VF	0 to 6.0	-10 to +70	4.5 to 5.5	0.6 (0.65)	V _{cc} -0.5	0.45	*3	5.6 × 9.6 × 6.8	
	GP1UM27XK0VF	0 to 6.0	-10 to +70	4.5 to 5.5	0.6 (0.65)	V _{cc} -0.5	0.45	*3	5.6 × 9.6 × 12.0	
	GP1UM28XK0VF	0 to 6.0	-10 to +70	4.5 to 5.5	0.6 (0.65)	V _{cc} -0.5	0.45	*3	5.6 × 9.6 × 16.0	
	GP1UM28YK0VF	0 to 6.0	-10 to +70	4.5 to 5.5	0.6 (0.65)	V _{cc} -0.5	0.45	*3	5.6 × 8.6 × 12.5(9.6)*2	
With shield case (holder), 5 V drive, Strengthened resistance to electromagnetic induction noise	GP1UM26RK0VF	0 to 6.0	-10 to +70	4.5 to 5.5	0.6 (0.65)	V _{cc} -0.5	0.45	*3	5.6 × 9.6 × 7.2	
	GP1UM27RK0VF	0 to 6.0	-10 to +70	4.5 to 5.5	0.6 (0.65)	V _{cc} -0.5	0.45	*3	5.6 × 9.6 × 12.4	
	GP1UM28RK0VF	0 to 6.0	-10 to +70	4.5 to 5.5	0.6 (0.65)	V _{cc} -0.5	0.45	*3	5.6 × 9.6 × 16.4	
	GP1UM28QK0VF	0 to 6.0	-10 to +70	4.5 to 5.5	0.6 (0.65)	V _{cc} -0.5	0.45	*3	5.6 × 9.0 × 12.5(9.6)*2	
	GP1UM29QK0VF	0 to 6.0	-10 to +70	4.5 to 5.5	0.6 (0.65)	V _{cc} -0.5	0.45	*3	5.6 × 16.2 × 21.9(19)*2	
With shield case (holder), 3 to 5 V drive	GP1UE26XK0VF	0 to 6.0	-10 to +70	2.7 to 5.5	0.4	V _{cc} -0.5	0.45	*3	5.6 × 9.6 × 6.8	Center GND
	GP1UE27XK0VF	0 to 6.0	-10 to +70	2.7 to 5.5	0.4	V _{cc} -0.5	0.45	*3	5.6 × 9.6 × 12.0	
	GP1UE28XK0VF	0 to 6.0	-10 to +70	2.7 to 5.5	0.4	V _{cc} -0.5	0.45	*3	5.6 × 9.6 × 16.0	
	GP1UE28YK0VF	0 to 6.0	-10 to +70	2.7 to 5.5	0.4	V _{cc} -0.5	0.45	*3	5.6 × 8.6 × 12.5(9.6)*2	
With shield case (holder), 3 to 5 V drive, Strengthened resistance to electromagnetic induction noise	GP1UE26RK0VF	0 to 6.0	-10 to +70	2.7 to 5.5	0.4	V _{cc} -0.5	0.45	*3	5.6 × 9.6 × 7.2	
	GP1UE27RK0VF	0 to 6.0	-10 to +70	2.7 to 5.5	0.4	V _{cc} -0.5	0.45	*3	5.6 × 9.6 × 12.4	
	GP1UE28RK0VF	0 to 6.0	-10 to +70	2.7 to 5.5	0.4	V _{cc} -0.5	0.45	*3	5.6 × 9.6 × 16.4	
	GP1UE28QK0VF	0 to 6.0	-10 to +70	2.7 to 5.5	0.4	V _{cc} -0.5	0.45	*3	5.6 × 9.0 × 12.5(9.6)*2	
	GP1UE29QK0VF	0 to 6.0	-10 to +70	2.7 to 5.5	0.4	V _{cc} -0.5	0.45	*3	5.6 × 16.2 × 21.9(19)*2	
Holderless, 3 to 5 V drive, Strengthened resistance to electromagnetic induction noise (New type)	GP1UXC4xQS	0 to 6.0	-10 to +70	2.7 to 5.5	0.6	V _{cc} -0.5	0.45	*3	5.5 × 5.3 × 7.5	
	GP1UXC4xRK	0 to 6.0	-10 to +70	2.7 to 5.5	0.6	V _{cc} -0.5	0.45	*3	5.5 × 5.3 × 7.5	
Holderless, 5 V drive, Strengthened resistance to electromagnetic induction noise	GP1UX51QS	0 to 6.0	-10 to +70	4.5 to 5.5	0.6	V _{cc} -0.5	0.45	*3	5.5 × 5.3 × 7.5	
	GP1UX51RK	0 to 6.0	-10 to +70	4.5 to 5.5	0.6	V _{cc} -0.5	0.45	*3	5.5 × 5.3 × 7.5	
Holderless, 3 to 5 V drive, Strengthened resistance to electromagnetic induction noise	GP1UX31QS	0 to 6.0	-10 to +70	4.5 to 5.5	0.4	V _{cc} -0.5	0.45	*3	5.5 × 5.3 × 7.5	
	GP1UX31RK	0 to 6.0	-10 to +70	4.5 to 5.5	0.4	V _{cc} -0.5	0.45	*3	5.5 × 5.3 × 7.5	

* A voltage regulator circuit is built-in but may be affected by the usage environment. Install with an externally mounted C and R as a power supply filter.

*1 When no signal is input (during input light).

*2 Figures in parentheses indicate the distance to the light detection center.

*3 fo = 32.75/36/36.7/38/40 kHz

*4 fo = 36/36.7/38/40 kHz

*5 GP1UF31xXPOF: Top view taped package,
GP1UF31xYPOF: Side view taped package

Notice

In the absence of confirmation by device specification sheets, SHARP takes no responsibility for any defects that may occur in equipment using any SHARP devices shown in catalogs, data books, etc.

Except where specially indicated, models listed on this page comply with the RoHS Directive*. For details, please contact SHARP. *RoHS Directive: Prohibits use of lead, cadmium, hexavalent chromium, mercury and specific brominated flame retardants (PBBs and PBDEs), with certain exceptions.

Contact SHARP in order to obtain the latest device specification sheets before using any SHARP device.



■ Advanced Flex Printed Circuit Boards <Multilayer FPC specifications>

The advanced flex printed circuit board is a multilayered wiring board comprising of flexible printed circuits (FPC) laminated into a multilayer configuration. The PWBs and FPCs are connected to each other via copper-plated through holes. It is ideal for compact, lightweight equipment design.

◆ Features

- (1) For selecting optimal specifications to suit specific applications, special specifications such as for mobile phones are also available.
 - Minimum thickness in multi-layer part: 0.19 mm (4-layer), 0.33 mm (6-layer)
 - Minimum pattern width/pitch: 0.06/0.07 mm
 - Flexibility of single/double sided FPC part (dedicated for hinge): More than 200 000 times 180-degree bending of radius 3 mm
- (2) Capable of board-to-board connection without connectors, which enables space-saving and 3-dimensional equipment assembly.
- (3) Through hole plating connection of multi-layer (3 to 8) part to flexible part significantly improves reliability.
- (4) Blind Via Hole (BVH) forming with laser via drilling of small diameter.
- (5) Sheet design provides excellent mountability, equivalent to that of PWB.

◆ Outline Specifications

Type	Folding type/Flying tail type	
Min. base thickness (mm)	0.19 (4-layer), 0.33 (6-layer), 0.40 (8-layer)	
Min. line width/spacing (mm)	0.05/0.05	
Min. through hole diameter (mm)	ø0.25	
Min. via hole land diameter	Through hole (mm)	Outer layer: ø0.5, Inner layer: ø0.5
	Blind via hole (mm)	ø0.09
	Inner via hole (mm)	ø0.30
Solder resist	Multi layer: Liquid photo solder resist, FPC: Film cover ray	
Surface finish	Heat-resistant preflux, Ni-Au plating (Ni-Au plating for flying tail)	

■ Construction of Advanced Flex Board (example of 6-layer BVH)

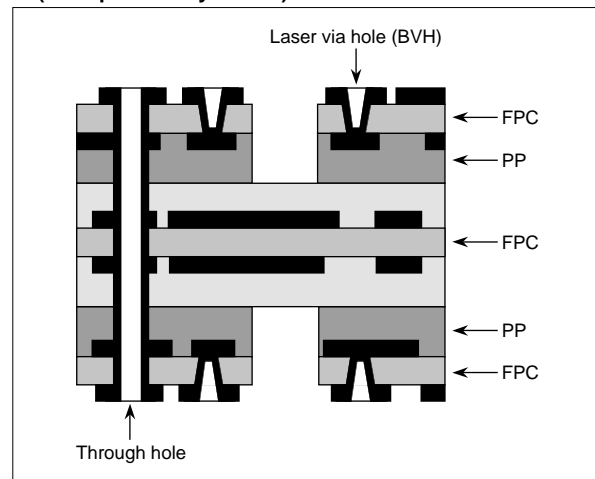

Notice

In the absence of confirmation by device specification sheets, SHARP takes no responsibility for any defects that may occur in equipment using any SHARP devices shown in catalogs, data books, etc. Contact SHARP in order to obtain the latest device specification sheets before using any SHARP device.



■ Advanced Flex Printed Circuit Boards <Flex-rigid specifications>

With rigid materials used for the build-up multilayer, this board can handle finer mounting patterns and achieve connectorless between-board connections using an inner layer flexible printed circuit (FPC). This facilitates greater equipment design flexibility and ultra-compact designs.

◆ Features

- (1) Multiple build-up layers are connected internally with an FPC, thereby improving connection reliability between multilayer boards and reducing both connection space and connector weight.
- (2) Enables narrow pitch (0.4 mm) CSP and bare chip mounting, and thus greater equipment compactness through ultra-high density mounting.
- (3) Enables via-on-IVH (inner-via-hole) configurations and stacked-via-hole configurations, and makes it possible to achieve ultra-high-density wiring designs. (Facilitates a diverse range of designs for greater compactness and thinness.)

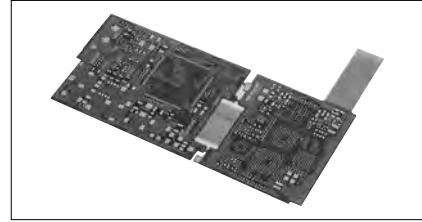

◆ Outline Specifications

Type	6- to 8-layer, flex-rigid	
FPC core layer configuration	2 to 6 layers (Polyimide)	
No. of build-up layers	1 to 2 layers for each side of core layer	
Min. board thickness (mm)	0.4 (6-layer), 0.53 (8-layer)	
Min. via hole diameter/ Land hole diameter	Conformal via hole (mm)	Hole: $\phi 0.09$ / Land: $\phi 0.25$
	Stacked via hole (mm)	Hole: $\phi 0.09$ / Land: $\phi 0.25$
Min. inner via hole diameter (mm)	Hole: $\phi 0.09$ / Land: $\phi 0.25$	
Via-on IVH	Available	
Min. line width/spacing (mm)	0.05/0.05	
CSP mountable pitch (mm)	0.4	

■ Construction of Advanced Flex Board (example of 6-layer IVH)

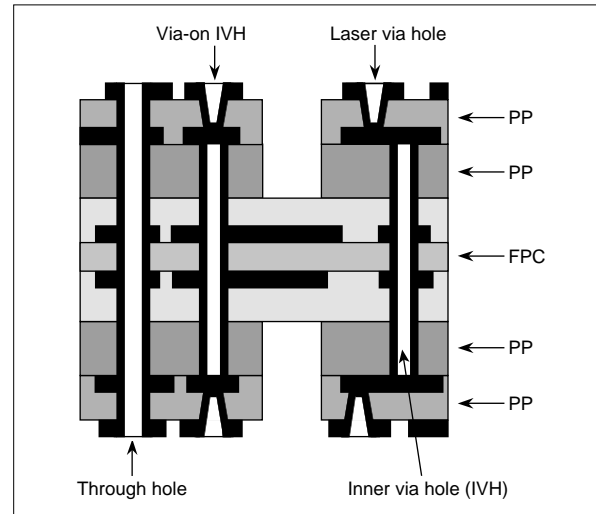

Notice

In the absence of confirmation by device specification sheets, SHARP takes no responsibility for any defects that may occur in equipment using any SHARP devices shown in catalogs, data books, etc. Contact SHARP in order to obtain the latest device specification sheets before using any SHARP device.



Flexible Printed Circuit Boards

The flexible printed circuit board is designed for high space efficiency and product design flexibility, which are now aiming at more compact and higher density mounting. It also contributes to the reduction of assembly process and to the enhancement of the reliability.

◆ Features

- (1) High density mounting circuit, SMT and other most suitable flexible PCB are available.
- (2) High precision type for COF with flip chip mounting and wire bonding capabilities and other connector mounting type are also available.

◆ Standard specifications

Layers	Single side	Both-side through-hole
Substrate materials	Polyimido film, non-adhesive polyimido	
Design pattern width (mm)	0.04 (MIN.)	0.05 (MIN.)
Design pattern spacing (mm)	0.04 (MIN.)	0.05 (MIN.)
Through-hole / land diameter (mm)	-	ø0.1/ø0.3 (MIN.)
Cover lay	Polyimido film, liquid soldering resist	
Safety standard	UL (94V-0)	

* Other specifications available are as follows.

Bonding Ni-Au plating
High density SMT



Notice

In the absence of confirmation by device specification sheets, SHARP takes no responsibility for any defects that may occur in equipment using any SHARP devices shown in catalogs, data books, etc. Contact SHARP in order to obtain the latest device specification sheets before using any SHARP device.

■ DVD Pickup for Automotive Use <HPD-61>

◆ Features

- Compact, thin (7.3 mm) pickup
- Playable disk: DVD-ROM, CD-ROM
- Operating temperature: -20 to +80°C
- Outline dimensions: W 30.2 × H 7.3 × D 48.7 (mm)
- Weight: Approx. 13.5 g

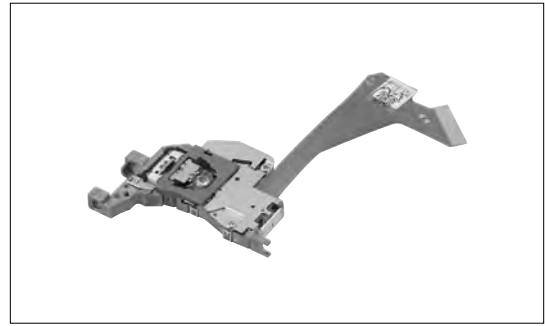

Notice

In the absence of confirmation by device specification sheets, SHARP takes no responsibility for any defects that may occur in equipment using any SHARP devices shown in catalogs, data books, etc. Contact SHARP in order to obtain the latest device specification sheets before using any SHARP device.

BS

BS1F6JP100A.....	90
BS1F6JU300A.....	90
BS1F9JU300A.....	90
BS1K0EL150A.....	89
BS1K0EL250A.....	89
BS1R8AR100A.....	90
BS1R8EL400A.....	89
BS1R8EL500A.....	89
BS2F7HZ1266.....	91
BS2F7VZ7702.....	91
BS2S7HZ6903.....	91
BS2S7HZ7903.....	91

DC

DC2K1DZ172.....	97
-----------------	----

DU

DU6F4JZxxxx.....	95
DU6N4JZxxxx.....	95
DU6R4JZxxxx.....	96
DU6U4JZxxxx.....	95

GA

GA1A1S100WP.....	67
GA1A1S202WP.....	67
GA1A1S203WP.....	67
GA1A1S204WP.....	67
GA1A2S100LY.....	67
GA1A2S100SS.....	67
GA220T2L2IZ.....	69

GH

GH04020C4A.....	87/88
GH04020D2A.....	87/88

GH04P32A2G.....	87/88
GH04P32A4G.....	87/88
GH04P43A2G.....	87/88
GH04P43A4G.....	87/88
GH06510F2B.....	87
GH06510F4A.....	87
GH06P30C1C.....	87/88
GH07815D2K.....	87
GH07825D2K.....	87
GH07P28F1C.....	87/88
GH07P28F4C.....	87/88
GH16P35A8C.....	87/88
GH33540A8C.....	87/88
GH3S215D2B.....	87
GH3S225D2B.....	87

GL

GL100MD1MP1.....	73
GL100MN0MP.....	73
GL100MN1MP.....	73
GL4100E0000F.....	73
GL4800E0000F.....	73
GL480E00000F.....	73

GM1

GM1BC35372AC.....	81
GM1EG55200A.....	81
GM1GC35370AC.....	81
GM1HD55200A.....	81
GM1HS55200A.....	81
GM1HY55200A.....	81
GM1JE35200AE.....	81
GM1JE55200AE.....	81
GM1JJ35200AE.....	81
GM1JJ55200AE.....	81
GM1JR35200AE.....	81

GM1JR55200AE.....	81
GM1JS35200AE.....	81
GM1JS55200AE.....	81
GM1JV35200AE.....	81
GM1JV55200AE.....	81
GM1WA55311A.....	82

GM2

GM2BB0CH10A.....	86
GM2BB27QK0C.....	85
GM2BB27QKAC.....	85
GM2BB30QK0C.....	85
GM2BB30QKAC.....	85
GM2BB35QK0C.....	85
GM2BB35QKAC.....	85
GM2BB40QK0C.....	85
GM2BB40QKAC.....	85
GM2BB45QK0C.....	85
GM2BB45QKAC.....	85
GM2BB50QK0C.....	85
GM2BB50QKAC.....	85
GM2BB57QK0C.....	85
GM2BB65QK0C.....	85
GM2BB65QKAC.....	85

GM4

GM4BN653C0A.....	82
GM4BW653A0A.....	82
GM4BW653B0A.....	82
GM4BW853A0A.....	82
GM4BW853B0A.....	82
GM4WA25300A.....	82

GM5

GM5BN97330A.....	82
------------------	----

GM5BW94370A.....	82
GM5BW96382A.....	82
GM5BW96385A.....	82
GM5BW96387A.....	82
GM5BW97330A.....	82
GM5BW97332A.....	82
GM5BW97333A.....	82
GM5FM0CP10A.....	86
GM5SAE27P0A.....	85
GM5SAE30P0A.....	85
GM5SAE35P0A.....	85
GM5SAE40P0A.....	85
GM5SAE45P0A.....	85
GM5SAE50P0A.....	85
GM5SAE57P0A.....	85
GM5SAE65P0A.....	85
GM5WA94315A.....	85
GM5WA94320A.....	82
GM5ZR96270A.....	81
GM5ZV96270A.....	81

GP1

GP1A054RDKLF.....	64
GP1A057RBKLF.....	64
GP1A057SGKLF.....	64
GP1A058SCK0F.....	64
GP1A073LCS.....	62
GP1A101C2KSF.....	64
GP1A173LCS2F.....	62
GP1A173LCSVF.....	62
GP1A204HCS0.....	64
GP1A273LCS1F.....	62
GP1A50HRJ00F.....	61
GP1A51HRJ00F.....	61
GP1A52HRJ00F.....	61
GP1A52LRJ00F.....	61

GP1A53HRJ00F..... 61	GP1S195HCPSF 58	GP1UF31xXP0F.....102	GP2S700HCP 62
GP1A57HRJ00F..... 61	GP1S195HCZSF 58	GP1UF31xYP0F.....102	GP2TC2J0000F..... 78
GP1A58HRJ00F..... 61	GP1S196HCPSF 58	GP1UM26RK0VF.....102	GP2W0004XP0F..... 100
GP1A73AJ000F..... 62	GP1S196HCZ0F 58	GP1UM26XK0VF102	GP2W0004YP0F..... 100
GP1A75EJ000F..... 62	GP1S196HCZSF 58	GP1UM27RK0VF102	GP2W0110VY 100
GP1A98HCPSF..... 60	GP1S273LCS1F 59	GP1UM27XK0VF102	GP2W0112VY 100
GP1A98HCZ0F 60	GP1S296HCPSF 58	GP1UM28QK0VF.....102	GP2W1001YP0F..... 99
GP1FAV30RK0F..... 80	GP1S396HCP0F..... 58	GP1UM28RK0VF102	GP2W1320YP0F..... 99
GP1FAV30TK0F 80	GP1S396HCPSF 58	GP1UM28XK0VF102	GP2W3106YP0F..... 99
GP1FAV31RK0F..... 80	GP1S50J0000F 59	GP1UM28YK0VF102	GP2W3120YP0F..... 99
GP1FAV31TK0F 80	GP1S51VJ000F 59	GP1UM29QK0VF102	GP2W3152YP0F..... 99
GP1FAV50RK0F..... 80	GP1S52VJ000F 59	GP1USC3xXP102	GP2W3176XP0F..... 99
GP1FAV50TK0F 80	GP1S53VJ000F 59	GP1UX31QS.....102	GP2W4010YP0F..... 99
GP1FAV51RK0F..... 80	GP1S54J0000F 59	GP1UX31RK.....102	GP2W4020XPMF..... 99
GP1FAV51TK0F 80	GP1S56TJ000F 59	GP1UX51QS.....102	GP2Y0A02YK0F..... 76
GP1FAV55TK0F 80	GP1S58VJ000F 59	GP1UX51RK.....102	GP2Y0A21YK0F..... 76
GP1FD320TP0F..... 80	GP1S59J0000F 59	GP1UXC4xQS.....102	GP2Y0A41SK0F..... 76
GP1FMV31RK0F..... 80	GP1S74PJ000F 59	GP1UXC4xRK.....102	GP2Y0A51SK0F..... 76
GP1FMV31TK0F..... 80	GP1UE26RK0VF 102		GP2Y0A60SZ0F..... 76
GP1FMV51RK0F..... 80	GP1UE26XK0VF 102	GP2	GP2Y0A60SZLF..... 76
GP1FMV51TK0F..... 80	GP1UE26xRKC4 102	GP2A200LCS0F.....63	GP2Y0A710K0F..... 76
GP1FSB31TK0F..... 80	GP1UE26xXKC4..... 102	GP2A222HCKA.....65	GP2Y0AH01K0F..... 77
GP1FSV31TK0F..... 80	GP1UE27RK0VF 102	GP2A230LRS0F.....63	GP2Y0D02YK0F..... 75
GP1FSV51TK0F..... 80	GP1UE27XK0VF 102	GP2A231LRSAF.....63	GP2Y0D21YK0F..... 75
GP1L50J0000F 60	GP1UE27xRKC4 102	GP2A240LCS0F.....63	GP2Y0D310K..... 75
GP1L51J0000F 60	GP1UE27xXKC4..... 102	GP2A250LCS0F.....63	GP2Y0D340K..... 75
GP1L52VJ000F 60	GP1UE28QK0VF 102	GP2A25DJ000F63	GP2Y0D413K0F..... 75
GP1L53VJ000F 60	GP1UE28RK0VF 102	GP2A25J0000F.....63	GP2Y0D805Z0F..... 75
GP1L57J0000F 60	GP1UE28XK0VF 102	GP2A25NJJ00F63	GP2Y0D810Z0F..... 75
GP1S092HCPIF 58	GP1UE28xQKC4 102	GP2A28AJ000F63	GP2Y0D810Z1F..... 75
GP1S093HCZ0F 58	GP1UE28xRKC4 102	GP2AP002A00F.....66	GP2Y1010AU0F..... 78
GP1S094HCZ0F 58	GP1UE28xXKC4..... 102	GP2AP002S00F.....65	GP2Y2A180K0F..... 77
GP1S096HCZ0F 58	GP1UE28xYKC4..... 102	GP2AP020A00F.....66	GP2Y2A280K0F..... 77
GP1S097HCZ0F 58	GP1UE28YK0VF 102	GP2D150AJ00F.....75	GP2Y2D160K0F..... 77
GP1S173LCS2F..... 59	GP1UE29QK0VF 102	GP2S29SVJ00F.....64	GP2Y3A001K0F..... 77
GP1S194HCZ0F 58	GP1UE29xQKC4 102	GP2S60.....62	GP2Y3A002K0F..... 77

GP2Y3A003K0F 77
 GP2Y40010K0F 78
 GP2Y5D91S00F 75

GW

GW5BMC27KG4 83
 GW5BMC30KG4 83
 GW5BMC40KG4 83
 GW5BMC50KG4 83
 GW5BMC65KG4 83
 GW5BMF27K04 83
 GW5BMF30K04 83
 GW5BMF40K04 83
 GW5BMF50K04 83
 GW5BMF65K04 83
 GW5BMJ27K04 83
 GW5BMJ30K04 83
 GW5BMJ40K04 83
 GW5BMJ50K04 83
 GW5BMJ65K04 83
 GW5DGA27M04 83
 GW5DGA30M04 83
 GW5DGA40M04 83
 GW5DGA50M04 83
 GW5DGA65M04 83
 GW5DGC27M04 84
 GW5DGC30M04 84
 GW5DGC40M04 84
 GW5DGC50M04 84
 GW5DGC65M04 84
 GW5DGE27MR5 84
 GW5DGE30MR5 84
 GW5DGE40MR5 84
 GW5DGE50M05 84
 GW5DGE65M05 84
 GW5DLA40M04 83

GW5DLA50M04 83
 GW5DLA65M04 83
 GW5DLC40M04 84
 GW5DLC50M04 84
 GW5DLC65M04 84
 GW5DLE40MR5 84
 GW5DLE50M05 84
 GW5DLE65M05 84
 GW5DMA27M04 83
 GW5DMA30M04 83
 GW5DMC27M04 84
 GW5DMC30M04 84
 GW5DME27MR5 84
 GW5DME30MR5 84

HPD

HPD-61 106

IR2

IR2D071 29
 IR2D20U 29
 IR2E49M 28
 IR2E49U 28
 IR2E56U6 28
 IR2E58U 28
 IR2E63Yx 28
 IR2E65U 29
 IR2E67M 29
 IR2E68Yx 28

IR3

IR3M58M 18
 IR3M58U 18
 IR3M59U 12/27
 IR3M63U 12/13/27
 IR3M85N4 30

IR3T46U6 31
 IR3T48Y6 31

IRM

IRM053U7 30
 IRM065U7 30
 IRM067U6 30
 IRM068U7 30

IS

IS471FE 68
 IS485E 68
 IS486E 68
 IS489E 68

LH

LH163Y 17
 LH16DD 17
 LH16DE 17
 LH16DH 17
 LH16DK 17

LK

LK600D3LB14 7
 LK601R3LA19 7
 LK816D3LA19 7

LQ0

LQ035Q3DG03 6
 LQ043T3DG01 6
 LQ043T3DG02 6
 LQ043T3DW03 6
 LQ057Q3DC03 6
 LQ057V3LG11 6
 LQ070Y3DG3A 6
 LQ070Y3DG3B 6

LQ070Y3LG4A 6
 LQ070Y3LW01 6
 LQ084S3LG03 6
 LQ084V3DG02 6

LQ1

LQ104V1DG81 6
 LQ104V1LG81 6
 LQ121S1LG81 6
 LQ121S1LG84 6
 LQ150X1LG91 6
 LQ190E1LW52 6
 LQ190E1LX51 6

LQ2

LQ231U1LW32 6

LQ3

LQ315D1LG91 7

LR0

LR0G934 19
 LR0G938 19
 LR0GC023 31
 LR0GC05 31

LR3

LR35501 19/20
 LR35503 19/20
 LR366851 12
 LR36B03A 12/15/16
 LR36B14 12/14
 LR36B15 12
 LR38627 12/15
 LR38653 12/13
 LR38654 12/13

LR38690A..... 12/16
 LR388D1 18/21
 LR388D8 18/21
 LR388G9 18/21
 LR388H0 17
 LR388H3 17
 LR388J4 18/21

PC1

PC1231xNSZ0X 46
 PC123XNNSZ0F 46
 PC1S3021NTZF 52
 PC1S3052NTZF 52
 PC1S3063NTZF 52

PC2

PC2SD11NTZAF 51

PC3

PC352NJ0000F 44
 PC354NJ0000F 44
 PC355NJ0000F 44
 PC357NJ0000F 44
 PC364NJ0000F 44
 PC365NJ0000F 44
 PC367NJ0000F 44
 PC3H2J00000F 45
 PC3H3J00000F 45
 PC3H41xNIP0F 45
 PC3H4J00000F 45
 PC3H510NIP0F 45
 PC3H5J00000F 45
 PC3H71xNIP0F 45
 PC3H7J00000F 45
 PC3HU7xYIP0B 45
 PC3SD11NTZCF 51

PC3SD12NTZAF 51
 PC3SD12NTZBF 51
 PC3SD21NTZAF 52
 PC3SD21NTZBF 52
 PC3SD21NTZCF 52
 PC3SD21NTZDF 52
 PC3SD23YTZCF 52
 PC3SF11YVZAF 51
 PC3SF11YVZBF 51

PC3SF13YVZBF 51
 PC3SF21YVZAF 52
 PC3SF21YVZBF 52
 PC3SH11YFZAX 51
 PC3SH13YFZAX 51
 PC3SH21YFZBX 52
 PC3ST11NSZAX 51
 PC3ST21NSZBX 52

PC4

PC400J00000F 48
 PC410L0NIP0F 48
 PC410S0NIP0F 48
 PC451J00000F 44
 PC452J00000F 44
 PC456L0NIP0F 48
 PC457L0NIP0F 48
 PC457S0NIP0F 48
 PC4D10SNIP0F 48
 PC4SD11NTZBF 51
 PC4SD11NTZCF 51
 PC4SD21NTZCF 52
 PC4SD21NTZDF 52
 PC4SF11YVZAF 51
 PC4SF11YVZBF 51
 PC4SF21YVZBF 52
 PC4SF21YVZCF 52

PC7

PC713V0NSZXF 47
 PC714V0NSZXF 47
 PC715V0NSZXF 47
 PC724V0NSZXF 47
 PC725V0NSZXF 47

PC8

PC81510NSZ0X 46
 PC815XNNSZ0F 46
 PC8171xNSZ0X 46
 PC817XNNSZ0F 46
 PC851XNNSZ0F 46
 PC852XNNSZ0F 46
 PC853XNNSZ0F 46

PC9

PC900V0NSZXF 49
 PC925LxNSZ0F 49
 PC928J00000F 49
 PC929J00000F 49
 PC942J00000F 49

PD

PD100MC0MP 72
 PD100MF0MP 72
 PD410PI2E00F 72
 PD411PI2E00F 72
 PD412PI2E00F 72
 PD413PI2E00F 72

PQ0

PQ035ZN01ZPH 23
 PQ035ZN1HZPH 23
 PQ070VK01FZH 22

PQ070VK02FZH 22
 PQ070XF01SZH 22
 PQ070XHA2ZPH 24
 PQ070XNA1ZPH 23
 PQ070XNA2ZPH 23
 PQ070XNAHZPH 23
 PQ070XNB1ZPH 23

PQ1

PQ150RWA2SZH 22
 PQ1AS1D01 30
 PQ1AS1D01A 30
 PQ1AS2D01 30
 PQ1CG2032FZH 26
 PQ1CG2032RZH 26
 PQ1CG21H2FZH 26
 PQ1CG21H2RZH 26
 PQ1CG3032FZH 26
 PQ1CG3032RZH 26
 PQ1CG38M2FZH 26
 PQ1CG38M2RZH 26
 PQ1CG41H2FZH 26
 PQ1CG41H2RZH 26
 PQ1CN38M2ZPH 25
 PQ1CN41H2ZPH 25
 PQ1CX41H2ZPQ 25
 PQ1CX53H2MPQ 25
 PQ1CX61H1ZPQ 25
 PQ1CY1032ZPH 25
 PQ1CZ21H2ZPH 25
 PQ1DC15C0P 30
 PQ1DC15F1P 30
 PQ1DX095MZPQ 24
 PQ1DX125MZPQ 24
 PQ1LAX95MSPQ 22
 PQ1LAXx5MSPQ 22

PQ2

PQ200WN3MZPH 23
 PQ200WNA1ZPH 23

PQ3

PQ30RV11J00H 22
 PQ30RV21J00H 22
 PQ30RV31J00H 22

PQ5

PQ5CM03P 26

PQ6

PQ6CB11X1CP 28
 PQ6CU12X2APQ 25

PQ7

PQ7L2020BP 28
 PQ7L3010QPF 28

PQx

PQxxxDNA1ZPH series 23
 PQxxxENA1ZPH series 23
 PQxxxENAHZPH series 23
 PQxxxENB1ZPH series 23
 PQxxxGN01ZPH series 23
 PQxxxGN1HZPH series 23
 PQxxxRDA1SZH series 22
 PQxxxRDA2SZH series 22

PR

PR22MA11NTZF 54
 PR23MF11NSZF 54
 PR26MF11NSZF 54
 PR26MF12NSZF 54

PR26MF21NSZF 54
 PR29MF11NSZF 54
 PR29MF12NSZF 54
 PR29MF21NSZF 54
 PR31MA11NTZF 54
 PR32MA11NTZF 54
 PR33MF51NSZF 54
 PR36MF12NSZF 54
 PR36MF21NSZF 54
 PR36MF22NSZF 54
 PR36MF51NSZF 54
 PR39MF12NSZF 54
 PR39MF21NSZF 54
 PR39MF22NSZF 54
 PR39MF51NSZF 54
 PR3BMF21NSZF 54
 PR3BMF51NSKF 54

PT

PT100MC0MP 71
 PT100MF0MP 71
 PT100MF1MP 71
 PT4800E0000F 71
 PT4800FE000F 71
 PT480E00000F 71
 PT480FE0000F 71
 PT4810E0000F 71
 PT4810FJE00F 71
 PT481E00000F 71
 PT481FE0000F 71
 PT483F1E000F 71
 PT4850FE000F 71
 PT491FE0000F 71
 PT493FE0000F 71

QM

QM2A1UA003 30
 QM2A1UA004 30

RJ

RJ2311DB0PB 11/13/14/15/16
 RJ2315DB0PB 11/13/14/15/16
 RJ2321DB0PB 11/13/14/15/16
 RJ2325DB0PB 11/13/14/15/16
 RJ2331AA0PB 11
 RJ2341AA0PB 11
 RJ2351CA0PB 11/13/14/15/16
 RJ2355CA0PB 11/13/14/15/16
 RJ2361CA0PB 11/13/14/15/16
 RJ2365CA0PB 11/13/14/15/16
 RJ23E3BA0LT 10/11
 RJ23W3EA0KT 10/11
 RJ23W3HA0LT 10/11
 RJ23Y3BC0LT 10/11
 RJ23Y3EA0LT 10/11
 RJ23Y3HA0LT 10/11
 RJ23Z3BA0LT 10/11
 RJ2411CA0PB 11/13
 RJ2411EA0PB 11/13/14/15/16
 RJ2411EB0PB 11/13/14/15/16
 RJ2411FA0PB 11/13/14/15/16
 RJ2421EB0PB 11/13/14/15/16
 RJ2421FA0PB 11/13/14/15/16
 RJ2451CA0PB 11/13/14/15/16
 RJ2455CA0PB 11/13/14/15/16
 RJ2461CA0PB 11/13/14/15/16
 RJ2465CA0PB 11/13/14/15/16
 RJ3331AA0PB 11
 RJ3341AA0PB 11
 RJ63VC200 8/9

RJ63YC100 8/9
 RJ63YC200 8/9
 RJ64PC800 8/9
 RJ64SC100 8/9
 RJ64SC200 8/9
 RJ6CBA100 8/9
 RJ6CBA200 8/9

S1

S101S05F 55
 S101S06F 55
 S101S16F 55
 S102S01F 55
 S102S02F 55
 S102S11F 55
 S102S12F 55
 S102T01F 55
 S102T02F 55
 S108T01F 55
 S108T02F 55
 S112S01F 55
 S116S01F 55
 S116S02F 55

S2

S201S06F 56
 S202S01F 55
 S202S02F 56
 S202S11F 56
 S202S12F 56
 S202S15F 56
 S202T01F 55
 S202T02F 55
 S208T01F 55
 S208T02F 55
 S212S01F 55

S216S01F..... 55
S216S02F..... 56
S2S3000F..... 51
S2S4000F..... 52
S2S5A00F..... 51

VA

VA1N5JF8627..... 95
VA1P1CD8402..... 94
VA3A5JZ967..... 96
VA3D5JZ705..... 95
VA4A1BC5038..... 94
VA4D1JA2160..... 94/95
VA4M1DA5167..... 94
VA4M1EX6158..... 93
VA4M5JC2116..... 92/96
VA4M6JC2103..... 92/96
VA4N1BD1108..... 93
VA4N1CD1136..... 93
VA4S5DC5072..... 93

NOTICE

The circuit application examples in this publication are provided to explain representative applications of SHARP devices and are not intended to guarantee any circuit design or license any intellectual property right. SHARP takes no responsibility for any problems related to any intellectual property right of a third party resulting from the use of SHARP devices.

SHARP reserves the right to make changes in the specifications, characteristics, data, materials, structures and other contents described herein at any time without notice in order to improve design or reliability.

Contact SHARP in order to obtain the latest device specification sheets before using any SHARP device. Manufacturing locations are also subject to change without notice.

In the absence of confirmation by device specification sheets, SHARP takes no responsibility for any defects that occur in equipment using any SHARP devices shown in catalogs, data books, etc.

The devices listed in this publication are designed for standard applications for use in general electronic equipment. SHARP's devices shall not be used for or in connection with equipment that requires an extremely high level of reliability, such as military and aerospace applications, telecommunication equipment (trunk lines), nuclear power control equipment and medical or other life support equipment (e.g. Scuba). SHARP takes no responsibility for damage caused by improper use of device, which does not meet the conditions for use specified in the relevant specification sheet.

If the SHARP devices listed in the publication fall within the scope of strategic products described in the Foreign Exchange and Foreign Trade Law of Japan, it is necessary to obtain approval to export such SHARP devices.

This publication is the proprietary product of SHARP and is copyrighted, with all rights reserved. Under the copyright laws, no part of this publication may be reproduced or transmitted in any form or by any means, electronic or mechanical for any purpose, in whole or in part, without the express written permission of SHARP. Express written permission is also required before any use of this publication may be made by a third party.

Contact and consult with a SHARP representative if there are any questions about the contents of this publication.

U.S.A

SHARP MICROELECTRONICS OF THE AMERICAS

■ North American Head Office
5700 NW Pacific Rim Boulevard
Camas, WA 98607 USA
PHONE: +1-360-834-8700 FAX: +1-360-834-8903
http://www.sharpsma.com

■ Western Region

1980 Zanker Road San Jose, CA 95112
PHONE: +1-408-436-4900 FAX: +1-408-436-0924

■ Eastern Region

200 Wheeler Rd., Burlington, MA 01803
PHONE: +1-781-270-7979 FAX: +1-781-229-9117
8000 Regency Parkway, Suite 280 Cary, NC 27518
PHONE: +1-919-460-0695 FAX: +1-919-460-0795

85 W. Algonquin Road, Suite 280
Arlington Heights, IL 60005
PHONE: +1-847-258-2750 FAX: +1-847-439-2479

3001 West Big Beaver Road, Suite 722
Troy, MI 48084
PHONE: +1-248-458-1527 FAX: +1-248-458-6255

EUROPE

**SHARP MICROELECTRONICS EUROPE
A division of Sharp Electronics (Europe) GmbH**

■ European Head Office
Sonninstrasse 3, 20097, Hamburg, Germany
PHONE: +49-18-0507-3507
(Calls cost € 0.14 per minute from German landlines and no more than € 0.42 from the German mobile network.)
http://www.sharpsme.com

■ Germany:

Munich Office
Landsberger Strasse 398, 81241 Munich, Germany
PHONE: +49-89-5468-420 FAX: +49-89-5468-4250

■ Italy:

Milan Office
Centro Direzionale Colleoni Palazzo Taurus Ingresso 2
20041 Agrate Brianza, Milano, Italy
PHONE: +39-039-689-99 46 FAX: +39-039-689-99 48

■ UK:

PO Box 8173
Reading, RG6 9PD, UK

■ Sweden:

Nordic Office
Kanalvägen 1A, 19427 Upplands Väsby, Sweden
PHONE: +46-8751-1493 FAX: +46-8751-1498

ASIA

**SHARP ELECTRONICS (SHANGHAI) CO., LTD.
Microelectronics Sales & Marketing Division**

15F, King Tower, 28 Xin Jin Qiao Road,
Pudong DIST, Shanghai 201206 P.R. China
PHONE: +86-21-5854-7710/21-5834-6056
FAX: +86-21-5030-4510/21-5834-6057
http://ses.sharpmicro.com

■ Registered Address

No. 588, Aoni Rd., Xin Development Bldg 65,
WaiGaoQiao Free Trade Zone, Shanghai 200131,
P.R. China

■ Beijing Office

5F, Tower F, Phoenix Place, 5A, Shuguang xili,
Chaoyang District, Beijing 100028, P.R. China
PHONE: +86-10-85215688 FAX: +86-10-65880773

SHARP-ROXY (HONG KONG) LTD.

Device Business Division, Level 26, Tower 1, Kowloon
Commerce Centre, NO.51 Kwai Cheong Road, Kwai
Chung, N.T., Hong Kong
PHONE: +852-28229311 FAX: +852-28660779
http://www.sharp.com.hk

■ Shenzhen Representative Office

Room 602-603, 6/F, International Chamber of
Commerce Tower, 168 Fuhua Rd. 3, CBD, Futian
District, Shenzhen 518048, Guangdong, P.R. China
PHONE: +86-755-88313505 FAX: +86-755-88313515

**SHARP ELECTRONIC COMPONENTS (TAIWAN)
CORPORATION**

8F-A, No. 16, Sec. 4, Nanking E. Rd., Taipei, Taiwan
PHONE: +886-2-2577-7341
FAX: +886-2-2577-7326/2-2577-7328

SHARP ELECTRONICS (SINGAPORE) PTE., LTD.

491B River Valley Road, #09-02/03/04
Valley Point, Singapore 248373
PHONE: +65-63042500 FAX: +65-63042598
http://www.sesl-sharp.com

**SHARP ELECTRONIC COMPONENTS (KOREA)
CORPORATION**

5F, Jeil Pharm B/D, 745-5, Banpo 1-dong,
Seocho-ku, Seoul 137-810 Korea
PHONE: +82-2-711-5813 FAX: +82-2-711-5819



The following facilities of Sharp Corporation have been certified under the ISO 14001 international standard for environmental management systems. In our products and manufacturing processes, we are actively engaged in environmental preservation efforts.

Facility	Certificate No.	Date of Registration	Scope of Registered Activities
Headquarters and Associated Companies Group	EC97J1037	June 24, 1997	Research and development of electronic and electric products and general electronic components, sales and service activities, and general administration within the registered organization
Katsuragi Works	EC99J2006	June 25, 1996	Development, design and production of photovoltaic cells and electronic devices
Electronic Components and Devices Group (Fukuyama)	EC99J2016	September 24, 1996	The manufacture of IC (Memory, Logic, etc.)
Advanced Development and Planning Center	EC99J2038	December 3, 1996	Research and development, production engineering development and promotion, design and manufacture of electronic devices
Mie Plant	EC99J2051	January 28, 1997	The manufacture of compact LCD panels
Kameyama Plant	EC04J0284	October 12, 2004	Development, design and manufacture of LCDs
Electronic Components and Devices Group (Mihara)	20002660 UM	November 17, 2003	Production and development of Large LCD TVs
			Design, development and manufacture of laser diodes, hologram laser and LED devices and printed wiring board, design of optical pick-up units



The following groups of Sharp Corporation have been certified under the ISO 9001:2008 international standard for quality management systems.

Certifying organization: Japan Quality Assurance Organization (JQA) [JAB certified]

Group	Certificate No.	Scope of Registered Activities
Electronic Components and Devices Group*1	JQA-QM8688	The design / development and manufacture of integrated circuits The design / development and manufacture of RF devices The design / development and manufacture of Opto-electronic devices The design / development and manufacture of module The design / development and manufacture of printed circuit board The design / development and manufacture of LEDs The design / development and manufacture of laser diodes, hologram laser The design / development and manufacture of optical pick-ups
Liquid Crystal Display Group	JQA-QMA11778	1) Design, development and manufacture of LCD panels 2) Design and development of LCD modules
General Manager, Display Device Business*2	JQA-QM3776	Design, development, and manufacture of LCD panels and modules

*1 This Group designates Sharp Takaya Electronics Industry Co., Ltd. (JQA-AU0212) as an ISO/TS16949: 2009 management system registered facility with regard to design, development and manufacture of camera units for vehicle use, with registration as a management system support division.

*2 The Group name has been changed from Liquid Crystal Display Group as of April 1, 2011.

(The above information is current as of June 2011.)



This brochure uses vegetable oil ink.

Distributed by

The contents of this catalog are current as of December 2011.