



MAX16825 Evaluation Kit

Evaluates: MAX16825

General Description

The MAX16825 evaluation kit (EV kit) demonstrates a high-voltage, 3-channel, linear high-brightness LED (HB LED) driver using the MAX16825 IC. This EV kit is configured to supply an LED current of 100mA per channel and operates from a 0.5A, 6.5V to 28V rated power supply.

The MAX16825 EV kit uses a standard 4-wire SPI™ interface for independently controlling each of the three LED channels. The MAX16825 EV kit also integrates a USB-to-SPI interface circuit based on Maxim's MAXQ2000 microcontroller. The EV kit includes Windows 2000/XP/Vista®-compatible software that provides a simple graphical user interface (GUI) for exercising the features of the MAX16825. The EV kit can also interface with a user-supplied SPI circuit for stand-alone operation.

Features

- ◆ Operates from a 6.5V to 28V, 0.5A Supply
- ◆ 3 Channels for Driving High-Brightness LEDs
- ◆ 100mA LED Current per Channel
- ◆ Evaluates a Stand-Alone 4-Wire SPI Interface
- ◆ USB-PC Interface (Cable Included)
- ◆ Windows 2000/XP/Vista (32-Bit)-Compatible Software
- ◆ Fully Assembled and Tested

Ordering Information

PART	TYPE
MAX16825EVKIT+	EV Kit

+Denotes lead-free and RoHS-compliant.

Component List

DESIGNATION	QTY	DESCRIPTION
C1, C3–C10, C17	10	0.1μF ±10%, 16V X7R ceramic capacitors (0603) TDK C1608X7R1C104K
C2, C13, C15	3	10μF ±20%, 6.3V X5R ceramic capacitors (0805) TDK C2012X5R0J106M
C11, C12	2	10pF ±5%, 50V C0G ceramic capacitors (0603) TDK C1608C0G1H100J
C14, C16, C22	3	1μF ±10%, 10V X5R ceramic capacitors (0603) Murata GRM188R61A105K
C18, C19	2	22pF ±5%, 50V C0G ceramic capacitors (0603) TDK C1608C0G1H220J
C20	1	3300pF ±10%, 50V X7R ceramic capacitor (0603) TDK C1608X7R1H332K
C21	1	1μF ±10%, 50V X7R ceramic capacitor (1210) Murata GRM32ER71H105K or TDK C3325X7R1H105K

DESIGNATION	QTY	DESCRIPTION
D1	1	Green LED (0603) Panasonic LNJ314G8TRA
FB1	0	Not installed, ferrite-bead inductor (0603)
H1, J1	0	Not installed, dual-row (2 x 5) 10-pin headers
J2	0	Not installed, dual-row (2 x 4) 8-pin header
P1	1	USB type-B right-angle female receptacle
R1	1	0Ω ±5% resistor (0603)
R2	1	220Ω ±5% resistor (0603)
R3	1	10kΩ ±5% resistor (0603)
R4	1	2.2kΩ ±5% resistor (0603)
R5	1	1.5kΩ ±5% resistor (0603)
R6, R7	2	27Ω ±5% resistors (0603)
R8, R9, R10	3	2Ω ±1%, 0.25W sense resistors (1206) IRC WCR-WCR1206LF-2R00-F
R11	0	Not installed, resistor (0402)

SPI is a trademark of Motorola, Inc.

Windows Vista is a registered trademark of Microsoft Corp.



Maxim Integrated Products 1

For pricing, delivery, and ordering information, please contact Maxim Direct at 1-888-629-4642, or visit Maxim's website at www.maxim-ic.com.

MAX16825 Evaluation Kit

Component List (continued)

DESIGNATION	QTY	DESCRIPTION
U1	1	SPI-controlled linear HB LED driver (16-pin TSSOP-EP*) Maxim MAX16825AUE+
U2	1	Low-power 16-bit microcontroller (68-pin QFN-EP*, 10mm x 10mm) Maxim MAXQ2000-RAX+
U3	1	93C46 type 3-wire EEPROM (8-pin SO)
U4	1	UART-to-USB converter (32-pin TQFP, 7mm x 7mm)
U5	1	3.3V regulator (5-pin SC70) Maxim MAX8511EXK33+T (Top Mark: AEI)
U6	1	2.5V regulator (5-pin SC70) Maxim MAX8511EXK25+T (Top Mark: ADV)
Y1	1	16MHz crystal
Y2	1	6MHz crystal
—	1	USB high-speed A-to-B cable, 6ft
—	1	PCB: MAX16825 Evaluation Kit+

*EP = Exposed paddle.

Quick Start

Required Equipment

Before beginning, the following equipment is needed:

- MAX16825 EV kit (USB cable included)
- 6.5V to 28V, 0.5A adjustable DC power supply
- User-supplied Windows 2000/XP/Vista PC with a spare USB port
- Three LED loads, each rated as follows:
Current rating $\geq 100\text{mA}$
Total LED string forward voltage $V_{\text{FLED}} \leq 26.3\text{V}$
- See the *LED Load Configuration* section for more information

Note: In the following sections, software-related items are identified by bolding. Text in **bold** refers to items directly from the EV kit software. Text in **bold and underlined** refers to items from the Windows operating system.

Procedure

The MAX16825 EV kit is fully assembled and tested. Follow the steps below to verify board operation.

Caution: Do not turn on the power supply until all connections are completed.

Component Suppliers

SUPPLIER	PHONE	WEBSITE
IRC, Inc.	361-992-7900	www.irctt.com
Murata Mfg. Co., Ltd	770-436-1300	www.murata.com
Panasonic	800-344-2112	www.panasonic.com
TDK Corp.	847-803-6100	www.component.tdk.com

Note: Indicate that you are using the MAX16825 when contacting these component suppliers.

MAX16825 EV Kit Files

FILE	DESCRIPTION
INSTALL.EXE	Installs the EV kit files on your computer
MAX16825.EXE	Application program
FTD2XX.INF	USB device driver file
UNINST.INI	Uninstalls the EV kit software
TROUBLESHOOTING_USB.PDF	USB driver installation help file

- 1) Visit www.maxim-ic.com/evkitsoftware to download the latest version of the EV kit software, 16825Rxx.ZIP. Save the EV kit software to a temporary folder and uncompress the ZIP file.
- 2) Install the EV kit software on your computer by running the INSTALL.EXE program inside the temporary folder. The program files are copied and icons are created in the Windows **Start | Programs** menu. All EV kit files are automatically installed.
- 3) Set the power-supply output to over $V_{\text{FLED}} + 1.7\text{V}$.
- 4) Disable the power-supply output.
- 5) Connect the power-supply ground to the GND pad next to the VIN pad.
- 6) Connect the power-supply positive output to the VIN pad.
- 7) Connect one LED load anode to each LED output pad (LED1+, LED2+, or LED3+).
- 8) Connect each LED load cathode to the corresponding LED input pad (LED1-, LED2-, or LED3-).
- 9) Connect the USB cable from the PC to the EV kit board. A **New Hardware Found** window pops up when installing the USB driver for the first time. If you do not see a window that is similar to the one

MAX16825 Evaluation Kit

described above after 30s, remove the USB cable from the board and reconnect it. Administrator privileges are required to install the USB device driver on Windows.

- 10) Follow the directions of the **Add New Hardware Wizard** to install the USB device driver. Choose the **Search for the best driver for your device** option. Specify the location of the device driver to be **C:\Program Files\MAX16825** (default installation directory) using the **Browse** button. During device driver installation, Windows may show a warning message indicating that the device driver Maxim uses does not contain a digital signature. This is not an error condition and it is safe to proceed with installation. Refer to the TROUBLESHOOTING_USB.PDF document included with the software for additional information.
- 11) Enable the power-supply output.
- 12) Start the EV kit software by opening its icon in the **Start | Programs** menu. The MAX16825 EV kit software main window appears, as shown in Figure 1.
- 13) Select the **Output Enable** checkbox and any of the **Channel_** checkboxes.
- 14) Verify that the corresponding attached LEDs are illuminated.

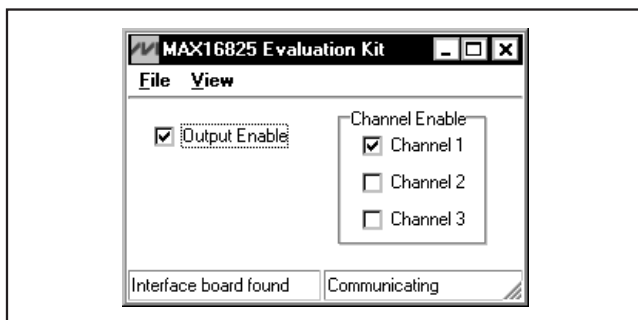

Figure 1. MAX16825 Evaluation Kit Software—Graphical User Interface (GUI)

Detailed Description of Software

Graphical User Interface

The main window's GUI (Figure 1) is simple to use. A mouse or the keyboard's tab key is used to navigate through the controls. The correct SPI write operation is generated to update the internal registers of the MAX16825 when any of these controls are used.

The software features a demo mode that is available by selecting the **View | Demo Mode** menu item. When operating in demo mode, all software communication to the EV kit hardware is disabled and most of the software's GUI is functional. This feature enables the user to evaluate the software without hardware connectivity.

The left-bottom status bar provides the USB-to-SPI communication status. The right-bottom status bar provides the current program status. The MAX16825 EV kit software configures the on-board SPI communication to 8kHz by default.

Software Startup

Upon starting the program, select the **Output Enable** checkbox to enable the LED outputs. Deselecting the **Output Enable** checkbox disables all three LED outputs. The **Channel_** checkboxes enable and disable individual channels.

General-Purpose 3-Wire (SPI) Interface Utility

The general-purpose **3-wire interface** utility (Figure 2) can also be used to communicate with the MAX16825 using low-level SPI commands. Select the **Options | Interface** menu item and select the **3-wire interface** tab to access the utility. The utility configures the 3-wire serial-interface parameters, such as MSB position, CPOL, CPHA, MOSI/MISO inverted logic, CS active state (high or low), SPI clock (SCLK) speed, and custom selection of SPI signal pins. The data to be sent is 8-bit data represented by a two-digit hexadecimal code. The code is entered in the **Data bytes to be written** edit box and transmitted by clicking on the **Send Now** button.

General Troubleshooting

Problem: Software reports it cannot find the interface circuit.

- Is power LED D1 lit?
- Is the USB cable connected to the PC and EV kit?
- Is power applied to the VIN PCB pad?
- Has Windows plug-and-play detected the board? Bring up the **Control Panel > System > Device Manager**, and look at what device nodes are indicated for USB. If there is an unknown device node attached to the USB, delete it. This process forces plug-and-play to try again.

MAX16825 Evaluation Kit

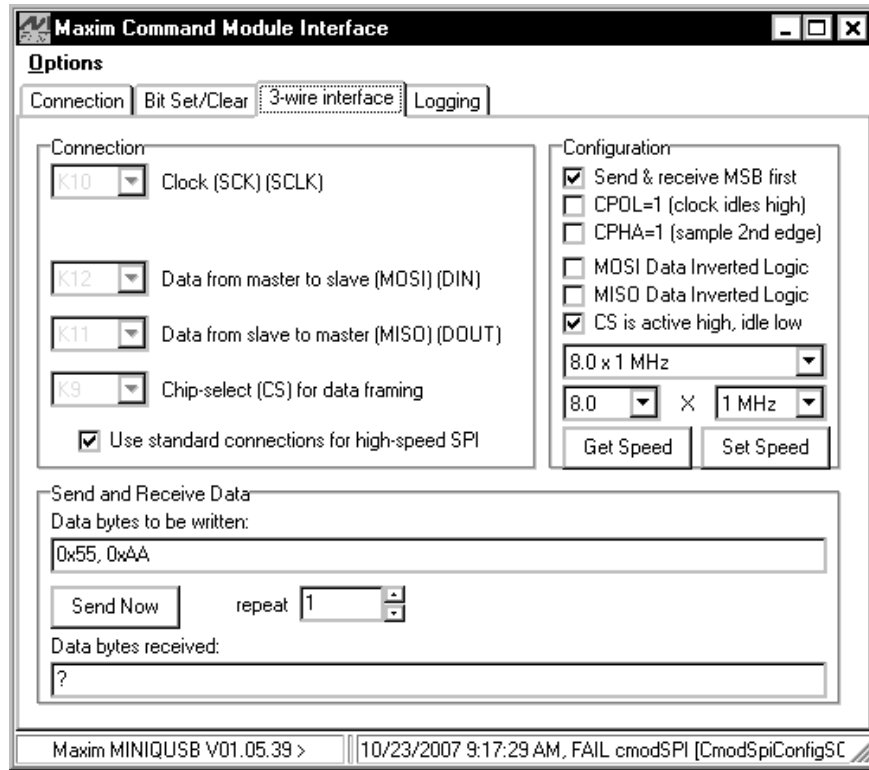

Figure 2. The 3-Wire Interface Window Provides Direct, Low-Level Access to the MAX16825 and 3-Wire Serial Interface

MAX16825 Evaluation Kit

Evaluates: MAX16825

Detailed Description of Hardware

The MAX16825 EV kit demonstrates a high-voltage, 3-channel, linear high-brightness LED driver using the MAX16825 IC in a 16-pin TSSOP surface-mount package. This EV kit is configured to supply an LED current of 100mA per channel. The MAX16825 IC controls the LED current by maintaining a 200mV drop across each external sense resistor (R8, R9, and R10). The EV kit operates from a 0.5A, 6.5V to 28V rated power supply.

The MAX16825 EV kit uses a standard 4-wire SPI interface for independently controlling each of the three individual channels. Only the components in the Figure 3 schematic are required when using a user-supplied SPI interface. The MAX16825 integrates a USB-to-SPI interface circuit that is based on Maxim's MAXQ2000 16-bit microcontroller. The EV kit includes Windows 2000/XP/Vista-compatible software that provides a GUI for exercising the MAX16825 features. The components on the Figure 4 schematic are only required for PC evaluation and are not needed for an HB LED design.

The MAX16825 features an exposed paddle that uses the top-layer and bottom-layer PCB copper as a heatsink. The exposed paddle connects to GND.

LED Load Configuration

The MAX16825 EV kit can drive three separate LED loads. Each LED load can consist of multiple LEDs connected in series. The LED load's forward voltage can be up to 26.3V. The EV kit drives LEDs rated for at least 100mA. Proper heat sinking of the LEDs is important for optimum LED performance and durability.

Output Current Setting

The current for each MAX16825 EV kit LED channel (I_{LED1}, I_{LED2}, and I_{LED3}) is configured to 100mA by three sense resistors (R8, R9, and R10, respectively). See the equation below to select a different LED current and a new resistor value. If designing for a higher LED current, verify that the desired current setting does not exceed the power rating of the corresponding resistor (R8, R9, R10) or the LED load. **Do not set the LED current above 150mA.** Use the following equation to calculate the value of the new resistor:

$$R_{-} = \frac{200\text{mV}}{I_{\text{LED}_{-}}}$$

where I_{LED₋} is the desired LED current and R₋ is the resistor value required to set the desired current of the LED channel.

MAX16825 Evaluation Kit

High Input Voltage and Thermal Protection

The MAX16825 IC operates in linear mode. As a result, the IC can dissipate significant power if operated using a high input voltage and a small V_{FLED} . High-power dissipation may cause the IC to go into thermal shutdown. Refer to the *Thermal Protection* section in the MAX16824/MAX16825 IC data sheet for more information.

User-Supplied SPI Interface

The user may control the MAX16825 EV kit directly with a user-supplied, 5V logic, 4-wire SPI interface for stand-alone operation. Cut open header J2's shorting traces located on the PCB's bottom layer. Connect the user-supplied \overline{CS} , SCLK, DIN, and a control signal to the \overline{OE} , CLK, DIN, and LE pads, respectively, on the MAX16825 EV kit. Refer to the *Electrical Characteristics, SPI Interface* section of the MAX16825 IC data sheet for more information on the MAX16825's SPI communication requirements.

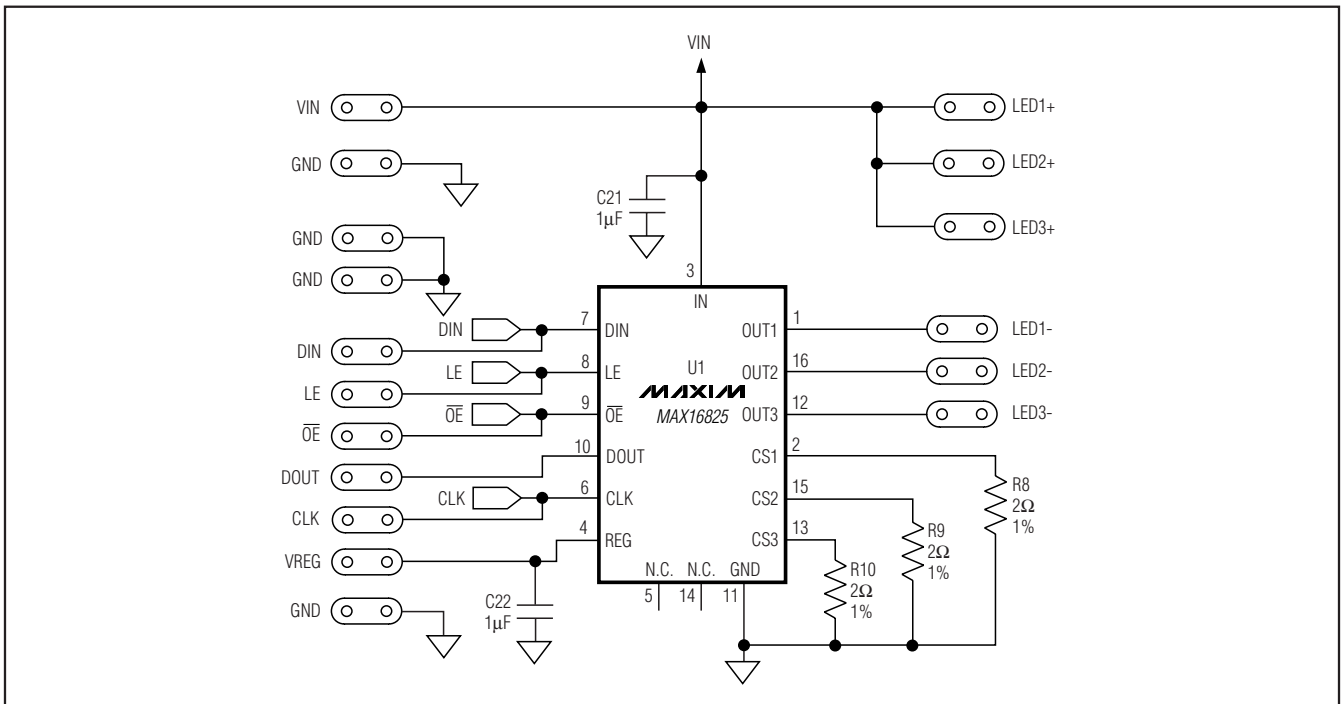

Figure 3. MAX16825 EV Kit Schematic—LED Driver Circuit

MAX16825 Evaluation Kit

Evaluates: MAX16825

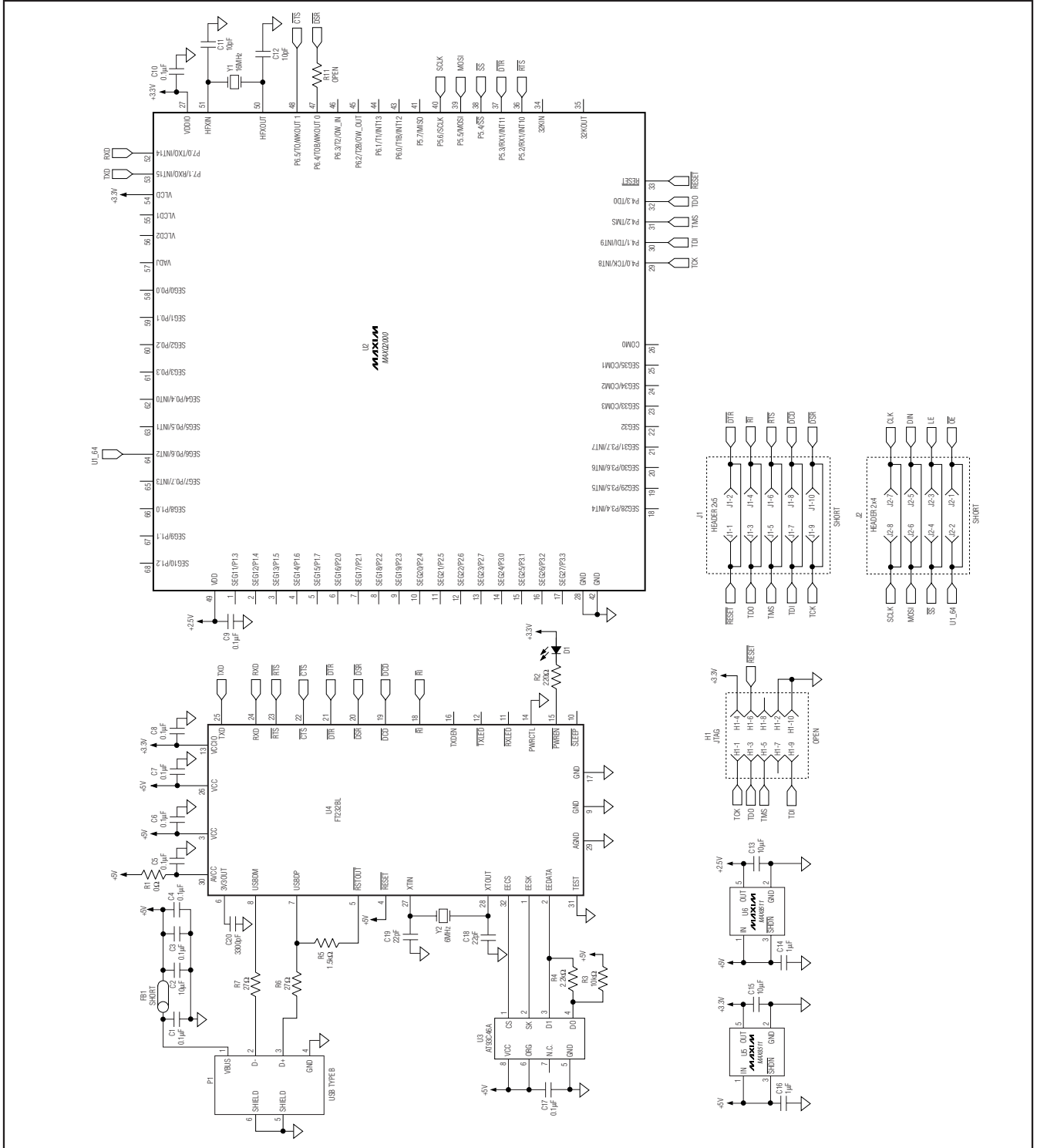

Figure 4. MAX16825 EV Kit Schematic—USB and SPI Interface Circuit

MAX16825 Evaluation Kit

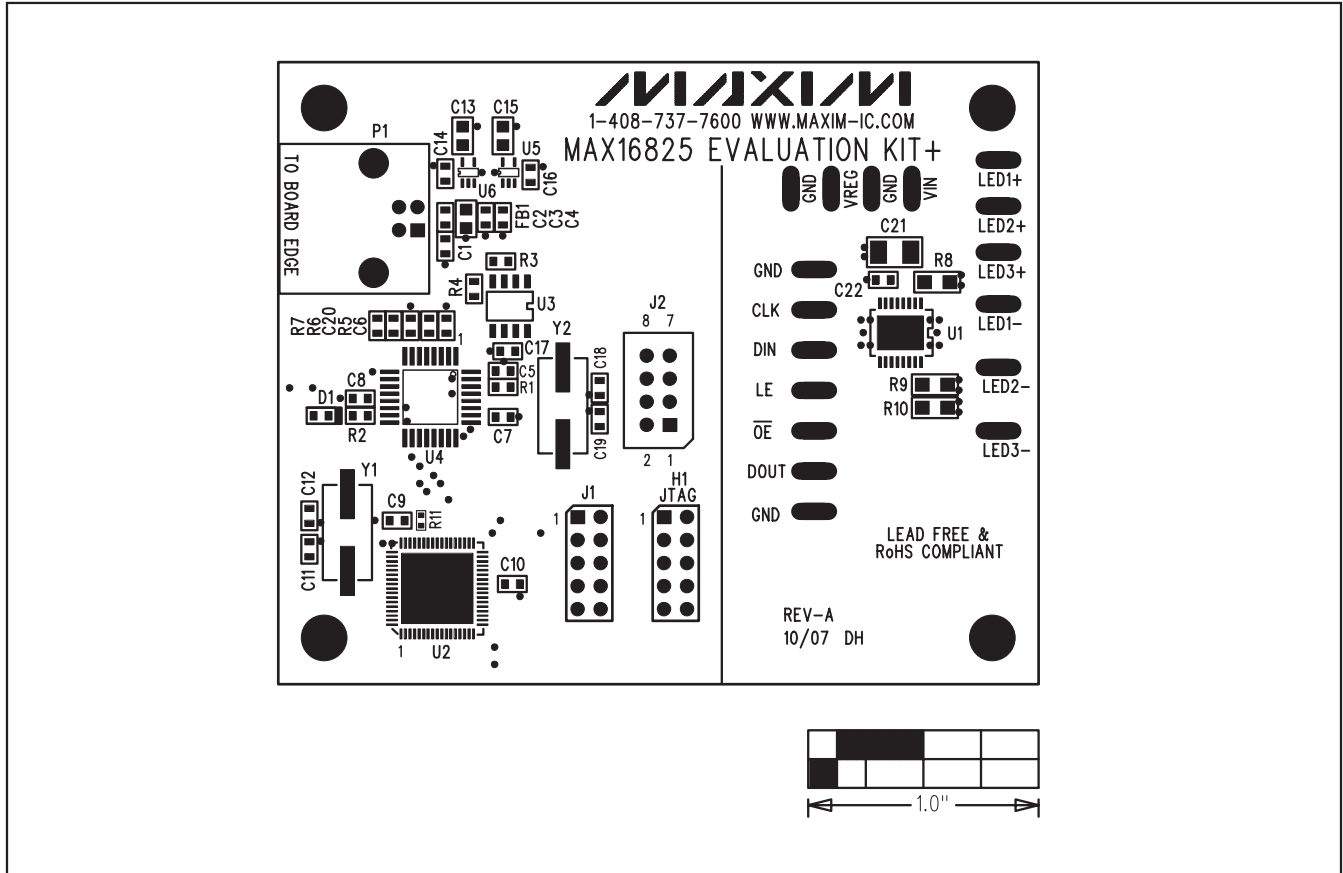

Figure 5. MAX16825 EV Kit Component Placement Guide—Component Side

MAX16825 Evaluation Kit

Evaluates: MAX16825

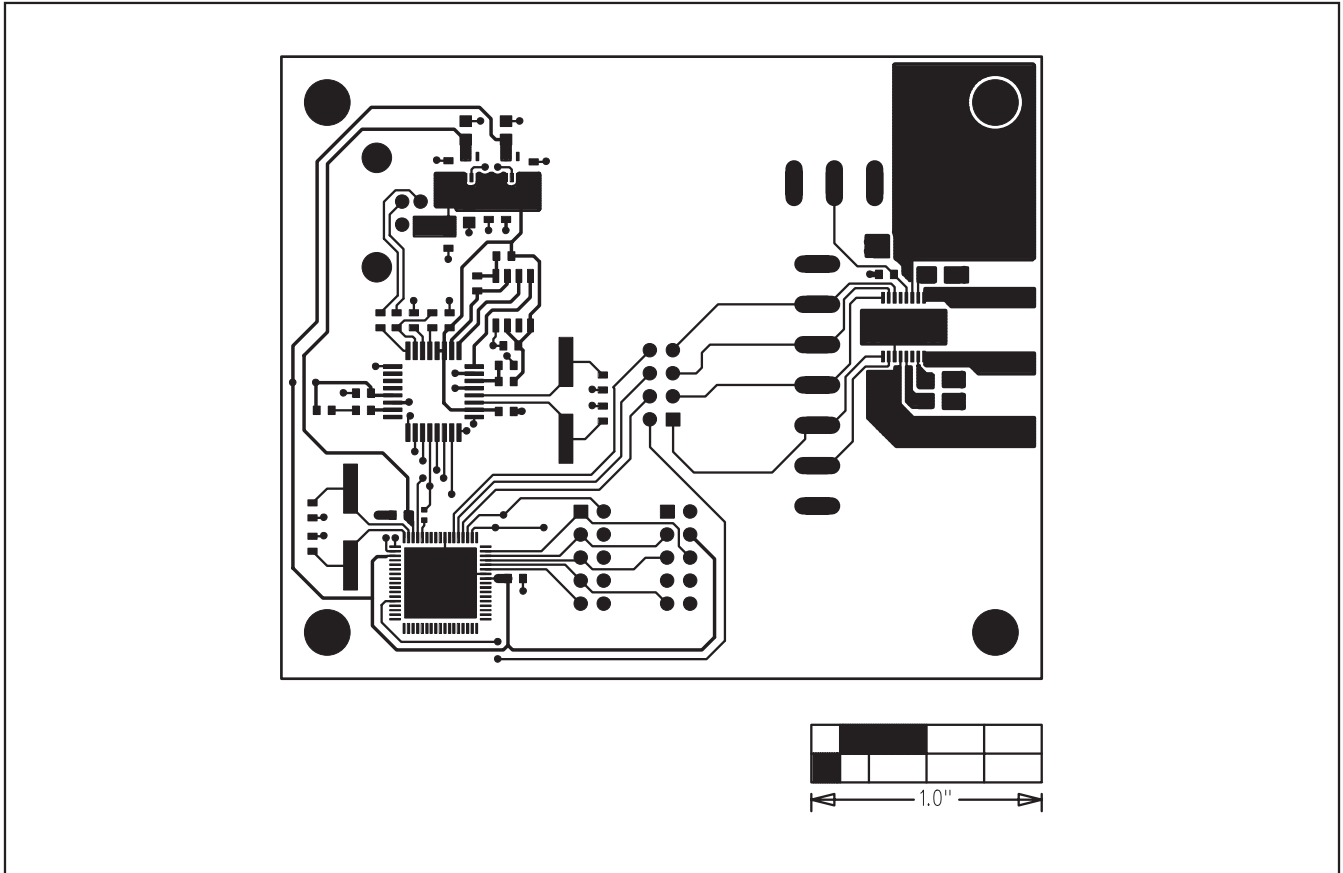

Figure 6. MAX16825 EV Kit PCB Layout—Component Side

MAX16825 Evaluation Kit

Evaluates: MAX16825

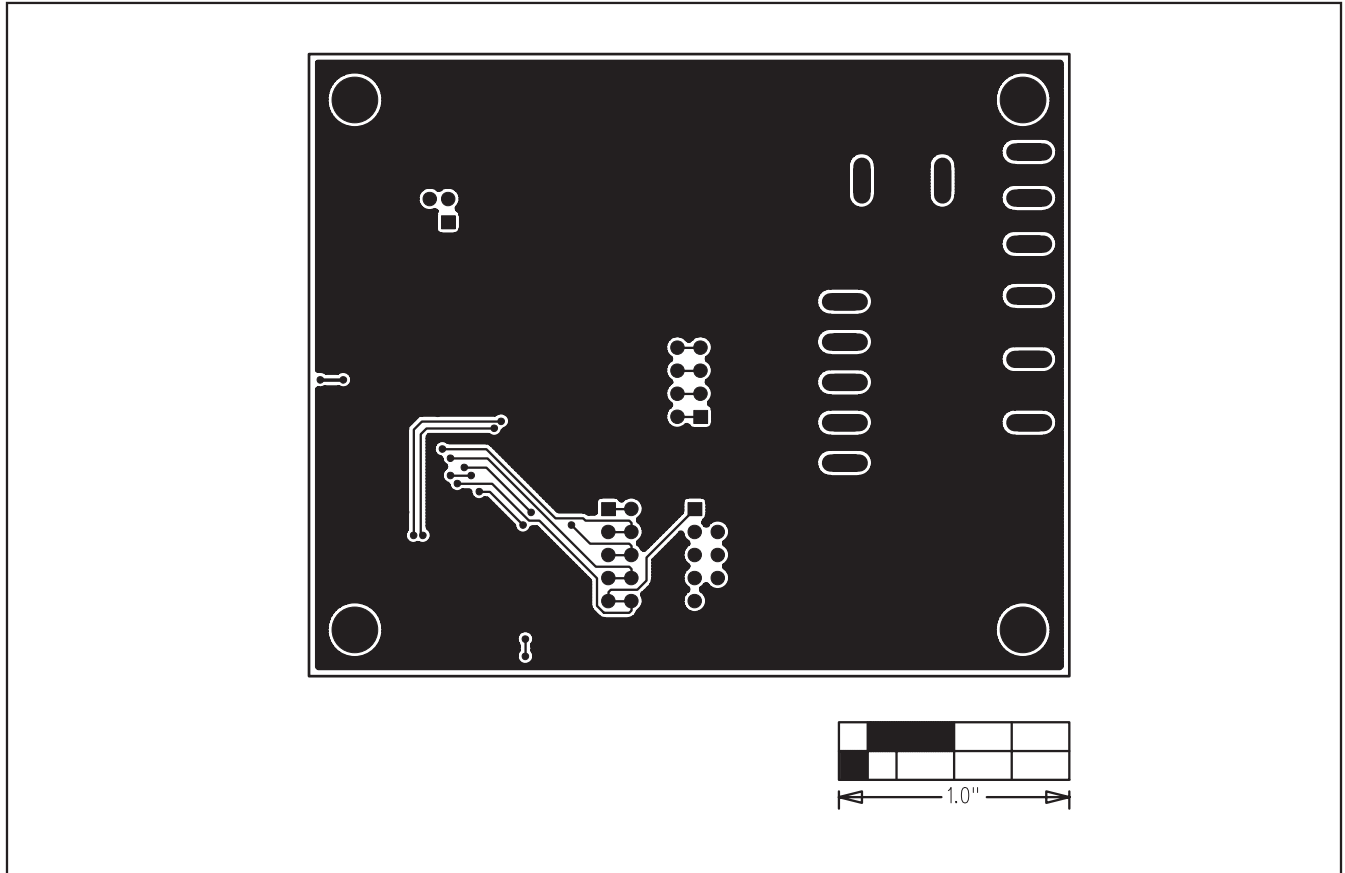

Figure 7. MAX16825 EV Kit PCB Layout—Solder Side

Maxim cannot assume responsibility for use of any circuitry other than circuitry entirely embodied in a Maxim product. No circuit patent licenses are implied. Maxim reserves the right to change the circuitry and specifications without notice at any time.

10 _____ **Maxim Integrated Products, 120 San Gabriel Drive, Sunnyvale, CA 94086 408-737-7600**

© 2008 Maxim Integrated Products

MAXIM is a registered trademark of Maxim Integrated Products, Inc.