

# 74AUP1G34

Low-power buffer

Rev. 8 — 8 June 2018

Product data sheet

## 1 General description

---

The 74AUP1G34 provides a low-power, low-voltage single buffer.

Schmitt trigger action at all inputs makes the circuit tolerant to slower input rise and fall times across the entire  $V_{CC}$  range from 0.8 V to 3.6 V.

This device ensures a very low static and dynamic power consumption across the entire  $V_{CC}$  range from 0.8 V to 3.6 V.

This device is fully specified for partial power-down applications using  $I_{OFF}$ . The  $I_{OFF}$  circuitry disables the output, preventing the damaging backflow current through the device when it is powered down.

## 2 Features and benefits

---

- Wide supply voltage range from 0.8 V to 3.6 V
- High noise immunity
- Complies with JEDEC standards:
  - JESD8-12 (0.8 V to 1.3 V)
  - JESD8-11 (0.9 V to 1.65 V)
  - JESD8-7 (1.2 V to 1.95 V)
  - JESD8-5 (1.8 V to 2.7 V)
  - JESD8-B (2.7 V to 3.6 V)
- ESD protection:
  - HBM: ANSI/ESDA/JEDEC JS-001 Class 3A exceeds 5000 V
  - CDM: ANSI/ESDA/JEDEC JS-002 Class C3 exceeds 1000 V
  - MM: JESD22-A115-A exceeds 200 V
- Low static power consumption;  $I_{CC} = 0.9 \mu\text{A}$  (maximum)
- Latch-up performance exceeds 100 mA per JESD 78 Class II
- Inputs accept voltages up to 3.6 V
- Low noise overshoot and undershoot < 10 % of  $V_{CC}$
- $I_{OFF}$  circuitry provides partial power-down mode operation
- Multiple package options
- Specified from -40 °C to +85 °C and -40 °C to +125 °C

### 3 Ordering information

Table 1. Ordering information

Type number	Package			Version
	Temperature range	Name	Description	
74AUP1G34GW	-40 °C to +125 °C	TSSOP5	plastic thin shrink small outline package; 5 leads; body width 1.25 mm	SOT353-1
74AUP1G34GM	-40 °C to +125 °C	XSON6	plastic extremely thin small outline package; no leads; 6 terminals; body 1 x 1.45 x 0.5 mm	SOT886
74AUP1G34GF	-40 °C to +125 °C	XSON6	plastic extremely thin small outline package; no leads; 6 terminals; body 1 x 1 x 0.5 mm	SOT891
74AUP1G34GN	-40 °C to +125 °C	XSON6	extremely thin small outline package; no leads; 6 terminals; body 0.9 x 1.0 x 0.35 mm	SOT1115
74AUP1G34GS	-40 °C to +125 °C	XSON6	extremely thin small outline package; no leads; 6 terminals; body 1.0 x 1.0 x 0.35 mm	SOT1202
74AUP1G34GX	-40 °C to +125 °C	X2SON5	plastic thermal enhanced extremely thin small outline package; no leads; 5 terminals; body 0.8 x 0.8 x 0.35 mm	SOT1226
74AUP1G34GX4	-40 °C to +125 °C	X2SON4	plastic thermal enhanced extremely thin small outline package; no leads; 4 terminals; body 0.6 x 0.6 x 0.32 mm	SOT1269-2
74AUP1G34UK	-40 °C to +125 °C	WLCSP6	wafer level chip-scale package; 6 bumps; 0.65 x 0.44 x 0.27 mm	SOT1454-1

### 4 Marking

Table 2. Marking

Type number	Marking code <sup>[1]</sup>
74AUP1G34GW	aN
74AUP1G34GM	aN
74AUP1G34GF	aN
74AUP1G34GN	aN
74AUP1G34GS	aN
74AUP1G34GX	aN
74AUP1G34GX4	aN
74AUP1G34UK	4

[1] The pin 1 indicator is located on the lower left corner of the device, below the marking code.

5 Functional diagram

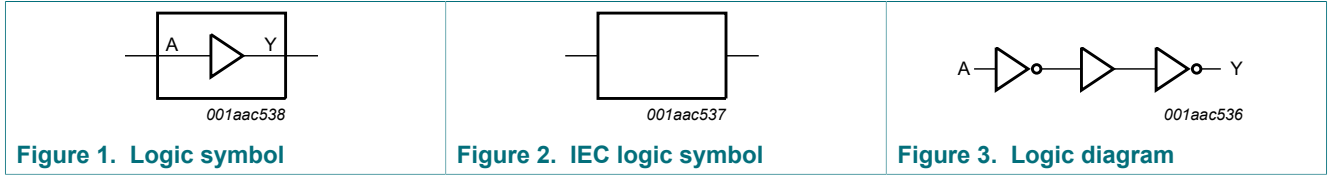

6 Pinning information

6.1 Pinning

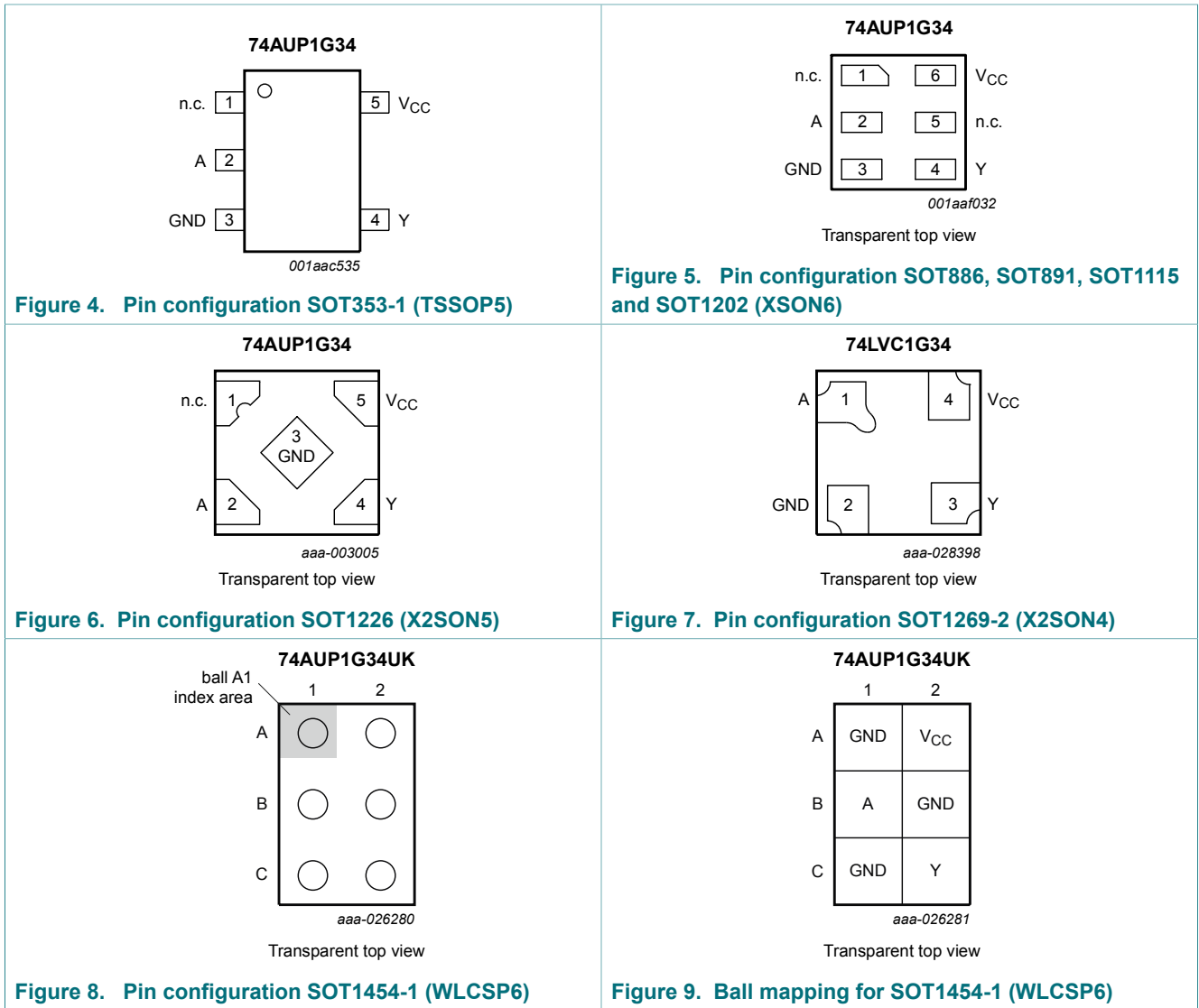

## 6.2 Pin description

Table 3. Pin description

Symbol	Pin				Description
	TSSOP5 and X2SON5	XSON6	X2SON4	WLCSP6	
n.c.	1	1	-	-	not connected
A	2	2	1	B1	data input
GND	3	3	2	A1, B2, C1	ground (0 V)
Y	4	4	3	C2	data output
n.c.	-	5	-	-	not connected
V <sub>CC</sub>	5	6	4	A2	supply voltage

## 7 Functional description

Table 4. Function table

*H = HIGH voltage level; L = LOW voltage level.*

Input	Output
<b>A</b>	<b>Y</b>
L	L
H	H

## 8 Limiting values

**Table 5. Limiting values**

In accordance with the Absolute Maximum Rating System (IEC 60134). Voltages are referenced to GND (ground = 0 V).

Symbol	Parameter	Conditions	Min	Max	Unit
$V_{CC}$	supply voltage		-0.5	+4.6	V
$I_{IK}$	input clamping current	$V_I < 0$ V	-50	-	mA
$V_I$	input voltage		-0.5	+4.6	V
$I_{OK}$	output clamping current	$V_O < 0$ V	-50	-	mA
$V_O$	output voltage	Active mode and Power-down mode	-0.5	+4.6	V
$I_O$	output current	$V_O = 0$ V to $V_{CC}$	-	$\pm 20$	mA
$I_{CC}$	supply current		-	+50	mA
$I_{GND}$	ground current		-50	-	mA
$T_{stg}$	storage temperature		-65	+150	°C
$P_{tot}$	total power dissipation	$T_{amb} = -40$ °C to +125 °C			
		TSSOP5, XSON6, X2SON5 and WLCSP6 package	-	250	mW
		X2SON4 package	-	150	mW

[1] The input and output voltage ratings may be exceeded if the input and output current ratings are observed.

[2] For TSSOP5 packages: above 87.5 °C the value of  $P_{tot}$  derates linearly with 4.0 mW/K.

For XSON6 and X2SON5 packages: above 118 °C the value of  $P_{tot}$  derates linearly with 7.8 mW/K.

For WLCSP6 package: above 102.5 °C the value of  $P_{tot}$  derates linearly with 5.3 mW/K.

[3] For X2SON4 packages: above 57 °C the value of  $P_{tot}$  derates linearly with 1.7 mW/K.

## 9 Recommended operating conditions

**Table 6. Recommended operating conditions**

Symbol	Parameter	Conditions	Min	Max	Unit
$V_{CC}$	supply voltage		0.8	3.6	V
$V_I$	input voltage		0	3.6	V
$V_O$	output voltage	Active mode	0	$V_{CC}$	V
		Power-down mode; $V_{CC} = 0$ V	0	3.6	V
$T_{amb}$	ambient temperature		-40	+125	°C
$\Delta t/\Delta V$	input transition rise and fall rate	$V_{CC} = 0.8$ V to 3.6 V	0	200	ns/V

## 10 Static characteristics

**Table 7. Static characteristics**

At recommended operating conditions; voltages are referenced to GND (ground = 0 V).

Symbol	Parameter	Conditions	Min	Typ	Max	Unit
<b>T<sub>amb</sub> = 25 °C</b>						
V <sub>IH</sub>	HIGH-level input voltage	V <sub>CC</sub> = 0.8 V	0.70 × V <sub>CC</sub>	-	-	V
		V <sub>CC</sub> = 0.9 V to 1.95 V	0.65 × V <sub>CC</sub>	-	-	V
		V <sub>CC</sub> = 2.3 V to 2.7 V	1.6	-	-	V
		V <sub>CC</sub> = 3.0 V to 3.6 V	2.0	-	-	V
V <sub>IL</sub>	LOW-level input voltage	V <sub>CC</sub> = 0.8 V	-	-	0.30 × V <sub>CC</sub>	V
		V <sub>CC</sub> = 0.9 V to 1.95 V	-	-	0.35 × V <sub>CC</sub>	V
		V <sub>CC</sub> = 2.3 V to 2.7 V	-	-	0.7	V
		V <sub>CC</sub> = 3.0 V to 3.6 V	-	-	0.9	V
V <sub>OH</sub>	HIGH-level output voltage	V <sub>I</sub> = V <sub>IH</sub> or V <sub>IL</sub>				
		I <sub>O</sub> = -20 μA; V <sub>CC</sub> = 0.8 V to 3.6 V	V <sub>CC</sub> - 0.1	-	-	V
		I <sub>O</sub> = -1.1 mA; V <sub>CC</sub> = 1.1 V	0.75 × V <sub>CC</sub>	-	-	V
		I <sub>O</sub> = -1.7 mA; V <sub>CC</sub> = 1.4 V	1.11	-	-	V
		I <sub>O</sub> = -1.9 mA; V <sub>CC</sub> = 1.65 V	1.32	-	-	V
		I <sub>O</sub> = -2.3 mA; V <sub>CC</sub> = 2.3 V	2.05	-	-	V
		I <sub>O</sub> = -3.1 mA; V <sub>CC</sub> = 2.3 V	1.9	-	-	V
		I <sub>O</sub> = -2.7 mA; V <sub>CC</sub> = 3.0 V	2.72	-	-	V
V <sub>OL</sub>	LOW-level output voltage	V <sub>I</sub> = V <sub>IH</sub> or V <sub>IL</sub>				
		I <sub>O</sub> = 20 μA; V <sub>CC</sub> = 0.8 V to 3.6 V	-	-	0.1	V
		I <sub>O</sub> = 1.1 mA; V <sub>CC</sub> = 1.1 V	-	-	0.3 × V <sub>CC</sub>	V
		I <sub>O</sub> = 1.7 mA; V <sub>CC</sub> = 1.4 V	-	-	0.31	V
		I <sub>O</sub> = 1.9 mA; V <sub>CC</sub> = 1.65 V	-	-	0.31	V
		I <sub>O</sub> = 2.3 mA; V <sub>CC</sub> = 2.3 V	-	-	0.31	V
		I <sub>O</sub> = 3.1 mA; V <sub>CC</sub> = 2.3 V	-	-	0.44	V
		I <sub>O</sub> = 2.7 mA; V <sub>CC</sub> = 3.0 V	-	-	0.31	V
I <sub>I</sub>	input leakage current	V <sub>I</sub> = GND to 3.6 V; V <sub>CC</sub> = 0 V to 3.6 V	-	-	±0.1	μA
		V <sub>I</sub> or V <sub>O</sub> = 0 V to 3.6 V; V <sub>CC</sub> = 0 V	-	-	±0.2	μA
I <sub>OFF</sub>	power-off leakage current	V <sub>I</sub> or V <sub>O</sub> = 0 V to 3.6 V; V <sub>CC</sub> = 0 V	-	-	±0.2	μA
ΔI <sub>OFF</sub>	additional power-off leakage current	V <sub>I</sub> or V <sub>O</sub> = 0 V to 3.6 V; V <sub>CC</sub> = 0 V to 0.2 V	-	-	±0.2	μA

Symbol	Parameter	Conditions	Min	Typ	Max	Unit
$I_{CC}$	supply current	$V_I = \text{GND or } V_{CC}; I_O = 0 \text{ A};$ $V_{CC} = 0.8 \text{ V to } 3.6 \text{ V}$	-	-	0.5	$\mu\text{A}$
$\Delta I_{CC}$	additional supply current	$V_I = V_{CC} - 0.6 \text{ V}; I_O = 0 \text{ A}; V_{CC} = 3.3 \text{ V}$ [1]	-	-	40	$\mu\text{A}$
$C_I$	input capacitance	$V_{CC} = 0 \text{ V to } 3.6 \text{ V}; V_I = \text{GND or } V_{CC}$	-	0.8	-	pF
$C_O$	output capacitance	$V_O = \text{GND}; V_{CC} = 0 \text{ V}$	-	1.7	-	pF
<b><math>T_{\text{amb}} = -40 \text{ }^\circ\text{C to } +85 \text{ }^\circ\text{C}</math></b>						
$V_{IH}$	HIGH-level input voltage	$V_{CC} = 0.8 \text{ V}$	$0.70 \times V_{CC}$	-	-	V
		$V_{CC} = 0.9 \text{ V to } 1.95 \text{ V}$	$0.65 \times V_{CC}$	-	-	V
		$V_{CC} = 2.3 \text{ V to } 2.7 \text{ V}$	1.6	-	-	V
		$V_{CC} = 3.0 \text{ V to } 3.6 \text{ V}$	2.0	-	-	V
$V_{IL}$	LOW-level input voltage	$V_{CC} = 0.8 \text{ V}$	-	-	$0.30 \times V_{CC}$	V
		$V_{CC} = 0.9 \text{ V to } 1.95 \text{ V}$	-	-	$0.35 \times V_{CC}$	V
		$V_{CC} = 2.3 \text{ V to } 2.7 \text{ V}$	-	-	0.7	V
		$V_{CC} = 3.0 \text{ V to } 3.6 \text{ V}$	-	-	0.9	V
$V_{OH}$	HIGH-level output voltage	$V_I = V_{IH} \text{ or } V_{IL}$				
		$I_O = -20 \mu\text{A}; V_{CC} = 0.8 \text{ V to } 3.6 \text{ V}$	$V_{CC} - 0.1$	-	-	V
		$I_O = -1.1 \text{ mA}; V_{CC} = 1.1 \text{ V}$	$0.7 \times V_{CC}$	-	-	V
		$I_O = -1.7 \text{ mA}; V_{CC} = 1.4 \text{ V}$	1.03	-	-	V
		$I_O = -1.9 \text{ mA}; V_{CC} = 1.65 \text{ V}$	1.30	-	-	V
		$I_O = -2.3 \text{ mA}; V_{CC} = 2.3 \text{ V}$	1.97	-	-	V
		$I_O = -3.1 \text{ mA}; V_{CC} = 2.3 \text{ V}$	1.85	-	-	V
		$I_O = -2.7 \text{ mA}; V_{CC} = 3.0 \text{ V}$	2.67	-	-	V
$V_{OL}$	LOW-level output voltage	$V_I = V_{IH} \text{ or } V_{IL}$				
		$I_O = 20 \mu\text{A}; V_{CC} = 0.8 \text{ V to } 3.6 \text{ V}$	-	-	0.1	V
		$I_O = 1.1 \text{ mA}; V_{CC} = 1.1 \text{ V}$	-	-	$0.3 \times V_{CC}$	V
		$I_O = 1.7 \text{ mA}; V_{CC} = 1.4 \text{ V}$	-	-	0.37	V
		$I_O = 1.9 \text{ mA}; V_{CC} = 1.65 \text{ V}$	-	-	0.35	V
		$I_O = 2.3 \text{ mA}; V_{CC} = 2.3 \text{ V}$	-	-	0.33	V
		$I_O = 3.1 \text{ mA}; V_{CC} = 2.3 \text{ V}$	-	-	0.45	V
		$I_O = 2.7 \text{ mA}; V_{CC} = 3.0 \text{ V}$	-	-	0.33	V
$I_I$	input leakage current	$V_I = \text{GND to } 3.6 \text{ V}; V_{CC} = 0 \text{ V to } 3.6 \text{ V}$	-	-	$\pm 0.5$	$\mu\text{A}$
		$V_I \text{ or } V_O = 0 \text{ V to } 3.6 \text{ V}; V_{CC} = 0 \text{ V}$	-	-	$\pm 0.5$	$\mu\text{A}$
$I_{OFF}$	power-off leakage current	$V_I \text{ or } V_O = 0 \text{ V to } 3.6 \text{ V}; V_{CC} = 0 \text{ V}$	-	-	$\pm 0.5$	$\mu\text{A}$

Symbol	Parameter	Conditions	Min	Typ	Max	Unit
$\Delta I_{OFF}$	additional power-off leakage current	$V_I$ or $V_O = 0$ V to 3.6 V; $V_{CC} = 0$ V to 0.2 V	-	-	$\pm 0.6$	$\mu$ A
$I_{CC}$	supply current	$V_I = GND$ or $V_{CC}$ ; $I_O = 0$ A; $V_{CC} = 0.8$ V to 3.6 V	-	-	0.9	$\mu$ A
$\Delta I_{CC}$	additional supply current	$V_I = V_{CC} - 0.6$ V; $I_O = 0$ A; $V_{CC} = 3.3$ V [1]	-	-	50	$\mu$ A
<b><math>T_{amb} = -40</math> °C to <math>+125</math> °C</b>						
$V_{IH}$	HIGH-level input voltage	$V_{CC} = 0.8$ V	$0.75 \times V_{CC}$	-	-	V
		$V_{CC} = 0.9$ V to 1.95 V	$0.70 \times V_{CC}$	-	-	V
		$V_{CC} = 2.3$ V to 2.7 V	1.6	-	-	V
		$V_{CC} = 3.0$ V to 3.6 V	2.0	-	-	V
$V_{IL}$	LOW-level input voltage	$V_{CC} = 0.8$ V	-	-	$0.25 \times V_{CC}$	V
		$V_{CC} = 0.9$ V to 1.95 V	-	-	$0.30 \times V_{CC}$	V
		$V_{CC} = 2.3$ V to 2.7 V	-	-	0.7	V
		$V_{CC} = 3.0$ V to 3.6 V	-	-	0.9	V
$V_{OH}$	HIGH-level output voltage	$V_I = V_{IH}$ or $V_{IL}$				
		$I_O = -20$ $\mu$ A; $V_{CC} = 0.8$ V to 3.6 V	$V_{CC} - 0.11$	-	-	V
		$I_O = -1.1$ mA; $V_{CC} = 1.1$ V	$0.6 \times V_{CC}$	-	-	V
		$I_O = -1.7$ mA; $V_{CC} = 1.4$ V	0.93	-	-	V
		$I_O = -1.9$ mA; $V_{CC} = 1.65$ V	1.17	-	-	V
		$I_O = -2.3$ mA; $V_{CC} = 2.3$ V	1.77	-	-	V
		$I_O = -3.1$ mA; $V_{CC} = 2.3$ V	1.67	-	-	V
		$I_O = -2.7$ mA; $V_{CC} = 3.0$ V	2.40	-	-	V
$I_O = -4.0$ mA; $V_{CC} = 3.0$ V	2.30	-	-	V		



Symbol	Parameter	Conditions	Min	Typ	Max	Unit
V <sub>OL</sub>	LOW-level output voltage	V <sub>I</sub> = V <sub>IH</sub> or V <sub>IL</sub>				
		I <sub>O</sub> = 20 μA; V <sub>CC</sub> = 0.8 V to 3.6 V	-	-	0.11	V
		I <sub>O</sub> = 1.1 mA; V <sub>CC</sub> = 1.1 V	-	-	0.33 × V <sub>CC</sub>	V
		I <sub>O</sub> = 1.7 mA; V <sub>CC</sub> = 1.4 V	-	-	0.41	V
		I <sub>O</sub> = 1.9 mA; V <sub>CC</sub> = 1.65 V	-	-	0.39	V
		I <sub>O</sub> = 2.3 mA; V <sub>CC</sub> = 2.3 V	-	-	0.36	V
		I <sub>O</sub> = 3.1 mA; V <sub>CC</sub> = 2.3 V	-	-	0.50	V
		I <sub>O</sub> = 2.7 mA; V <sub>CC</sub> = 3.0 V	-	-	0.36	V
		I <sub>O</sub> = 4.0 mA; V <sub>CC</sub> = 3.0 V	-	-	0.50	V
I <sub>I</sub>	input leakage current	V <sub>I</sub> = GND to 3.6 V; V <sub>CC</sub> = 0 V to 3.6 V	-	-	±0.75	μA
I <sub>OFF</sub>	power-off leakage current	V <sub>I</sub> or V <sub>O</sub> = 0 V to 3.6 V; V <sub>CC</sub> = 0 V	-	-	±0.75	μA
ΔI <sub>OFF</sub>	additional power-off leakage current	V <sub>I</sub> or V <sub>O</sub> = 0 V to 3.6 V; V <sub>CC</sub> = 0 V to 0.2 V	-	-	±0.75	μA
I <sub>CC</sub>	supply current	V <sub>I</sub> = GND or V <sub>CC</sub> ; I <sub>O</sub> = 0 A; V <sub>CC</sub> = 0.8 V to 3.6 V	-	-	1.4	μA
ΔI <sub>CC</sub>	additional supply current	V <sub>I</sub> = V <sub>CC</sub> - 0.6 V; I <sub>O</sub> = 0 A; V <sub>CC</sub> = 3.3 V <sup>[1]</sup>	-	-	75	μA

[1] One input at V<sub>CC</sub> - 0.6 V, other input at V<sub>CC</sub> or GND.

## 11 Dynamic characteristics

**Table 8. Dynamic characteristics**

Voltages are referenced to GND (ground = 0 V); for test circuit see [Figure 11](#).

Symbol	Parameter	Conditions	T <sub>amb</sub> = 25 °C			T <sub>amb</sub> = -40 °C to +125 °C				Unit
			Min	Typ <sup>[1]</sup>	Max	Min	Max (85 °C)	Min	Max (125 °C)	
<b>C<sub>L</sub> = 5 pF</b>										
t <sub>pd</sub>	propagation delay	A to Y; see <a href="#">Figure 10</a> <sup>[2]</sup>								
		V <sub>CC</sub> = 0.8 V	-	15.0	-	-	-	-	-	ns
		V <sub>CC</sub> = 1.1 V to 1.3 V	2.6	4.7	9.2	2.0	10.0	2.0	11.0	ns
		V <sub>CC</sub> = 1.4 V to 1.6 V	2.1	3.4	5.7	1.6	6.5	1.6	7.2	ns
		V <sub>CC</sub> = 1.65 V to 1.95 V	1.8	2.9	4.5	1.4	5.2	1.4	5.8	ns
		V <sub>CC</sub> = 2.3 V to 2.7 V	1.5	2.3	3.5	1.2	4.2	1.2	4.6	ns
		V <sub>CC</sub> = 3.0 V to 3.6 V	1.4	2.1	3.2	1.0	3.8	1.0	4.2	ns
<b>C<sub>L</sub> = 10 pF</b>										
t <sub>pd</sub>	propagation delay	A to Y; see <a href="#">Figure 10</a> <sup>[2]</sup>								
		V <sub>CC</sub> = 0.8 V	-	18.4	-	-	-	-	-	ns
		V <sub>CC</sub> = 1.1 V to 1.3 V	3.2	5.6	10.9	2.3	11.8	2.3	13.1	ns
		V <sub>CC</sub> = 1.4 V to 1.6 V	2.6	4.1	6.7	1.9	7.7	1.9	8.5	ns
		V <sub>CC</sub> = 1.65 V to 1.95 V	2.3	3.4	5.3	1.7	6.2	1.7	6.9	ns
		V <sub>CC</sub> = 2.3 V to 2.7 V	2.0	2.9	4.2	1.5	5.0	1.5	5.5	ns
		V <sub>CC</sub> = 3.0 V to 3.6 V	1.7	2.6	3.8	1.4	4.6	1.4	5.1	ns
<b>C<sub>L</sub> = 15 pF</b>										
t <sub>pd</sub>	propagation delay	A to Y; see <a href="#">Figure 10</a> <sup>[2]</sup>								
		V <sub>CC</sub> = 0.8 V	-	21.9	-	-	-	-	-	ns
		V <sub>CC</sub> = 1.1 V to 1.3 V	3.6	6.4	12.6	2.6	13.8	2.6	15.2	ns
		V <sub>CC</sub> = 1.4 V to 1.6 V	3.0	4.6	7.6	2.2	8.9	2.2	9.8	ns
		V <sub>CC</sub> = 1.65 V to 1.95 V	2.6	3.9	6.0	2.0	7.2	2.0	7.9	ns
		V <sub>CC</sub> = 2.3 V to 2.7 V	2.3	3.3	4.8	1.8	5.7	1.8	6.3	ns
		V <sub>CC</sub> = 3.0 V to 3.6 V	2.1	3.1	4.2	1.6	5.0	1.6	5.5	ns

Symbol	Parameter	Conditions	T <sub>amb</sub> = 25 °C			T <sub>amb</sub> = -40 °C to +125 °C				Unit
			Min	Typ <sup>[1]</sup>	Max	Min	Max (85 °C)	Min	Max (125 °C)	
<b>C<sub>L</sub> = 30 pF</b>										
t <sub>pd</sub>	propagation delay	A to Y; see <a href="#">Figure 10</a> <sup>[2]</sup>								
		V <sub>CC</sub> = 0.8 V	-	32.1	-	-	-	-	-	ns
		V <sub>CC</sub> = 1.1 V to 1.3 V	4.8	8.7	16.3	3.6	18.9	3.6	20.8	ns
		V <sub>CC</sub> = 1.4 V to 1.6 V	4.0	6.2	10.3	3.4	12.2	3.4	13.4	ns
		V <sub>CC</sub> = 1.65 V to 1.95 V	3.6	5.2	8.1	3.2	9.8	3.2	10.8	ns
		V <sub>CC</sub> = 2.3 V to 2.7 V	3.0	4.4	6.4	2.7	7.7	2.7	8.5	ns
		V <sub>CC</sub> = 3.0 V to 3.6 V	2.9	4.2	5.6	2.5	6.5	2.5	7.2	ns
C <sub>PD</sub>	power dissipation capacitance	V <sub>I</sub> = GND to V <sub>CC</sub> ; f <sub>i</sub> = 1 MHz <sup>[3]</sup>								
		V <sub>CC</sub> = 0.8 V	-	2.5	-	-	-	-	-	pF
		V <sub>CC</sub> = 1.1 V to 1.3 V	-	2.6	-	-	-	-	-	pF
		V <sub>CC</sub> = 1.4 V to 1.6 V	-	2.7	-	-	-	-	-	pF
		V <sub>CC</sub> = 1.65 V to 1.95 V	-	2.9	-	-	-	-	-	pF
		V <sub>CC</sub> = 2.3 V to 2.7 V	-	3.4	-	-	-	-	-	pF
		V <sub>CC</sub> = 3.0 V to 3.6 V	-	4.0	-	-	-	-	pF	

[1] All typical values are measured at nominal V<sub>CC</sub>.

[2] t<sub>pd</sub> is the same as t<sub>PLH</sub> and t<sub>PHL</sub>.

[3] C<sub>PD</sub> is used to determine the dynamic power dissipation (P<sub>D</sub> in μW).

$$P_D = C_{PD} \times V_{CC}^2 \times f_i \times N + \Sigma(C_L \times V_{CC}^2 \times f_o) \text{ where:}$$

f<sub>i</sub> = input frequency in MHz;

f<sub>o</sub> = output frequency in MHz;

C<sub>L</sub> = output load capacitance in pF;

V<sub>CC</sub> = supply voltage in V;

N = number of inputs switching;

Σ(C<sub>L</sub> × V<sub>CC</sub><sup>2</sup> × f<sub>o</sub>) = sum of outputs.

11.1 Waveform and test circuit

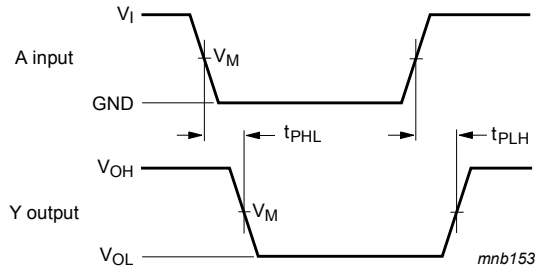

Measurement points are given in [Table 9](#).

$V_{OL}$  and  $V_{OH}$  are typical output voltage levels that occur with the output load.

Figure 10. The data input (A) to output (Y) propagation delays

Table 9. Measurement points

Supply voltage	Output	Input		
$V_{CC}$	$V_M$	$V_M$	$V_I$	$t_r = t_f$
0.8 V to 3.6 V	$0.5 \times V_{CC}$	$0.5 \times V_{CC}$	$V_{CC}$	$\leq 3.0$ ns

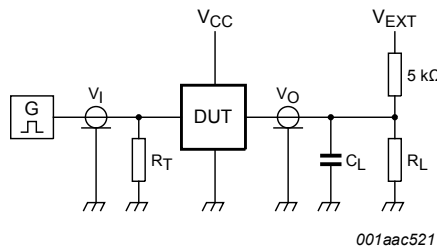

Test data is given in [Table 10](#).

Definitions for test circuit:

$R_L$  = Load resistance.

$C_L$  = Load capacitance including jig and probe capacitance.

$R_T$  = Termination resistance should be equal to the output impedance  $Z_o$  of the pulse generator.

$V_{EXT}$  = External voltage for measuring switching times.

Figure 11. Test circuit for measuring switching times

Table 10. Test data

Supply voltage	Load		$V_{EXT}$		
$V_{CC}$	$C_L$	$R_L$ [1]	$t_{PLH}, t_{PHL}$	$t_{PZH}, t_{PHZ}$	$t_{PZL}, t_{PLZ}$
0.8 V to 3.6 V	5 pF, 10 pF, 15 pF and 30 pF	5 kΩ or 1 MΩ	open	GND	$2 \times V_{CC}$

[1] For measuring enable and disable times  $R_L = 5$  kΩ, for measuring propagation delays, setup and hold times and pulse width  $R_L = 1$  MΩ.

12 Package outline

TSSOP5: plastic thin shrink small outline package; 5 leads; body width 1.25 mm

SOT353-1

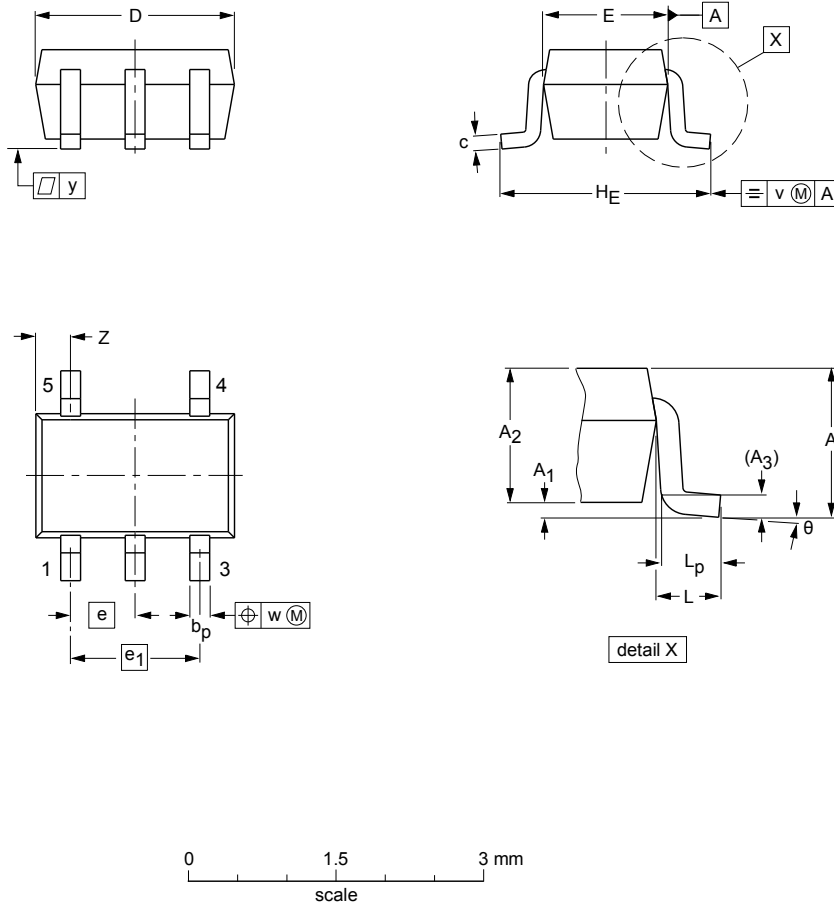

DIMENSIONS (mm are the original dimensions)

UNIT	A max.	A <sub>1</sub>	A <sub>2</sub>	A <sub>3</sub>	b <sub>p</sub>	c	D <sup>(1)</sup>	E <sup>(1)</sup>	e	e <sub>1</sub>	H <sub>E</sub>	L	L <sub>p</sub>	v	w	y	Z <sup>(1)</sup>	θ
mm	1.1	0.1 0	1.0 0.8	0.15	0.30 0.15	0.25 0.08	2.25 1.85	1.35 1.15	0.65	1.3	2.25 2.0	0.425	0.46 0.21	0.3	0.1	0.1	0.60 0.15	7° 0°

Note

1. Plastic or metal protrusions of 0.15 mm maximum per side are not included.

OUTLINE VERSION	REFERENCES			EUROPEAN PROJECTION	ISSUE DATE
	IEC	JEDEC	JEITA		
SOT353-1		MO-203	SC-88A		00-09-01 03-02-19

Figure 12. Package outline SOT353-1 (TSSOP5)

XSON6: plastic extremely thin small outline package; no leads; 6 terminals; body 1 x 1.45 x 0.5 mm

SOT886

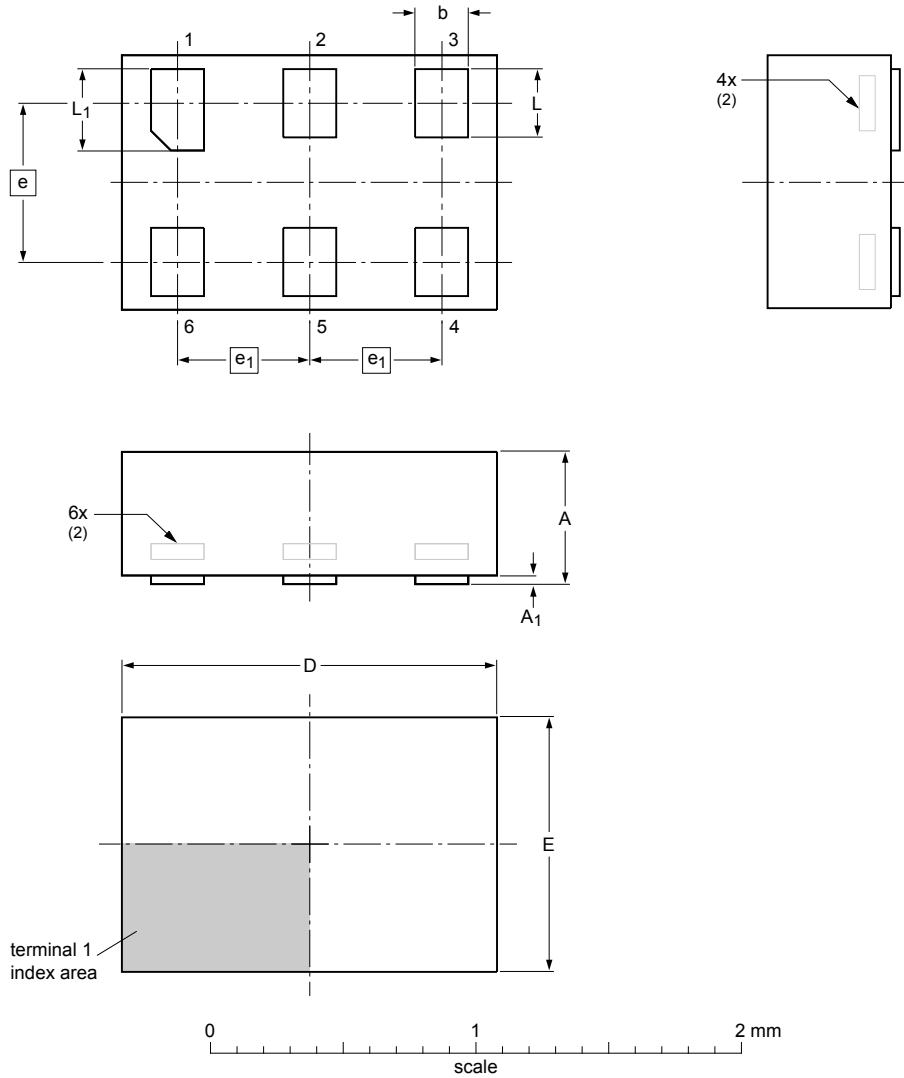

Dimensions (mm are the original dimensions)

Unit	A <sup>(1)</sup>	A <sub>1</sub>	b	D	E	e	e <sub>1</sub>	L	L <sub>1</sub>
mm	max 0.5	0.04	0.25	1.50	1.05			0.35	0.40
	nom		0.20	1.45	1.00	0.6	0.5	0.30	0.35
	min		0.17	1.40	0.95			0.27	0.32

Notes

- Including plating thickness.
- Can be visible in some manufacturing processes.

sot886\_po

Outline version	References			European projection	Issue date
	IEC	JEDEC	JEITA		
SOT886		MO-252			04-07-22 12-01-05

Figure 13. Package outline SOT886 (XSON6)

XSON6: plastic extremely thin small outline package; no leads; 6 terminals; body 1 x 1 x 0.5 mm

SOT891

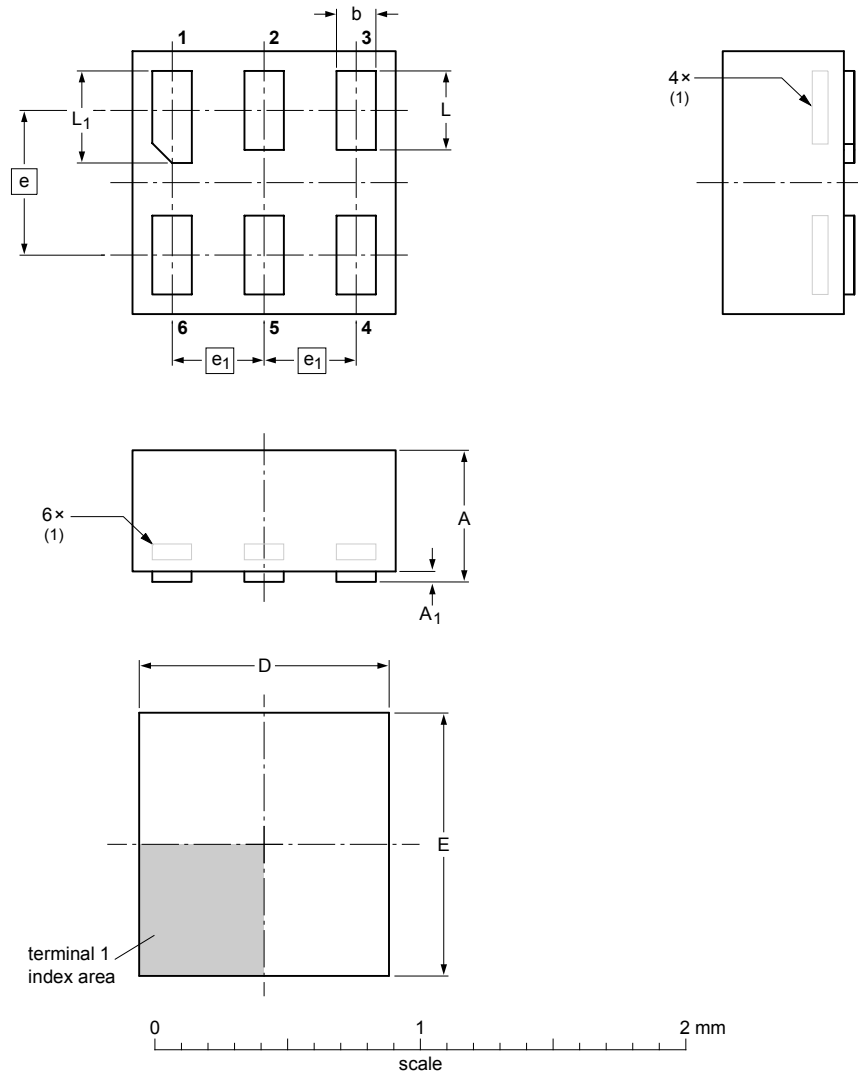

**DIMENSIONS (mm are the original dimensions)**

UNIT	A max	A <sub>1</sub> max	b	D	E	e	e <sub>1</sub>	L	L <sub>1</sub>
mm	0.5	0.04	0.20 0.12	1.05 0.95	1.05 0.95	0.55	0.35	0.35 0.27	0.40 0.32

**Note**

1. Can be visible in some manufacturing processes.

OUTLINE VERSION	REFERENCES			EUROPEAN PROJECTION	ISSUE DATE
	IEC	JEDEC	JEITA		
SOT891					-05-04-06 07-05-15

Figure 14. Package outline SOT891 (XSON6)

**XSON6: extremely thin small outline package; no leads;  
6 terminals; body 0.9 x 1.0 x 0.35 mm**

SOT1115

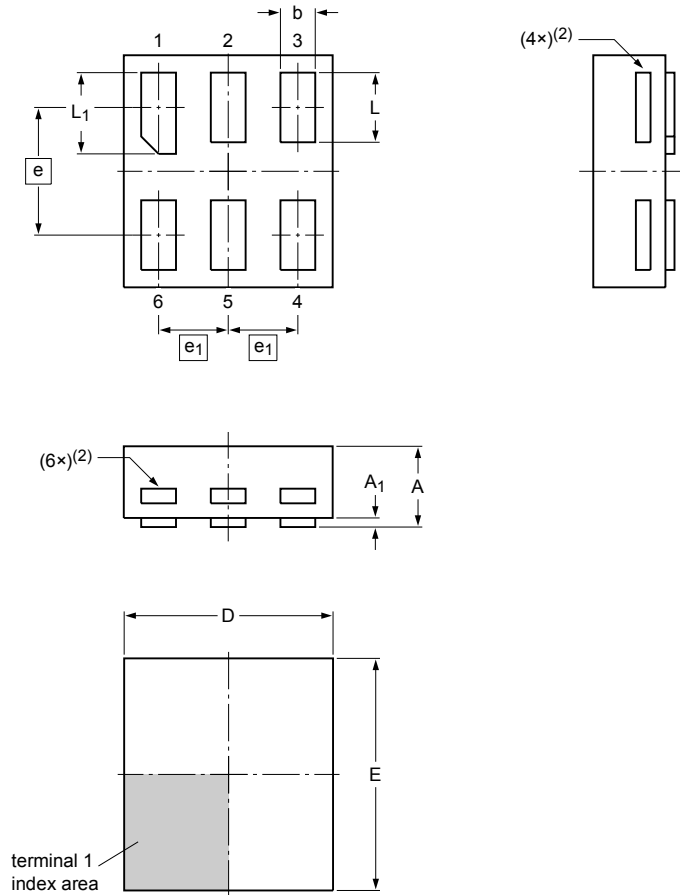

Dimensions

Unit	A <sup>(1)</sup>	A <sub>1</sub>	b	D	E	e	e <sub>1</sub>	L	L <sub>1</sub>
mm	max 0.35	0.04	0.20	0.95	1.05			0.35	0.40
	nom		0.15	0.90	1.00	0.55	0.3	0.30	0.35
	min		0.12	0.85	0.95			0.27	0.32

Note

- Including plating thickness.
- Visible depending upon used manufacturing technology.

sot1115\_po

Outline version	References				European projection	Issue date
	IEC	JEDEC	JEITA			
SOT1115						-10-04-02- 10-04-07

Figure 15. Package outline SOT1115 (XSON6)



**XSON6: extremely thin small outline package; no leads;  
6 terminals; body 1.0 x 1.0 x 0.35 mm**

SOT1202



Dimensions

Unit	A <sup>(1)</sup>	A <sub>1</sub>	b	D	E	e	e <sub>1</sub>	L	L <sub>1</sub>
mm	max 0.35	0.04	0.20	1.05	1.05	0.35	0.30	0.35	0.40
	nom 0.15	1.00	1.00	0.55	0.35	0.30	0.35		
	min 0.12	0.95	0.95			0.27	0.32		

Note

- 1. Including plating thickness.
- 2. Visible depending upon used manufacturing technology.

sot1202\_po

Outline version	References				European projection	Issue date
	IEC	JEDEC	JEITA			
SOT1202						-10-04-02- 10-04-06

Figure 16. Package outline SOT1202 (XSON6)

**X2SON5: plastic thermal enhanced extremely thin small outline package; no leads;**  
**5 terminals; body 0.8 x 0.8 x 0.35 mm**

SOT1226

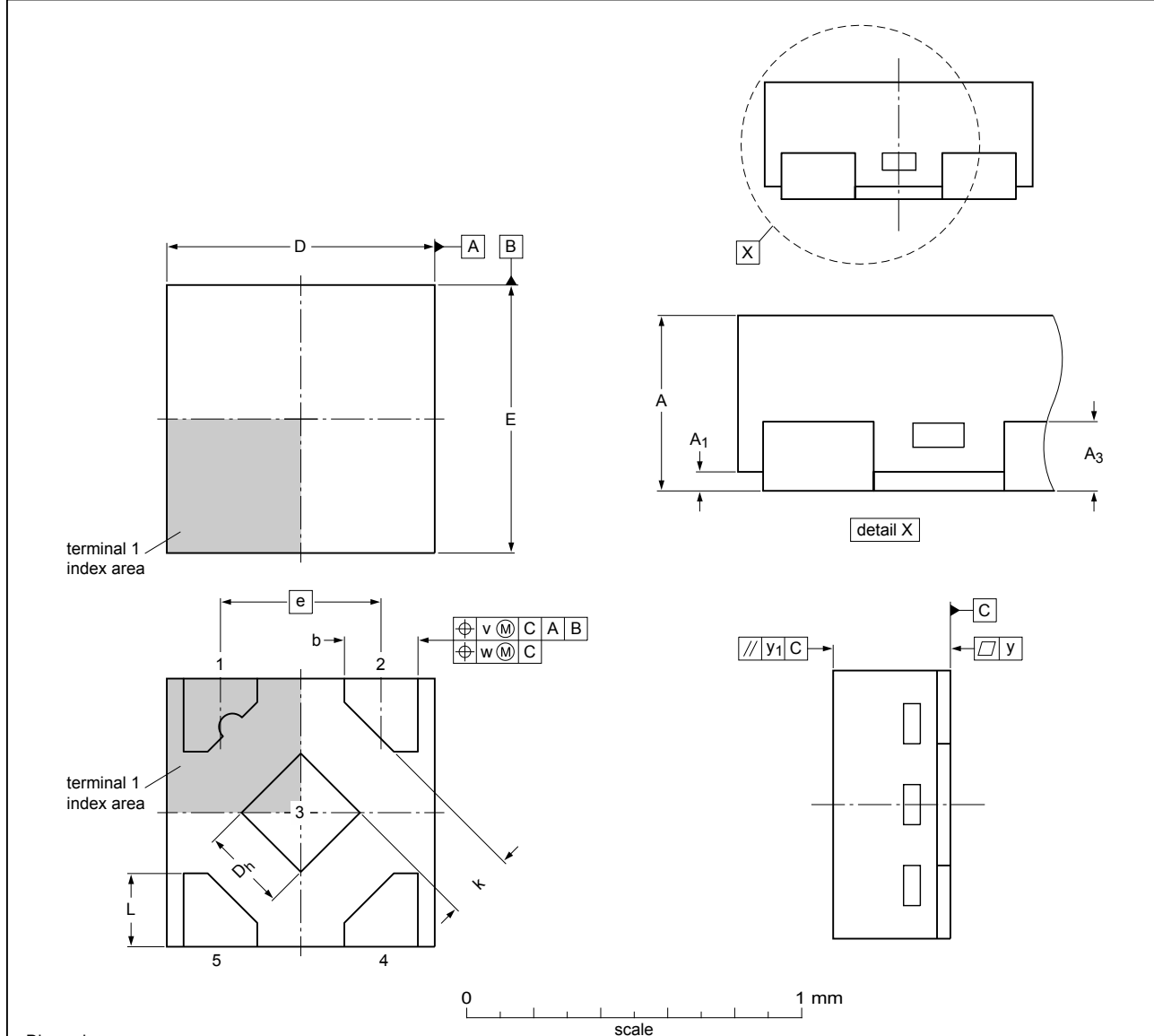

Dimensions

Unit	A <sup>(1)</sup>	A <sub>1</sub>	A <sub>3</sub>	D	D <sub>h</sub>	E	b	e	k	L	v	w	y	y <sub>1</sub>
max	0.35	0.04	0.128	0.85	0.30	0.85	0.27			0.27				
mm nom				0.80	0.25	0.80	0.22	0.48		0.22	0.1	0.05	0.05	0.05
min			0.040	0.75	0.20	0.75	0.17		0.20	0.17				

Note

1. Dimension A is including plating thickness.
2. Plastic or metal protrusions of 0.075 mm maximum per side are not included.

sot1226\_po

Outline version	References				European projection	Issue date
	IEC	JEDEC	EIAJ			
SOT1226						12-04-10 12-04-25

Figure 17. Package outline SOT1226 (X2SON5)

X2SON4: plastic thermal enhanced extremely thin small outline package; no leads;  
4 terminals; body 0.6 x 0.6 x 0.32 mm

SOT1269-2

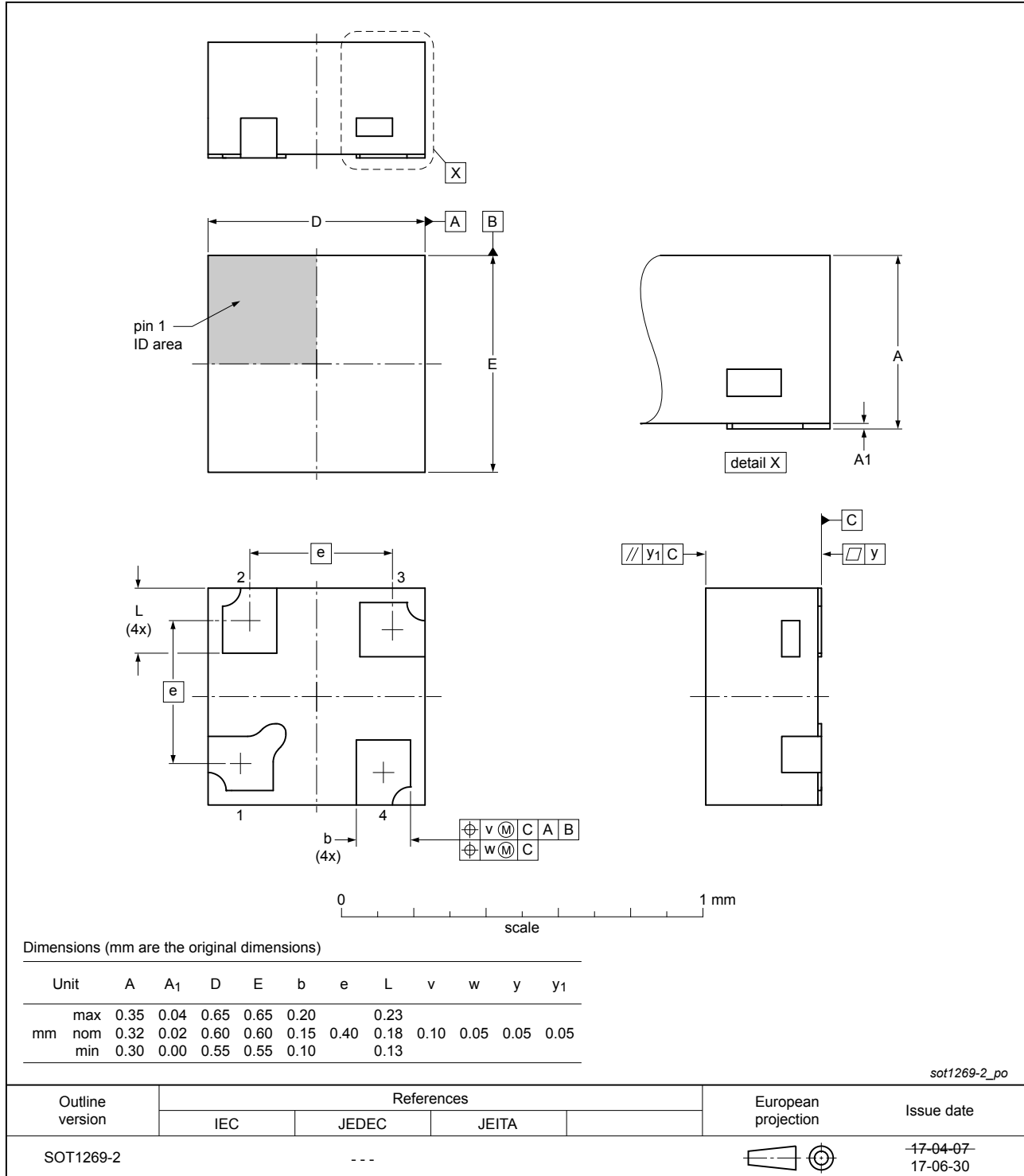

Figure 18. Package outline SOT1269-2 (X2SON4)

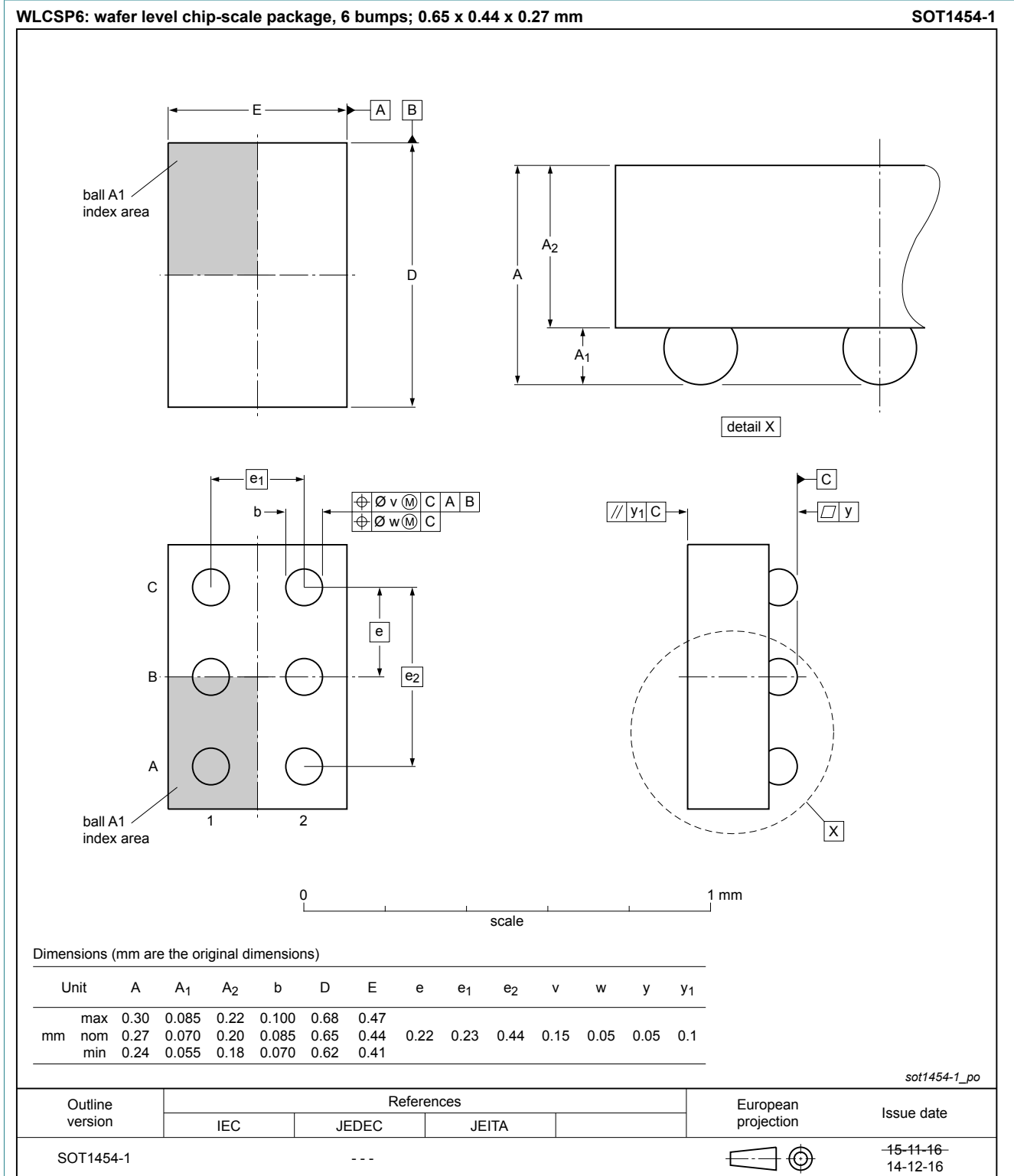

Figure 19. Package outline SOT1454-1 (WLCSP6)

## 13 Abbreviations

Table 11. Abbreviations

Acronym	Description
CDM	Charged Device Model
DUT	Device Under Test
ESD	ElectroStatic Discharge
HBM	Human Body Model
MM	Machine Model

## 14 Revision history

Table 12. Revision history

Document ID	Release date	Data sheet status	Change notice	Supersedes
74AUP1G34 v.8	20180608	Product data sheet	-	74AUP1G34 v.7
Modifications:	<ul style="list-style-type: none"> <li>Added type number 74AUP1G34GX4 (SOT1269-2)</li> </ul>			
74AUP1G34 v.7	20170328	Product data sheet	-	74AUP1G34 v.6
Modifications:	<ul style="list-style-type: none"> <li>Added type number 74AUP1G34UK (SOT1454-1/WLCSP6)</li> </ul>			
74AUP1G34 v.6	20120628	Product data sheet	-	74AUP1G34 v.5
Modifications:	<ul style="list-style-type: none"> <li>Added type number 74AUP1G34GX (SOT1226)</li> <li>Package outline drawing of SOT886 (<a href="#">Figure 13</a>) modified.</li> </ul>			
74AUP1G34 v.5	20111128	Product data sheet	-	74AUP1G34 v.4
Modifications:	<ul style="list-style-type: none"> <li>Legal pages updated.</li> </ul>			
74AUP1G34 v.4	20100714	Product data sheet	-	74AUP1G34 v.3
74AUP1G34 v.3	20080814	Product data sheet	-	74AUP1G34 v.2
74AUP1G34 v.2	20060704	Product data sheet	-	74AUP1G34 v.1
74AUP1G34 v.1	20050804	Product data sheet	-	-

## 15 Legal information

### 15.1 Data sheet status

Document status <sup>[1][2]</sup>	Product status <sup>[3]</sup>	Definition
Objective [short] data sheet	Development	This document contains data from the objective specification for product development.
Preliminary [short] data sheet	Qualification	This document contains data from the preliminary specification.
Product [short] data sheet	Production	This document contains the product specification.

[1] Please consult the most recently issued document before initiating or completing a design.

[2] The term 'short data sheet' is explained in section "Definitions".

[3] The product status of device(s) described in this document may have changed since this document was published and may differ in case of multiple devices. The latest product status information is available on the Internet at URL <http://www.nexperia.com>.

### 15.2 Definitions

**Draft** — The document is a draft version only. The content is still under internal review and subject to formal approval, which may result in modifications or additions. Nexperia does not give any representations or warranties as to the accuracy or completeness of information included herein and shall have no liability for the consequences of use of such information.

**Short data sheet** — A short data sheet is an extract from a full data sheet with the same product type number(s) and title. A short data sheet is intended for quick reference only and should not be relied upon to contain detailed and full information. For detailed and full information see the relevant full data sheet, which is available on request via the local Nexperia sales office. In case of any inconsistency or conflict with the short data sheet, the full data sheet shall prevail.

**Product specification** — The information and data provided in a Product data sheet shall define the specification of the product as agreed between Nexperia and its customer, unless Nexperia and customer have explicitly agreed otherwise in writing. In no event however, shall an agreement be valid in which the Nexperia product is deemed to offer functions and qualities beyond those described in the Product data sheet.

### 15.3 Disclaimers

**Limited warranty and liability** — Information in this document is believed to be accurate and reliable. However, Nexperia does not give any representations or warranties, expressed or implied, as to the accuracy or completeness of such information and shall have no liability for the consequences of use of such information. Nexperia takes no responsibility for the content in this document if provided by an information source outside of Nexperia. In no event shall Nexperia be liable for any indirect, incidental, punitive, special or consequential damages (including - without limitation - lost profits, lost savings, business interruption, costs related to the removal or replacement of any products or rework charges) whether or not such damages are based on tort (including negligence), warranty, breach of contract or any other legal theory. Notwithstanding any damages that customer might incur for any reason whatsoever, Nexperia's aggregate and cumulative liability towards customer for the products described herein shall be limited in accordance with the Terms and conditions of commercial sale of Nexperia.

**Right to make changes** — Nexperia reserves the right to make changes to information published in this document, including without limitation specifications and product descriptions, at any time and without notice. This document supersedes and replaces all information supplied prior to the publication hereof.

**Suitability for use** — Nexperia products are not designed, authorized or warranted to be suitable for use in life support, life-critical or safety-critical

systems or equipment, nor in applications where failure or malfunction of an Nexperia product can reasonably be expected to result in personal injury, death or severe property or environmental damage. Nexperia and its suppliers accept no liability for inclusion and/or use of Nexperia products in such equipment or applications and therefore such inclusion and/or use is at the customer's own risk.

**Applications** — Applications that are described herein for any of these products are for illustrative purposes only. Nexperia makes no representation or warranty that such applications will be suitable for the specified use without further testing or modification. Customers are responsible for the design and operation of their applications and products using Nexperia products, and Nexperia accepts no liability for any assistance with applications or customer product design. It is customer's sole responsibility to determine whether the Nexperia product is suitable and fit for the customer's applications and products planned, as well as for the planned application and use of customer's third party customer(s). Customers should provide appropriate design and operating safeguards to minimize the risks associated with their applications and products. Nexperia does not accept any liability related to any default, damage, costs or problem which is based on any weakness or default in the customer's applications or products, or the application or use by customer's third party customer(s). Customer is responsible for doing all necessary testing for the customer's applications and products using Nexperia products in order to avoid a default of the applications and the products or of the application or use by customer's third party customer(s). Nexperia does not accept any liability in this respect.

**Limiting values** — Stress above one or more limiting values (as defined in the Absolute Maximum Ratings System of IEC 60134) will cause permanent damage to the device. Limiting values are stress ratings only and (proper) operation of the device at these or any other conditions above those given in the Recommended operating conditions section (if present) or the Characteristics sections of this document is not warranted. Constant or repeated exposure to limiting values will permanently and irreversibly affect the quality and reliability of the device.

**Terms and conditions of commercial sale** — Nexperia products are sold subject to the general terms and conditions of commercial sale, as published at <http://www.nexperia.com/profile/terms>, unless otherwise agreed in a valid written individual agreement. In case an individual agreement is concluded only the terms and conditions of the respective agreement shall apply. Nexperia hereby expressly objects to applying the customer's general terms and conditions with regard to the purchase of Nexperia products by customer.

**No offer to sell or license** — Nothing in this document may be interpreted or construed as an offer to sell products that is open for acceptance or the grant, conveyance or implication of any license under any copyrights, patents or other industrial or intellectual property rights.

**Export control** — This document as well as the item(s) described herein may be subject to export control regulations. Export might require a prior authorization from competent authorities.

**Non-automotive qualified products** — Unless this data sheet expressly states that this specific Nexperia product is automotive qualified, the product is not suitable for automotive use. It is neither qualified nor tested in accordance with automotive testing or application requirements. Nexperia accepts no liability for inclusion and/or use of non-automotive qualified products in automotive equipment or applications. In the event that customer uses the product for design-in and use in automotive applications to automotive specifications and standards, customer (a) shall use the product without Nexperia's warranty of the product for such automotive applications, use and specifications, and (b) whenever customer uses the product for automotive applications beyond Nexperia's specifications such use shall be solely at customer's own risk, and (c) customer fully indemnifies Nexperia for any liability, damages or failed product claims resulting from customer

design and use of the product for automotive applications beyond Nexperia's standard warranty and Nexperia's product specifications.

**Translations** — A non-English (translated) version of a document is for reference only. The English version shall prevail in case of any discrepancy between the translated and English versions.

## 15.4 Trademarks

Notice: All referenced brands, product names, service names and trademarks are the property of their respective owners.

## Contents

1	General description .....	1
2	Features and benefits .....	1
3	Ordering information .....	2
4	Marking .....	2
5	Functional diagram .....	3
6	Pinning information .....	3
6.1	Pinning .....	3
6.2	Pin description .....	4
7	Functional description .....	4
8	Limiting values .....	5
9	Recommended operating conditions .....	5
10	Static characteristics .....	6
11	Dynamic characteristics .....	10
11.1	Waveform and test circuit .....	12
12	Package outline .....	13
13	Abbreviations .....	21
14	Revision history .....	21
15	Legal information .....	22

---

Please be aware that important notices concerning this document and the product(s) described herein, have been included in section 'Legal information'.

---

© Nexperia B.V. 2018.

All rights reserved.

For more information, please visit: <http://www.nexperia.com>

For sales office addresses, please send an email to: [salesaddresses@nexperia.com](mailto:salesaddresses@nexperia.com)

Date of release: 8 June 2018  
Document identifier: 74AUP1G34