

N ATTENUATOR
6 DB 8 GHZ 12W

R415.706.000
Series : ATTENUATOR

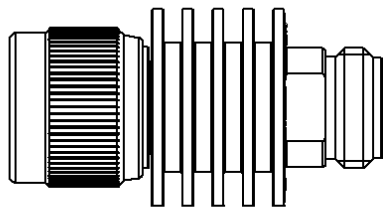

SCALE 1:1

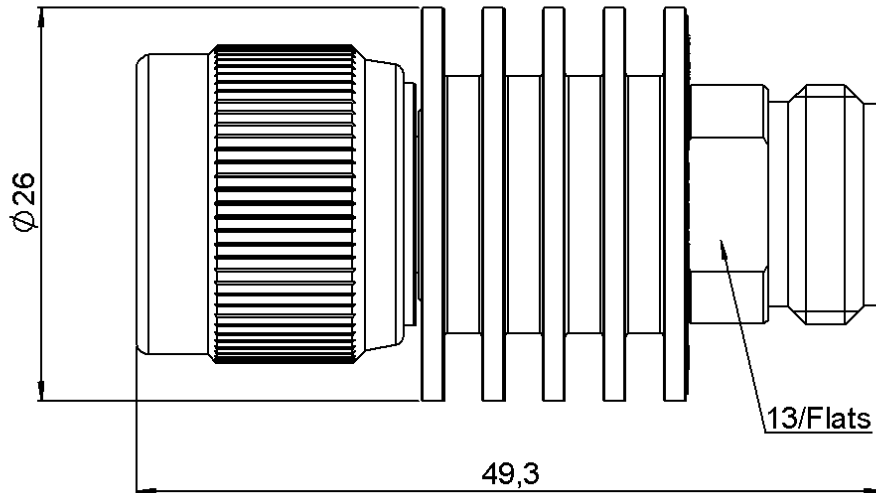
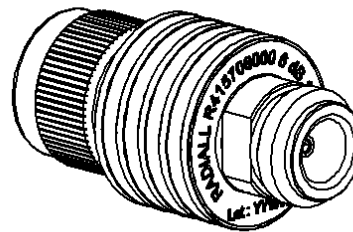

All dimensions are in mm.



COMPONENTS	MATERIALS	PLATING(μm)
BODY	BRASS	NICKEL 5
MALE CENTER CONTACT	BRASS	GOLD 2.5 OVER NICKEL 1
FEMALE CENTER CONTACT	BERYLLIUM COPPER	GOLD 2.5 OVER NICKEL 2.5
OUTER CONTACT	BRASS	NICKEL 2
INSULATOR	PTFE	
GASKET	SILICONE RUBBER	
SUBSTRATE	ALUMINIUM NITRIDE	
RESISTOR	THIN FILM	
OTHERS PARTS	ALUMINIUM	BLACK ANODIZATION

Issue : 0829 /

In the effort to improve our products, we reserve the right to make changes judged to be necessary.



N ATTENUATOR
6 DB 8 GHZ 12W

R415.706.000
 Series : ATTENUATOR

ELECTRICAL CHARACTERISTICS

Frequency (GHz)	DC - 4	4 - 8
V.S.W.R (≤)	1.15	1.25
Deviation(±dB)	0.30	0.30

Operating Frequency Range	DC - 8	GHz
Impedance	50	Ω
Nominal Attenuation	6	dB
Peak power at 25°C (1μs, 1%)	250	W
Average power at 25°C	12	W (Free Air Cooled)
		W (Conduction Cooled)

MECHANICAL CHARACTERISTICS

Connectors	N	Male Female	MIL-C 39012
Weight	67,4900 g		

ENVIRONMENTAL CHARACTERISTICS

Operating temperature range	-55 /+125 °C
Storage temperature range	-55 /+125 °C

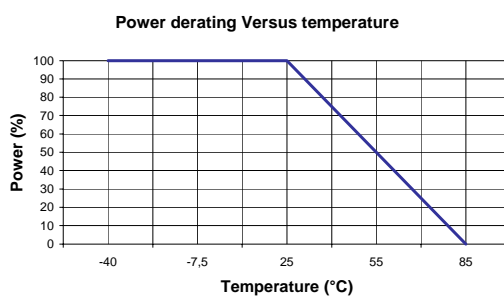

SPECIFICATION

OTHER CHARACTERISTICS

Issue : 0829 /

In the effort to improve our products, we reserve the right to make changes judged to be necessary.

