



Detector

Slide

Push

Rotary

Power

Dual-in-line Package Type

Horizontal Type

Vertical Type

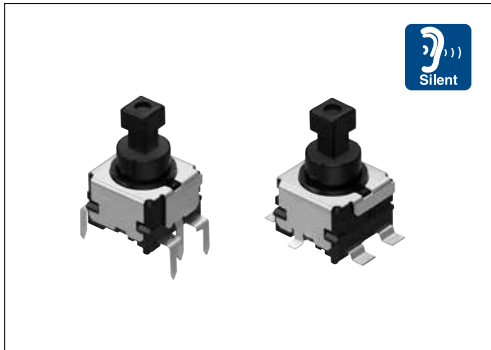

Typical Specifications

Items	Specifications
Rating (max.)/(min.) (Resistive load)	1A 14.5V DC / 50μA 3V DC
Contact resistance (Initial / After operating life)	100mΩ max. / 100mΩ max.
Operating force	3N, 5N
Operating life (With load)	30,000 cycles (1A 14.5V DC)
Poles-position	1-pole, 2-position

Product Line

Changeover timing	Travel (mm)	Total travel (mm)	Operating force	Mounting method	Operating	Terminal type	Minimum order unit (pcs.)		Product No.	Drawing No.	
							Japan	Export			
Non shorting	1.5	2.7	3N	PC board	Latching	Reflow	660	1,320	SPEF210101	1	
						Dip	1,050	4,200	SPEF110100	2	
			Reflow			660	1,320	SPEF210200	1		
			Dip			1,050	4,200	SPEF110200	2		
	-		5N		3N	Alternate	Reflow	660	1,320	SPEF220100	1
							Dip	1,050	4,200	SPEF120100	2
					5N		Reflow	660	1,320	SPEF220200	1
							Dip	1,050	4,200	SPEF120200	2

Packing Specifications

Taping

Product No.	Number of packages (pcs.)			Tape width (mm)	Export package measurements (mm)
	1 reel	1 case / Japan	1 case / export packing		
SPEF210101 SPEF210200 SPEF220100 SPEF220200	165	660	1,320	32	403×403×360

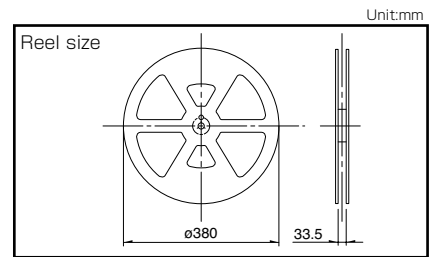

Tray

Product No.	Number of packages (pcs.)		Export package measurements (mm)
	1 case / Japan	1 case / export packing	
SPEF110100 SPEF110200 SPEF120100 SPEF120200	1,050	4,200	540×360×230

Refer to P.130 for soldering conditions.

■ Dimensions

Unit:mm

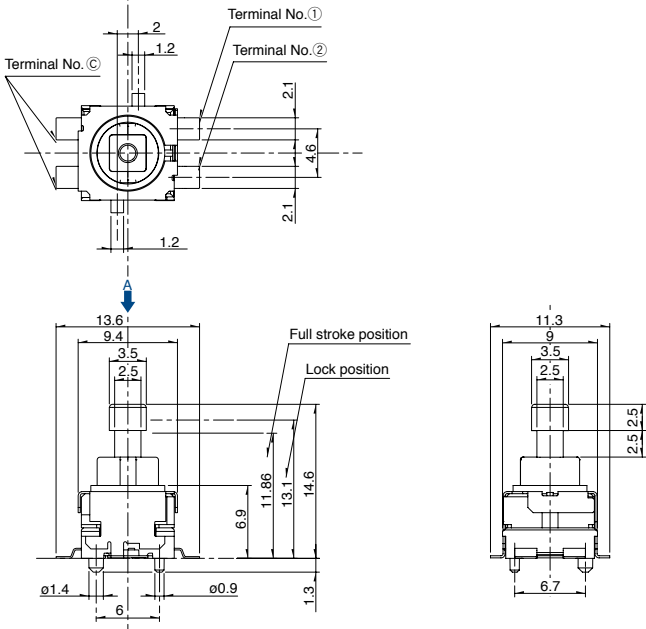
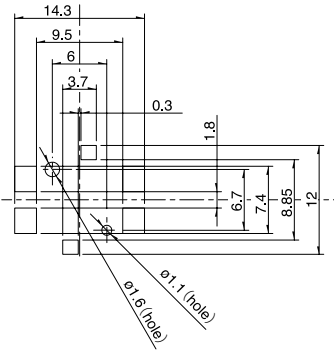
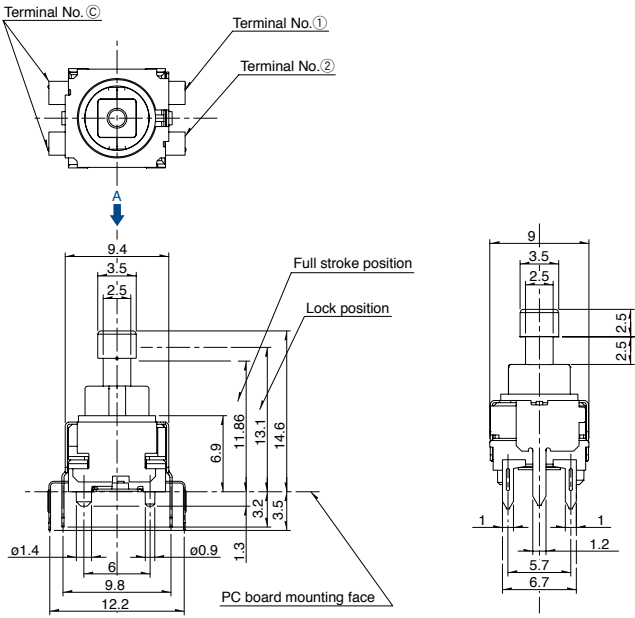
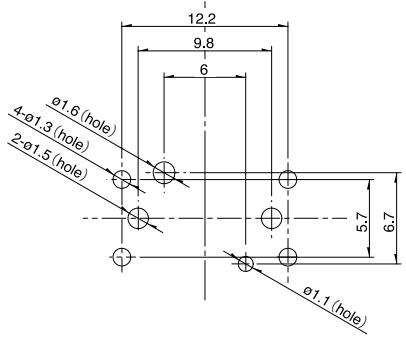
No.	Style	PC board mounting hole dimensions (Viewed from the direction A)
1	<p>Reflow soldering type</p>  <p>Terminal No. ① Terminal No. ② Terminal No. ③</p> <p>Full stroke position Lock position</p> <p>PC board mounting face</p>	 <p>14.3 9.5 6 3.7 0.3 1.8 6.7 7.4 8.85 12 2.5 2.5 6.7 11.3 9 3.5 2.5</p> <p>$\phi 1.5$ (hole) $\phi 1.1$ (hole)</p>
2	<p>Dip soldering type</p>  <p>Terminal No. ③ Terminal No. ① Terminal No. ②</p> <p>Full stroke position Lock position</p> <p>PC board mounting face</p>	 <p>12.2 9.8 6 5.7 6.7 1 1 5.7 6.7 2.5 2.5 9 3.5 2.5</p> <p>$\phi 1.6$ (hole) 4-$\phi 1.3$ (hole) 2-$\phi 1.5$ (hole) $\phi 1.1$ (hole)</p>



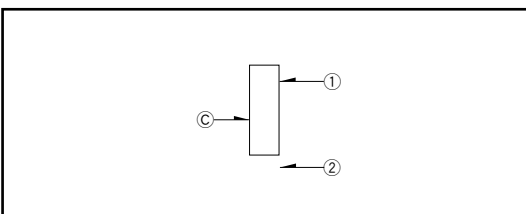







■ Circuit Diagram (Viewed from Direction A)

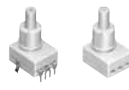

Detector
Slide
Push
Rotary
Power
Dual-in-line
Package Type
Horizontal
Type
Vertical
Type

Push Switches

List of Varieties

Series		Vertical					
		SPEF		SPED2	SPED3	SPED4	SPED5
Photo							
Dimensions (mm)	W	9.4		14			13.5
	D	9		16.8	18		18.2
	H	6.9		18.3	13.2	13.1	14.3
Travel (mm)		1.5		—	—	—	—
Total travel (mm)		2.7		4.5	3.8		
Number of poles		1		1 2	1		
Operating temperature range		-40°C to +85°C			-40°C to +95°C		
Automotive use		●	●	●	●	●	●
Life cycle							
Rating (max.) (Resistive load)		1A 14.5V DC			2A 14.5V DC		
Rating (min.) (Resistive load)		50μA 3V DC		—	—	—	—
Durability	Operating life without load	—	—	—	—	—	—
	Operating life with load (at max. rated load)	30,000 cycles 100mΩ max.					
Electrical performance	Initial contact resistance	100mΩ max.					
	Insulation resistance	3MΩ min. 100V DC			3MΩ min. 500V DC		
	Voltage proof	100V AC for 1minute					
Mechanical performance	Terminal strength	—	—	—	—	—	Wire strength 30N
	Actuator strength	Operating direction			98N	90N	98N
		Pulling direction			30N	—	—
Environmental performance	Cold	-40°C 96h					
	Dry heat	85°C 96h		85°C 96h (Connector type) 105°C 192h (Dip type)	105°C 192h		
	Damp heat	40°C, 90 to 95%RH 96h					
Page		124		126	128		

Push Switches Soldering Conditions	130
Push Switches Cautions	131

Note
● Indicates applicability to all products in the series.

Example of Reflow Soldering Condition

1. Heating method: Double heating method with infrared heater.
2. Temperature measurement: Thermocouple ϕ 0.1 to 0.2 CA (K) or CC (T) at soldering portion (copper foil surface).
A heat resisting tape should be used for fixed measurement.
3. Temperature profile

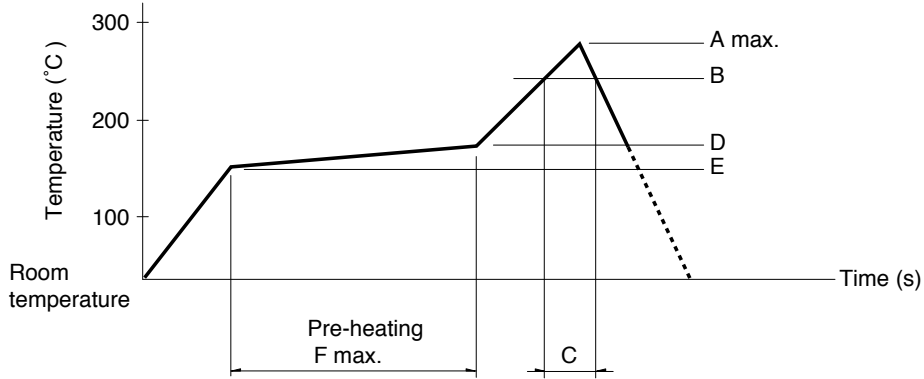

Series (Reflow type)	A (°C) 3s max.	B (°C)	C (s)	D (°C)	E (°C)	F (s)
SPEJ	260	230	40	180	150	120
SPEF						
SPEH						

Notes

1. The condition mentioned above is the temperature on the mounting surface of a PC board. There are cases where the PC board's temperature greatly differs from that of the switch, depending on the PC board's material, size, thickness, etc.
The above-stated conditions shall also apply to switch surface temperatures.
2. Soldering conditions differ depending on reflow soldering machines. Prior verification of soldering condition is highly recommended.

Reference for Hand Soldering

Series	Soldering temperature	Soldering time
SPPJ3, SPPJ2, SPUN, SPPH4, SPPH1	350±10°C	3+1/0s
SPED2, SPED4	350±10°C	3±0.5s
SPEJ	350±10°C	4s max.
SPEF	350±5°C	3s max.
SPEH	350°C max.	3s max.
SPUJ	300±10°C	3+1/0s

Reference for Dip Soldering

(For PC board terminal types)

Series	Items		Dip soldering	
	Preheating temperature	Preheating time	Soldering temperature	Duration of immersion
SPPJ3	100°C max.	60s max.	260±5°C	5±1s
SPUN	100°C max.	60s max.	260±5°C	10±1s
SPUJ, SPPH4	—		260±5°C	5±1s
SPPJ2, SPPH1, SPED2, SPED4, SPEF	—		260±5°C	10±1s