

for RF/Local

Chip Multilayer LC Filters (BPF)

● LFB15(0402)_CB Series



Frequency Characteristics

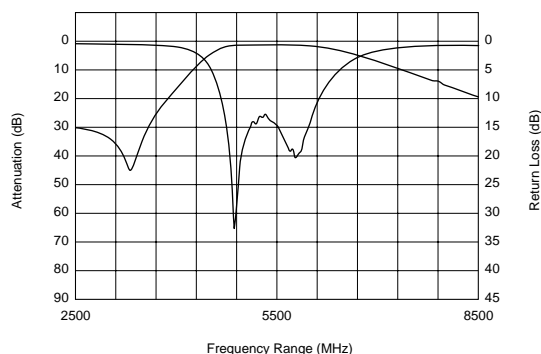

| Part Number | Nominal Center Frequency (fo) (MHz) | Bandwidth (BW) (MHz) | Insertion Loss in BW (dB) | Attenuation (Absolute Value I) (dB) | Attenuation (Absolute Value II) (dB) | Application |
|------------------|-------------------------------------|----------------------|---------------------------|-------------------------------------|--------------------------------------|-------------|
| LFB155G37CB1C032 | 5375 | fo±475 | 1.5 max. (at 25°C) | 10 min. at 3800MHz | 5 min. at 7500MHz | WLAN/BT |
| LFB155G50CB1B948 | 5500 | fo±350 | 1.1 max. (at 25°C) | 9.5 min. at 4000MHz | 4.5 min. at 7500MHz | WLAN/BT |

● LFB18(0603)_SG Series

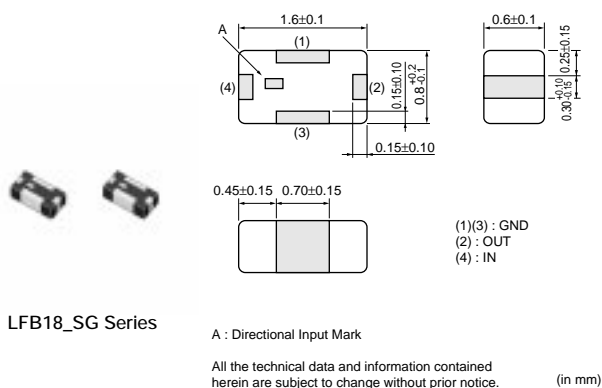

Frequency Characteristics



| Part Number | Nominal Center Frequency (fo) (MHz) | Bandwidth (BW) (MHz) | Insertion Loss in BW (dB) | Attenuation (Absolute Value I) (dB) | Attenuation (Absolute Value II) (dB) | Application |
|------------------|-------------------------------------|----------------------|---------------------------|-------------------------------------|--------------------------------------|-------------|
| LFB182G45SG9A213 | 2450 | fo±50 | 2.2 max. (at 25°C) | 24 min. at 880~960MHz | 20 min. at 1710~1990MHz | WLAN/BT |
| LFB182G45SG9A246 | 2450 | fo±50 | 2.2 max. (at 25°C) | 24.5 min. at 880~960MHz | 12.5 min. at 1710~1990MHz | WLAN/BT |
| LFB182G45SG9A272 | 2450 | fo±50 | 1.8 max. (at 25°C) | 25 min. at 880~1000MHz | 22.5 min. at 1200~1300MHz | WLAN/BT |
| LFB182G60SGHB972 | 2600 | fo±100.0 | 1.9 max. (at 25°C) | 29.5 min. at 806~849MHz | 25 min. at 1850~1910MHz | WIMAX |
| LFB182G60SGHC149 | 2600 | fo±100.0 | 2.2 max. (at 25°C) | 29.5 min. at 806~849MHz | 30 min. at 1850~1910MHz | WIMAX |
| LFB183G60SGJC019 | 3500 | fo±200 | 1.8 max. (at 25°C) | 25.5 min. at 806~849MHz | 21.5 min. at 1850~1910MHz | WIMAX |
| LFB185G78SGAB713 | 5787.5 | fo±62.5 | 2.2 max. (at 25°C) | 16.5 min. at 4800MHz | 23.5 min. at 11450~11700MHz | WLAN/BT |

△Note • This PDF catalog is downloaded from the website of Murata Manufacturing co., Ltd. Therefore, it's specifications are subject to change or our products in it may be discontinued without advance notice. Please check with our sales representatives or product engineers before ordering.
 • This PDF catalog has only typical specifications because there is no space for detailed specifications. Therefore, please approve our product specifications or transact the approval sheet for product specifications before ordering.

● LFB21(0805)_CG Series



Frequency Characteristics



| Part Number | Nominal Center Frequency (fo) (MHz) | Bandwidth (BW) (MHz) | Insertion Loss in BW (dB) | Attenuation (Absolute Value) I) (dB) | Attenuation (Absolute Value) II) (dB) | Application |
|------------------|-------------------------------------|----------------------|---------------------------|--------------------------------------|---------------------------------------|-------------|
| LFB212G45CG1C187 | 2450.00 | fo±50.00 | 0.90 max. (at 25°C) | 28 min. at 824~960MHz | 15 min. at 1710~1910MHz | WLAN/BT |
| LFB212G45CG1B982 | 2450.00 | fo±50.00 | 1.00 max. (at 25°C) | 28 min. at 824~849MHz | 17 min. at 1920~1990MHz | WLAN/BT |
| LFB212G45CG2D013 | 2450.00 | fo±50.00 | 2.50 max. (at 25°C) | 30 min. at 824~915MHz | 32 min. at 1920~1980MHz | WLAN/BT |

● LFB21(0805)_SG Series

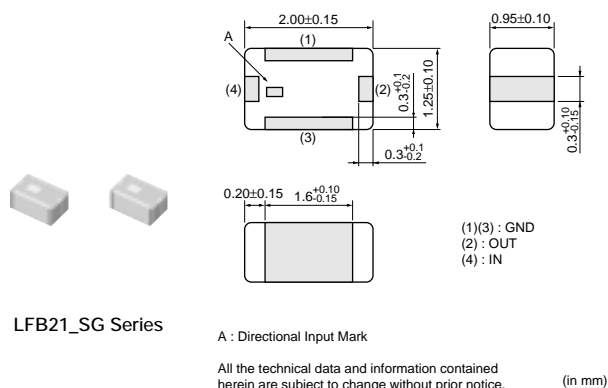

Frequency Characteristics

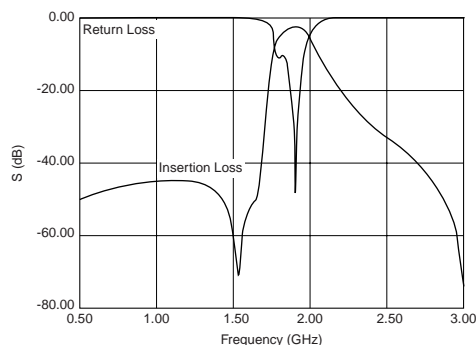

| Part Number | Nominal Center Frequency (fo) (MHz) | Bandwidth (BW) (MHz) | Insertion Loss in BW (dB) | Attenuation (Absolute Value) I) (dB) | Attenuation (Absolute Value) II) (dB) | Application |
|------------------|-------------------------------------|----------------------|---------------------------|--------------------------------------|---------------------------------------|-------------|
| LFB211G90SG8B704 | 1906.5 | fo±13.5 | 3.0 max. (at 25°C) | 20 min. at 1660.5~1686.3MHz | 11 min. at 2126.8~2152.6MHz | PHS |
| LFB212G45SG8A127 | 2450 | fo±50 | 1.5 max. (at 25°C) | 25 min. at 1200~1300MHz | 10.0 min. at 2000MHz | WLAN/BT |
| LFB212G45SG8A143 | 2450 | fo±50 | 2.7 max. (at 25°C) | 20 min. at 880~1710MHz | 30 min. at 1710~1990MHz | WLAN/BT |
| LFB212G45SG8A166 | 2450 | fo±50 | 1.4 max. (at 25°C) | 30 min. at 824~960MHz | 30 min. at 1710~1910MHz | WLAN/BT |
| LFB212G45SG8A192 | 2450 | fo±50 | 2.6 max. (at 25°C) | 40 min. at 880~960MHz | 38 min. at 1710~1990MHz | WLAN/BT |
| LFB212G49SG8B830 | 2495 | fo±195 | 2.4 max. (at 25°C) | 30 min. at 824~960MHz | 9 min. at 1710~1990MHz | WIMAX |
| LFB213G60SG8B831 | 3600 | fo±300 | 1.5 max. (at 25°C) | 32 min. at 824~960MHz | 24 min. at 1710~1990MHz | WIMAX |
| LFB215G12SG8A178 | 5125 | fo±225 | 1.5 max. (at 25°C) | 25 min. at 4200MHz | 17 min. at 2x(fo±225)MHz | WLAN/BT |
| LFB215G12SG8A183 | 5125 | fo±225 | 1.5 max. (at 25°C) | 9.0 min. at 4250MHz | 9.5 min. at 5900MHz | WLAN/BT |

Continued on the following page.

Continued from the preceding page.

| Part Number | Nominal Center Frequency (fo) (MHz) | Bandwidth (BW) (MHz) | Insertion Loss in BW (dB) | Attenuation (Absolute Value) I (dB) | Attenuation (Absolute Value) II (dB) | Application |
|------------------|-------------------------------------|----------------------|---------------------------|-------------------------------------|--------------------------------------|-------------|
| LFB215G25SG8A144 | 5250 | fo±100.0 | 1.5 max. (at 25°C) | 30 min. at 3450MHz | - | WLAN/BT |
| LFB215G37SG8A180 | 5375 | fo±475 | 1.8 max. (at 25°C) | 30.0 min. at 500~4000MHz | 35.0 min. at 3450MHz | WLAN/BT |
| LFB215G37SG8A185 | 5375 | fo±475 | 2.2 max. (at 25°C) | 40 min. at 340~1195MHz | 21 min. at 2140~3580MHz | WLAN/BT |
| LFB215G51SG8A132 | 5512 | fo±363 | 1.9 max. (at 25°C) | 30 min. at 500~4000MHz | 20 min. at 4600MHz | WLAN/BT |
| LFB215G78SG8A170 | 5787.5 | fo±62.5 | 2.2 max. (at 25°C) | 35 min. at 3275~3400MHz | 37 min. at 2x(fo±62.5)MHz | WLAN/BT |

LFB2H(1008)_CC Series

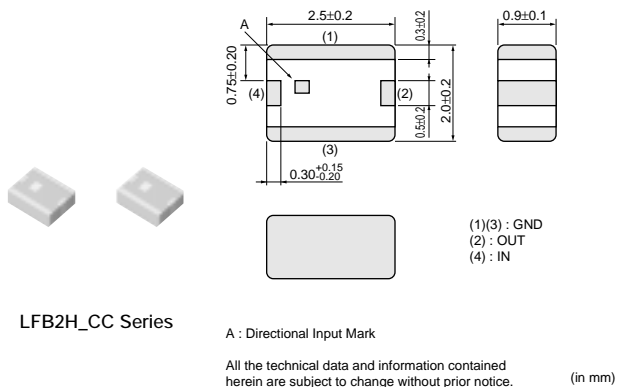

Frequency Characteristics

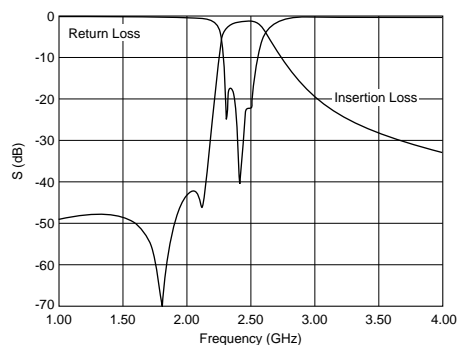

| Part Number | Nominal Center Frequency (fo) (MHz) | Bandwidth (BW) (MHz) | Insertion Loss in BW (dB) | Attenuation (Absolute Value) I (dB) | Attenuation (Absolute Value) II (dB) | Application |
|------------------|-------------------------------------|----------------------|---------------------------|-------------------------------------|--------------------------------------|-------------|
| LFB2H2G45CC1D005 | 2450.00 | fo±50.00 | 1.60 max. (at 25°C) | 45 min. at 746~960MHz | 40 min. at 1920~1990MHz | WLAN/BT |

LFB2H(1008)_CG Series



Frequency Characteristics

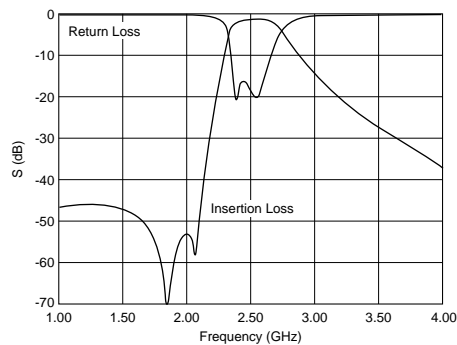

| Part Number | Nominal Center Frequency (fo) (MHz) | Bandwidth (BW) (MHz) | Insertion Loss in BW (dB) | Attenuation (Absolute Value) I (dB) | Attenuation (Absolute Value) II (dB) | Application |
|------------------|-------------------------------------|----------------------|---------------------------|-------------------------------------|--------------------------------------|-------------|
| LFB2H2G45CG1C026 | 2450.00 | fo±50.00 | 2.10 max. (at 25°C) | 43 min. at 806~849MHz | 43 min. at 1920~1990MHz | WLAN/BT |

● LFB2H(1008)_SG/LFB31(1206)_SG Series



LFB2H_SG6 Series



Frequency Characteristics



LFB2H_SG7 Series



The Characteristics of Spurious

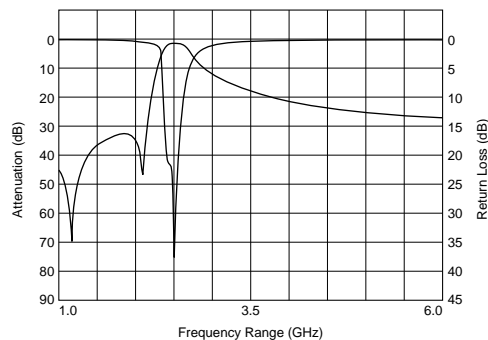

LFB31_SG1 Series



Frequency Characteristics

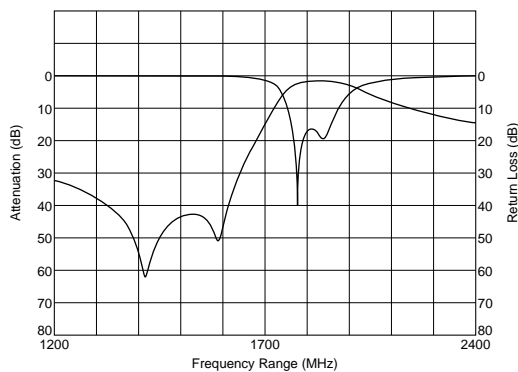

LFB31_SG2 Series



Frequency Characteristics



Continued on the following page.

△Note • This PDF catalog is downloaded from the website of Murata Manufacturing Co., Ltd. Therefore, it's specifications are subject to change or our products in it may be discontinued without advance notice. Please check with our sales representatives or product engineers before ordering.
 • This PDF catalog has only typical specifications because there is no space for detailed specifications. Therefore, please approve our product specifications or transact the approval sheet for product specifications before ordering.

Continued from the preceding page.



LFB31_SG3 Series



All the technical and Information contained herein are subject to change without prior notice.

Frequency Characteristics



LFB31_SG7 Series

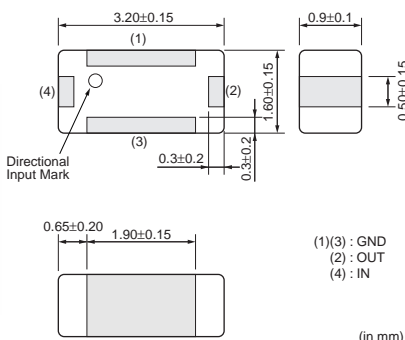

All the technical data and information contained herein are subject to change without prior notice.

Frequency Characteristics



| Part Number | Nominal Center Frequency (fo) (MHz) | Bandwidth (BW) (MHz) | Insertion Loss in BW (dB) | Attenuation (Absolute Value) I) (dB) | Attenuation (Absolute Value) II) (dB) | Application |
|------------------|-------------------------------------|----------------------|---------------------------|--------------------------------------|---------------------------------------|--------------|
| LFB2H1G90SG6A157 | 1906.5 | fo±13.5 | 1.5 max. (at 25°C) | 14 min. at 1687MHz | 6 min. at 2126MHz | PHS |
| LFB2H2G45SG7A134 | 2450 | fo±50 | 1.7 max. (at 25°C) | 25 min. at 1750MHz | 25 min. at 2100MHz | WLAN/BT |
| LFB2H2G45SG7A158 | 2450 | fo±50 | 1.2 max. (at 25°C) | 30 min. at 880~915MHz | 30 min. at 1710~1785MHz | WLAN/BT |
| LFB2H2G45SG7A159 | 2450 | fo±50 | 2.1 max. (at 25°C) | 45 min. at 880~915MHz | 48 min. at 1710~1990MHz | WLAN/BT |
| LFB2H2G45SG7B793 | 2450 | fo±50 | 3.5 max. (at 25°C) | 42 min. at 869~915MHz | 45 min. at 1710~1785MHz | WLAN/BT |
| LFB2H2G45SG7C093 | 2450 | fo±50 | 2.1 max. (at 25°C) | 45 min. at 824~915MHz | 48 min. at 1710~1990MHz | WLAN/BT |
| LFB2H2G45SGDB865 | 2450 | fo±50 | 3.4 max. (at 25°C) | 45 min. at 880~915MHz | 40 min. at 1710~1785MHz | WLAN/BT |
| LFB2H2G45SGFB914 | 2450 | fo±50 | 2.3 max. (at 25°C) | 44 min. at 824~960MHz | 40 min. at 1710~1785MHz | WLAN/BT |
| LFB2H2G54SG7B881 | 2545 | fo±145 | 2 max. (at 25°C) | 39.5 min. at 1910MHz | 39.5 min. at 1990MHz | WIMAX |
| LFB2H2G59SG7B858 | 2590 | fo±100 | 2.1 max. (at 25°C) | 40 min. at 824~915MHz | 30 min. at 2110~2170MHz | WIMAX |
| LFB2H5G78SG7A175 | 5787.5 | fo±62.5 | 2.5 max. (at 25°C) | 51.5 min. at 902~928MHz | 41 min. at 3919~4044MHz | WLAN/BT |
| LFB311G90SG1-799 | 1906.5 | fo +24.5/-13.5MHz | 2.5 max. (at 25°C) | 40 min. at 1397.05~1422.85MHz | 35 min. at 1645.5~1671.3MHz | PHS |
| LFB311G90SG2-797 | 1906.5 | fo±13.5 | 2.7 max. (at 25°C) | 40 min. at 1427~1454MHz | 35 min. at 1660~1687MHz | PHS |
| LFB311G95SG3A564 | 1950 | fo±30 | 3.5 max. (at 25°C) | 20 min. at 2110~2170MHz | 25 min. at 2490~2550MHz | UMTS (Band1) |

Continued on the following page.

Continued from the preceding page.

| Part Number | Nominal Center Frequency (fo) (MHz) | Bandwidth (BW) (MHz) | Insertion Loss in BW (dB) | Attenuation (Absolute Value) I (dB) | Attenuation (Absolute Value) II (dB) | Application |
|------------------|-------------------------------------|----------------------|---------------------------|-------------------------------------|--------------------------------------|-------------|
| LFB312G45SG2A509 | 2450 | fo±50 | 2 max. (at 25°C) | 38 min. at 902~928MHz | 15 min. at 2100~2200MHz | WLAN/BT |
| LFB312G45SG7A572 | 2450 | fo±50 | 2.5 max. (at 25°C) | 37 min. at 902~928MHz | 20 min. at 2100~2200MHz | WLAN/BT |

● LFB31_SP Series (1206)



Frequency Characteristics



| Part Number | Nominal Center Frequency (fo) (MHz) | Bandwidth (BW) (MHz) | Insertion Loss in BW (dB) | Attenuation (Absolute Value) I (dB) | Attenuation (Absolute Value) II (dB) | Application |
|------------------|-------------------------------------|----------------------|---------------------------|-------------------------------------|--------------------------------------|-------------|
| LFB311G90SP1-798 | 1906.5 | fo±13.5 | 1.0 max. (at 25°C) | 40.0 min. at 1405~1440MHz | 12.0 min. at 1649~1680MHz | PHS |
| LFB312G45SP1A502 | 2450 | fo±50 | 1.2 max. (at 25°C) | 20 min. at 902~928MHz | 35 min. at 1500~1550MHz | WLAN/BT |

for RF/Local

Chip Multilayer LC Filters (LPF)

● LFL15_TC (0402) /LFL18_TC (0603) Series



Frequency Characteristics

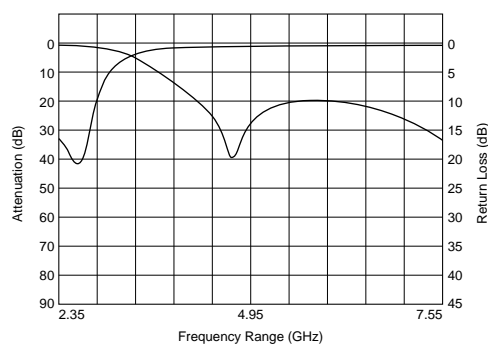

Continued on the following page.

Continued from the preceding page.



LFL18_TC1 Series

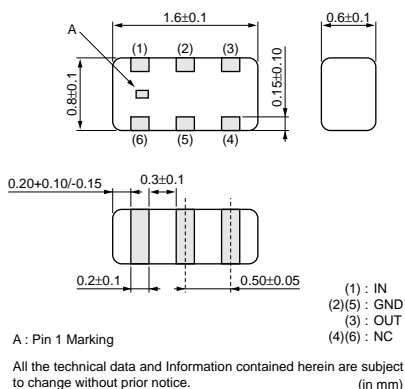

Frequency Characteristics

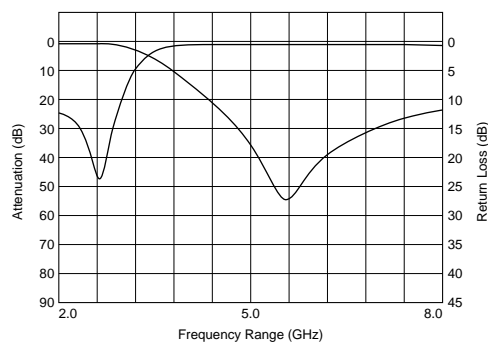

| Part Number | Nominal Center Frequency (fo) (MHz) | Bandwidth (BW) (MHz) | Insertion Loss in BW (dB) | Attenuation (Absolute Value) I) (dB) | Attenuation (Absolute Value) II) (dB) | Application |
|------------------|-------------------------------------|----------------------|---------------------------|--------------------------------------|---------------------------------------|------------------------|
| LFL15620MTC1C037 | 620 | fo±150 | 0.4 max. (at 25°C) | 28 min. at 1920~1980MHz | - | CDMA |
| LFL15869MTC1B787 | 869.5 | fo±45.5 | 0.50 max. (at 25°C) | 18 min. at 2x(fo±45.5)MHz | 17 min. at 3x(fo±45.5)MHz | GSM850/900 |
| LFL151G81TC1B786 | 1810 | fo±100 | 0.60 max. (at 25°C) | 23 min. at 3420~3570MHz | 21 min. at 3700~3820MHz | GSM1800/1900 |
| LFL151G95TC1C157 | 2017.5 | fo±20 | 0.50 max. (at 25°C) | 24 min. at 2xf1 MHz | 16 min. at 3xf1 MHz | TD-SCDMA |
| LFL152G45TC1A219 | 2450 | fo±50 | 0.45 max. (at 25°C) | 21 min. at 2x(fo±50.0)MHz | 21 min. at 3x(fo±50.0)MHz | WLAN/BT |
| LFL18620MTC2C181 | 620.00 | fo±150.00 | 0.60 max. (at 25°C) | 26 min. at 1429~1501MHz | 26 min. at 1565~1607MHz | CDMA700 |
| LFL18628MTC2C221 | 628.50 | fo±158.50 | 0.65 max. (at 25°C) | 26 min. at 1429~1501MHz | 30 min. at 1565~1607MHz | UMTS (Band12/13/14/17) |
| LFL182G45TC1A108 | 2450 | fo±50 | 0.37 max. (at 25°C) | 27 min. at 4800~5000MHz | 25 min. at 7200~7500MHz | WLAN/BT |
| LFL182G45TC1A202 | 2450 | fo±50 | 0.40 max. (at 25°C) | 27 min. at 4800~5000MHz | 30 min. at 7200~7500MHz | WLAN/BT |
| LFL182G45TC3B746 | 2450 | fo±50 | 0.60 max. (at 25°C) | 35 min. at 2x(fo±50)MHz | 30 min. at 3x(fo±50)MHz | WLAN/BT |
| LFL182G50TC1B905 | 2500 | fo±200 | 0.4 max. (at 25°C) | 21 min. at 4600~5400MHz | 22 min. at 6900~8100MHz | WIMAX |
| LFL182G54TC1B838 | 2545 | fo±145 | 0.4 max. (at 25°C) | 26 min. at 4800~5390MHz | 23 min. at 7200~8085MHz | WIMAX |
| LFL183G55TC2B908 | 3550 | fo±250 | 0.45 max. (at 25°C) | 17 min. at 6600~7600MHz | 20 min. at 9900~11400MHz | WIMAX |
| LFL183G55TC3C218 | 3550.00 | fo±250.00 | 0.55 max. (at 25°C) | 35 min. at 6600~7600MHz | 34 min. at 9900~11400MHz | WIMAX |

7 Filters for Communication Equipment

● LFL18_TD (0603) Series



LFL18_TD Series

Frequency Characteristics



| Part Number | Nominal Center Frequency (fo) (MHz) | Bandwidth (BW) (MHz) | Insertion Loss in BW (dB) | Attenuation (Absolute Value) I) (dB) | Attenuation (Absolute Value) II) (dB) | Application |
|------------------|-------------------------------------|----------------------|---------------------------|--------------------------------------|---------------------------------------|-------------|
| LFL182G45TD2C153 | 2450.00 | fo±50.00 | 0.40 max. (at 25°C) | 20 min. at 4800~5000MHz | 19 min. at 7200~7500MHz | WLAN/BT |
| LFL185G42TD1A241 | 5425.00 | fo±525.00 | 0.60 max. (at 25°C) | 25 min. at 2xfo MHz | 20 min. at 3xfo MHz | WLAN |

● LFL21_TC (0805) Series

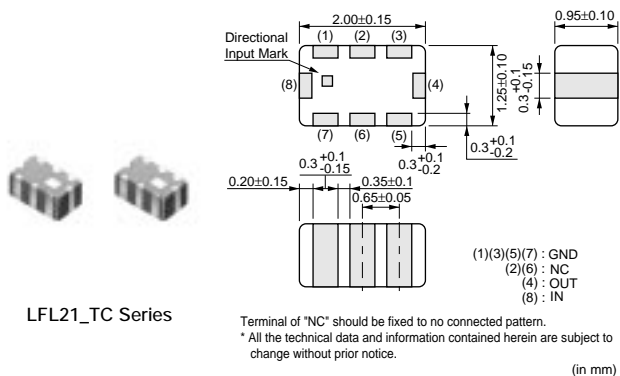

LFL21_TC Series

Frequency Characteristics

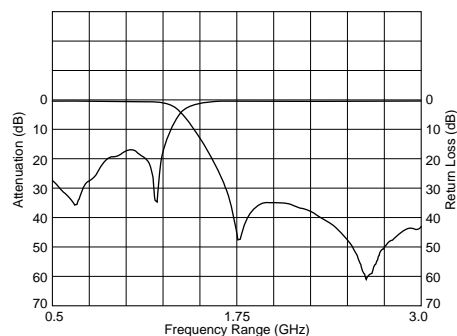

| Part Number | Nominal Center Frequency (fo) (MHz) | Bandwidth (BW) (MHz) | Insertion Loss in BW (dB) | Attenuation (Absolute Value) I) (dB) | Attenuation (Absolute Value) II) (dB) | Application |
|------------------|-------------------------------------|----------------------|---------------------------|--------------------------------------|---------------------------------------|--------------|
| LFL21902MTC1A018 | 902.5 | fo±12.5 | 0.6 max. (at 25°C) | 30 min. at 2x(fo±12.5)MHz | 30 min. at 3x(fo±12.5)MHz | GSM |
| LFL211G90TC1A008 | 1907.5 | fo±12.5 | 0.47 max. (at 25°C) | 30 min. at 2x(fo±12.5)MHz | 25 min. at 3x(fo±12.5)MHz | PHS |
| LFL211G92TC1A060 | 1920 | fo±70 | 0.6 max. (at 25°C) | 24 min. at 3335~3700MHz | 30 min. at 3700~3820MHz | UMTS (Band1) |
| LFL212G45TC1A007 | 2450 | fo±50 | 0.50 max. (at 25°C) | 27 min. at 2x(fo±50.0)MHz | 30 min. at 3x(fo±50.0)MHz | WLAN/BT |
| LFL215G25TC1A156 | 5250 | fo±100.0 | 0.70 max. (at 25°C) | 24 min. at 2x(fo±100)MHz | 19 min. at 3x(fo±100)MHz | WLAN/BT |
| LFL215G37TC1A210 | 5375 | fo±475 | 0.70 max. (at 25°C) | 30 min. at 2x(fo±475)MHz | 20 min. at 3x(fo±475)MHz | WLAN/BT |
| LFL215G51TC1A149 | 5512 | fo±363 | 0.70 max. (at 25°C) | 30 min. at 2x(fo±363)MHz | 20 min. at 3x(fo±363)MHz | WLAN/BT |
| LFL215G78TC1A155 | 5787.5 | fo±62.5 | 0.70 max. (at 25°C) | 30 min. at 2x(fo±62.5)MHz | 20 min. at 3x(fo±62.5)MHz | WLAN/BT |

△Note • This PDF catalog is downloaded from the website of Murata Manufacturing co., Ltd. Therefore, it's specifications are subject to change or our products in it may be discontinued without advance notice. Please check with our sales representatives or product engineers before ordering.
 • This PDF catalog has only typical specifications because there is no space for detailed specifications. Therefore, please approve our product specifications or transact the approval sheet for product specifications before ordering.

for RF/Local

Chip Multilayer LC Filters (Balanced Filters)



LFB21_BA Series

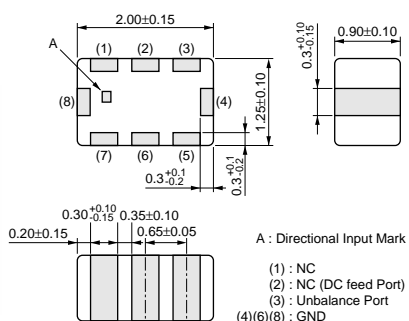

A : Directional Input Mark

- (1) : NC
- (2) : NC (DC feed Port)
- (3) : Unbalance Port
- (4)(6)(8) : GND
- (5)(7) : Balance Port

• All the technical data and information contained herein are subject to change without prior notice.
(in mm)

| Part Number | Nominal Center Frequency (fo) (MHz) | Bandwidth (BW) (MHz) | Insertion Loss in BW (dB) | Balance Impedance (Differential) (Nom.) (ohm) | Unbalance Impedance (Nom.) (ohm) | Application |
|------------------|-------------------------------------|----------------------|---------------------------|--|----------------------------------|-------------|
| LFB212G44BB1C141 | 2441 | fo±39 | 3.00 max. (at 25°C) | Conjugate match to CSR BC5-MM | 50 | WLAN/BT |
| LFB212G44BF5D107 | 2441 | fo±39 | 3.30 max. (at 25°C) | Conjugate match to ST Micro STLC2584 | 50 | WLAN/BT |
| LFB212G45BA1A220 | 2450.00 | fo±50.00 | 3.5 max. (at 25°C) | 34.2 -j95.0ohm (Differential) Source Impedance | 50 | WLAN/BT |
| LFB212G45BA1A234 | 2450.00 | fo±50.00 | 3.5 max. (at 25°C) | 50 | 50 | WLAN/BT |
| LFB212G45BA1B759 | 2450.00 | fo±50.00 | 3.5 max. (at 25°C) | 100 | 50 | WLAN/BT |
| LFB212G45BA1B763 | 2450.00 | fo±50.00 | 3.5 max. (at 25°C) | 50 +j50ohm (Differential) Source Impedance | 50 | WLAN/BT |
| LFB212G45BA1C057 | 2450 | fo±50 | 2.8 max. (at 25°C) | Conjugate match to CSR BC4-ROM | 50 | WLAN/BT |
| LFB212G45BA1C155 | 2450 | fo±50 | 2.80 max. (at 25°C) | Conjugate match to CSR BC4-ROM | 50 | WLAN/BT |
| LFB212G45BA4D007 | 2450 | fo±50 | 3.30 max. (at 25°C) | Conjugate match to TI BRF6300/6350 | 50 | WLAN/BT |
| LFB212G45BAAD023 | 2450 | fo±50 | 3.10 max. (at 25°C) | Conjugate match to Mediatek MT6611 | 50 | WLAN/BT |
| LFB212G45BAAD071 | 2450 | fo±50 | 3.50 max. (at 25°C) | Conjugate match to CSR BC6-ROM | 50 | WLAN/BT |
| LFB212G45BAAD084 | 2450.00 | fo±50.00 | 2.8 max. (at 25°C) | Conjugate match to MTK MT6611 | 50 | WLAN/BT |
| LFB212G45BB1D126 | 2450.00 | fo±50.00 | 2.8 max. (at 25°C) | Conjugate match to MTK MT6612/6616 | 50 | WLAN/BT |
| LFB213G55BA1B974 | 3550 | fo±250 | 3.2 max. (at 25°C) | 100 | 50 | WIMAX |
| LFB215G37BA1A233 | 5375.00 | fo±475.00 | 2.8 max. (at 25°C) | 100 | 50 | WLAN/BT |
| LFB2H2G44BB5B754 | 2441.75 | fo±41.75 | 3.3 max. (at 25°C) | 120 | 50 | WLAN/BT |
| LFB2H2G45BB1A221 | 2450 | fo±50 | 3.0 max. (at 25°C) | 75 | 50 | WLAN/BT |
| LFB2H2G45BB1A243 | 2450 | fo±50 | 3.0 max. (at 25°C) | 100 | 50 | WLAN/BT |
| LFB2H2G60BB1B973 | 2600 | fo±100 | 3.3 max. (at 25°C) | 100 | 50 | WIMAX |
| LFB2H2G60BB1C106 | 2600 | fo±100 | 3.3 max. (at 25°C) | 50 | 50 | WIMAX |