

for RF/Local

Chip Multilayer LC Filters (BPF)

● LFB15(0402)_CB Series



Frequency Characteristics

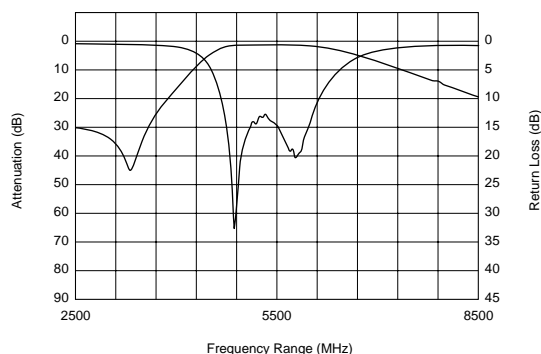

Part Number	Nominal Center Frequency (fo) (MHz)	Bandwidth (BW) (MHz)	Insertion Loss in BW (dB)	Attenuation (Absolute Value I) (dB)	Attenuation (Absolute Value II) (dB)	Application
LFB155G37CB1C032	5375	fo±475	1.5 max. (at 25°C)	10 min. at 3800MHz	5 min. at 7500MHz	WLAN/BT
LFB155G50CB1B948	5500	fo±350	1.1 max. (at 25°C)	9.5 min. at 4000MHz	4.5 min. at 7500MHz	WLAN/BT

● LFB18(0603)_SG Series



Frequency Characteristics



Part Number	Nominal Center Frequency (fo) (MHz)	Bandwidth (BW) (MHz)	Insertion Loss in BW (dB)	Attenuation (Absolute Value I) (dB)	Attenuation (Absolute Value II) (dB)	Application
LFB182G45SG9A213	2450	fo±50	2.2 max. (at 25°C)	24 min. at 880~960MHz	20 min. at 1710~1990MHz	WLAN/BT
LFB182G45SG9A246	2450	fo±50	2.2 max. (at 25°C)	24.5 min. at 880~960MHz	12.5 min. at 1710~1990MHz	WLAN/BT
LFB182G45SG9A272	2450	fo±50	1.8 max. (at 25°C)	25 min. at 880~1000MHz	22.5 min. at 1200~1300MHz	WLAN/BT
LFB182G60SGHB972	2600	fo±100.0	1.9 max. (at 25°C)	29.5 min. at 806~849MHz	25 min. at 1850~1910MHz	WIMAX
LFB182G60SGHC149	2600	fo±100.0	2.2 max. (at 25°C)	29.5 min. at 806~849MHz	30 min. at 1850~1910MHz	WIMAX
LFB183G60SGJC019	3500	fo±200	1.8 max. (at 25°C)	25.5 min. at 806~849MHz	21.5 min. at 1850~1910MHz	WIMAX
LFB185G78SGAB713	5787.5	fo±62.5	2.2 max. (at 25°C)	16.5 min. at 4800MHz	23.5 min. at 11450~11700MHz	WLAN/BT

● LFB21(0805)_CG Series



Frequency Characteristics



LFB21_CG Series

Part Number	Nominal Center Frequency (fo) (MHz)	Bandwidth (BW) (MHz)	Insertion Loss in BW (dB)	Attenuation (Absolute Value) I) (dB)	Attenuation (Absolute Value) II) (dB)	Application
LFB212G45CG1C187	2450.00	fo±50.00	0.90 max. (at 25°C)	28 min. at 824~960MHz	15 min. at 1710~1910MHz	WLAN/BT
LFB212G45CG1B982	2450.00	fo±50.00	1.00 max. (at 25°C)	28 min. at 824~849MHz	17 min. at 1920~1990MHz	WLAN/BT
LFB212G45CG2D013	2450.00	fo±50.00	2.50 max. (at 25°C)	30 min. at 824~915MHz	32 min. at 1920~1980MHz	WLAN/BT

● LFB21(0805)_SG Series



Frequency Characteristics



LFB21_SG Series

A : Directional Input Mark
 All the technical data and information contained herein are subject to change without prior notice.

Part Number	Nominal Center Frequency (fo) (MHz)	Bandwidth (BW) (MHz)	Insertion Loss in BW (dB)	Attenuation (Absolute Value) I) (dB)	Attenuation (Absolute Value) II) (dB)	Application
LFB211G90SG8B704	1906.5	fo±13.5	3.0 max. (at 25°C)	20 min. at 1660.5~1686.3MHz	11 min. at 2126.8~2152.6MHz	PHS
LFB212G45SG8A127	2450	fo±50	1.5 max. (at 25°C)	25 min. at 1200~1300MHz	10.0 min. at 2000MHz	WLAN/BT
LFB212G45SG8A143	2450	fo±50	2.7 max. (at 25°C)	20 min. at 880~1710MHz	30 min. at 1710~1990MHz	WLAN/BT
LFB212G45SG8A166	2450	fo±50	1.4 max. (at 25°C)	30 min. at 824~960MHz	30 min. at 1710~1910MHz	WLAN/BT
LFB212G45SG8A192	2450	fo±50	2.6 max. (at 25°C)	40 min. at 880~960MHz	38 min. at 1710~1990MHz	WLAN/BT
LFB212G49SG8B830	2495	fo±195	2.4 max. (at 25°C)	30 min. at 824~960MHz	9 min. at 1710~1990MHz	WIMAX
LFB213G60SG8B831	3600	fo±300	1.5 max. (at 25°C)	32 min. at 824~960MHz	24 min. at 1710~1990MHz	WIMAX
LFB215G12SG8A178	5125	fo±225	1.5 max. (at 25°C)	25 min. at 4200MHz	17 min. at 2x(fo±225)MHz	WLAN/BT
LFB215G12SG8A183	5125	fo±225	1.5 max. (at 25°C)	9.0 min. at 4250MHz	9.5 min. at 5900MHz	WLAN/BT

Continued on the following page.

△Note • This PDF catalog is downloaded from the website of Murata Manufacturing co., Ltd. Therefore, it's specifications are subject to change or our products in it may be discontinued without advance notice. Please check with our sales representatives or product engineers before ordering.
 • This PDF catalog has only typical specifications because there is no space for detailed specifications. Therefore, please approve our product specifications or transact the approval sheet for product specifications before ordering.

Continued from the preceding page.

Part Number	Nominal Center Frequency (fo) (MHz)	Bandwidth (BW) (MHz)	Insertion Loss in BW (dB)	Attenuation (Absolute Value) I (dB)	Attenuation (Absolute Value) II (dB)	Application
LFB215G25SG8A144	5250	fo±100.0	1.5 max. (at 25°C)	30 min. at 3450MHz	-	WLAN/BT
LFB215G37SG8A180	5375	fo±475	1.8 max. (at 25°C)	30.0 min. at 500~4000MHz	35.0 min. at 3450MHz	WLAN/BT
LFB215G37SG8A185	5375	fo±475	2.2 max. (at 25°C)	40 min. at 340~1195MHz	21 min. at 2140~3580MHz	WLAN/BT
LFB215G51SG8A132	5512	fo±363	1.9 max. (at 25°C)	30 min. at 500~4000MHz	20 min. at 4600MHz	WLAN/BT
LFB215G78SG8A170	5787.5	fo±62.5	2.2 max. (at 25°C)	35 min. at 3275~3400MHz	37 min. at 2x(fo±62.5)MHz	WLAN/BT

LFB2H(1008)_CC Series



Frequency Characteristics



Part Number	Nominal Center Frequency (fo) (MHz)	Bandwidth (BW) (MHz)	Insertion Loss in BW (dB)	Attenuation (Absolute Value) I (dB)	Attenuation (Absolute Value) II (dB)	Application
LFB2H2G45CC1D005	2450.00	fo±50.00	1.60 max. (at 25°C)	45 min. at 746~960MHz	40 min. at 1920~1990MHz	WLAN/BT

LFB2H(1008)_CG Series

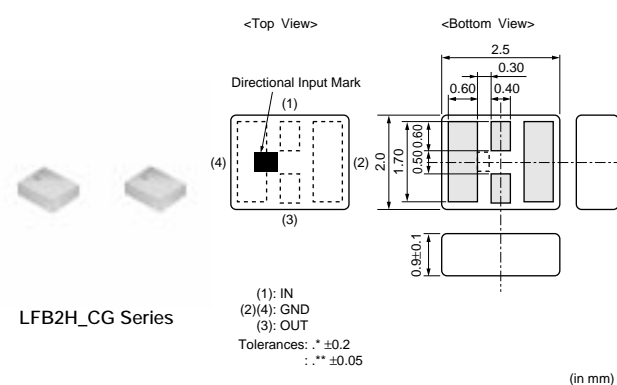

Frequency Characteristics

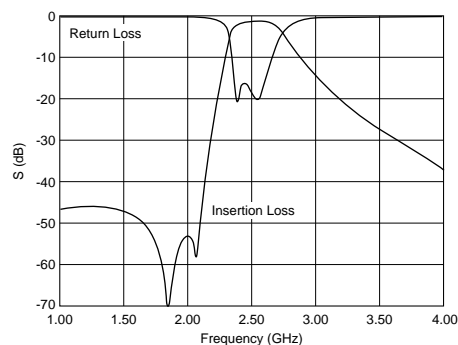

Part Number	Nominal Center Frequency (fo) (MHz)	Bandwidth (BW) (MHz)	Insertion Loss in BW (dB)	Attenuation (Absolute Value) I (dB)	Attenuation (Absolute Value) II (dB)	Application
LFB2H2G45CG1C026	2450.00	fo±50.00	2.10 max. (at 25°C)	43 min. at 806~849MHz	43 min. at 1920~1990MHz	WLAN/BT

● LFB2H(1008)_SG/LFB31(1206)_SG Series



LFB2H_SG6 Series

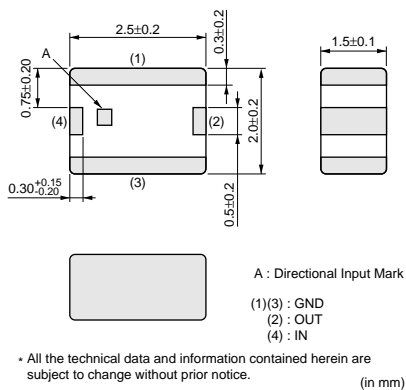

Frequency Characteristics



LFB2H_SG7 Series

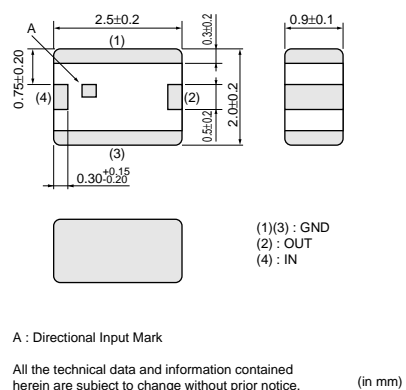

The Characteristics of Spurious



LFB31_SG1 Series

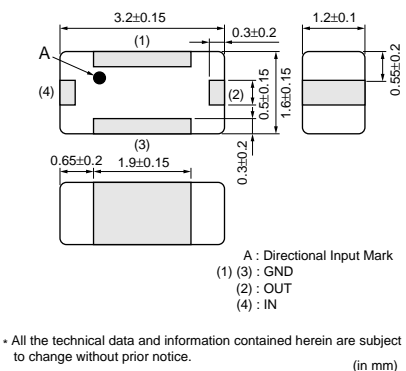

Frequency Characteristics



LFB31_SG2 Series

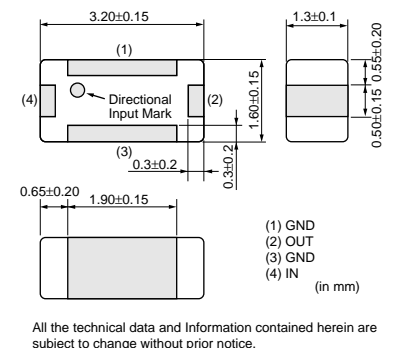

Frequency Characteristics



Continued on the following page.

△Note • This PDF catalog is downloaded from the website of Murata Manufacturing co., Ltd. Therefore, it's specifications are subject to change or our products in it may be discontinued without advance notice. Please check with our sales representatives or product engineers before ordering.
 • This PDF catalog has only typical specifications because there is no space for detailed specifications. Therefore, please approve our product specifications or transact the approval sheet for product specifications before ordering.

Continued from the preceding page.



LFB31_SG3 Series



All the technical and Information contained herein are subject to change without prior notice.

Frequency Characteristics



LFB31_SG7 Series



All the technical data and information contained herein are subject to change without prior notice.

Frequency Characteristics



Part Number	Nominal Center Frequency (fo) (MHz)	Bandwidth (BW) (MHz)	Insertion Loss in BW (dB)	Attenuation (Absolute Value) I) (dB)	Attenuation (Absolute Value) II) (dB)	Application
LFB2H1G90SG6A157	1906.5	fo±13.5	1.5 max. (at 25°C)	14 min. at 1687MHz	6 min. at 2126MHz	PHS
LFB2H2G45SG7A134	2450	fo±50	1.7 max. (at 25°C)	25 min. at 1750MHz	25 min. at 2100MHz	WLAN/BT
LFB2H2G45SG7A158	2450	fo±50	1.2 max. (at 25°C)	30 min. at 880~915MHz	30 min. at 1710~1785MHz	WLAN/BT
LFB2H2G45SG7A159	2450	fo±50	2.1 max. (at 25°C)	45 min. at 880~915MHz	48 min. at 1710~1990MHz	WLAN/BT
LFB2H2G45SG7B793	2450	fo±50	3.5 max. (at 25°C)	42 min. at 869~915MHz	45 min. at 1710~1785MHz	WLAN/BT
LFB2H2G45SG7C093	2450	fo±50	2.1 max. (at 25°C)	45 min. at 824~915MHz	48 min. at 1710~1990MHz	WLAN/BT
LFB2H2G45SGDB865	2450	fo±50	3.4 max. (at 25°C)	45 min. at 880~915MHz	40 min. at 1710~1785MHz	WLAN/BT
LFB2H2G45SGFB914	2450	fo±50	2.3 max. (at 25°C)	44 min. at 824~960MHz	40 min. at 1710~1785MHz	WLAN/BT
LFB2H2G54SG7B881	2545	fo±145	2 max. (at 25°C)	39.5 min. at 1910MHz	39.5 min. at 1990MHz	WIMAX
LFB2H2G59SG7B858	2590	fo±100	2.1 max. (at 25°C)	40 min. at 824~915MHz	30 min. at 2110~2170MHz	WIMAX
LFB2H5G78SG7A175	5787.5	fo±62.5	2.5 max. (at 25°C)	51.5 min. at 902~928MHz	41 min. at 3919~4044MHz	WLAN/BT
LFB311G90SG1-799	1906.5	fo +24.5/-13.5MHz	2.5 max. (at 25°C)	40 min. at 1397.05~1422.85MHz	35 min. at 1645.5~1671.3MHz	PHS
LFB311G90SG2-797	1906.5	fo±13.5	2.7 max. (at 25°C)	40 min. at 1427~1454MHz	35 min. at 1660~1687MHz	PHS
LFB311G95SG3A564	1950	fo±30	3.5 max. (at 25°C)	20 min. at 2110~2170MHz	25 min. at 2490~2550MHz	UMTS (Band1)

Continued on the following page.

Continued from the preceding page.

Part Number	Nominal Center Frequency (fo) (MHz)	Bandwidth (BW) (MHz)	Insertion Loss in BW (dB)	Attenuation (Absolute Value) I (dB)	Attenuation (Absolute Value) II (dB)	Application
LFB312G45SG2A509	2450	fo±50	2 max. (at 25°C)	38 min. at 902~928MHz	15 min. at 2100~2200MHz	WLAN/BT
LFB312G45SG7A572	2450	fo±50	2.5 max. (at 25°C)	37 min. at 902~928MHz	20 min. at 2100~2200MHz	WLAN/BT

● LFB31_SP Series (1206)

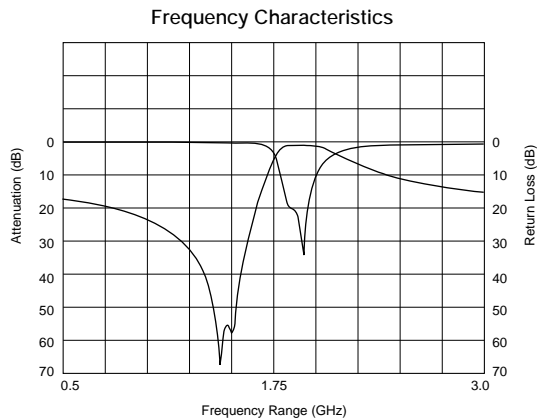

Part Number	Nominal Center Frequency (fo) (MHz)	Bandwidth (BW) (MHz)	Insertion Loss in BW (dB)	Attenuation (Absolute Value) I (dB)	Attenuation (Absolute Value) II (dB)	Application
LFB311G90SP1-798	1906.5	fo±13.5	1.0 max. (at 25°C)	40.0 min. at 1405~1440MHz	12.0 min. at 1649~1680MHz	PHS
LFB312G45SP1A502	2450	fo±50	1.2 max. (at 25°C)	20 min. at 902~928MHz	35 min. at 1500~1550MHz	WLAN/BT

for RF/Local

Chip Multilayer LC Filters (LPF)

● LFL15_TC (0402) /LFL18_TC (0603) Series

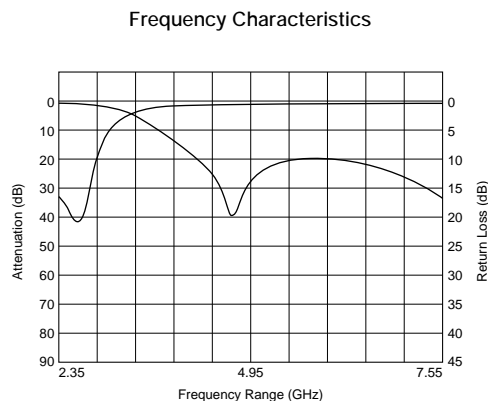
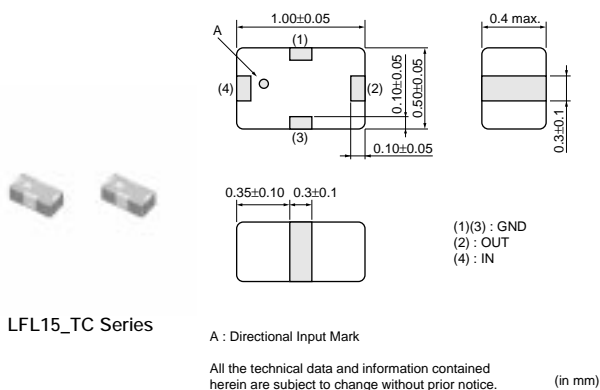

Continued on the following page.

Continued from the preceding page.



LFL18_TC1 Series



Frequency Characteristics



Part Number	Nominal Center Frequency (fo) (MHz)	Bandwidth (BW) (MHz)	Insertion Loss in BW (dB)	Attenuation (Absolute Value) I) (dB)	Attenuation (Absolute Value) II) (dB)	Application
LFL15620MTC1C037	620	fo±150	0.4 max. (at 25°C)	28 min. at 1920~1980MHz	-	CDMA
LFL15869MTC1B787	869.5	fo±45.5	0.50 max. (at 25°C)	18 min. at 2x(fo±45.5)MHz	17 min. at 3x(fo±45.5)MHz	GSM850/900
LFL151G81TC1B786	1810	fo±100	0.60 max. (at 25°C)	23 min. at 3420~3570MHz	21 min. at 3700~3820MHz	GSM1800/1900
LFL151G95TC1C157	2017.5	fo±20	0.50 max. (at 25°C)	24 min. at 2xf1 MHz	16 min. at 3xf1 MHz	TD-SCDMA
LFL152G45TC1A219	2450	fo±50	0.45 max. (at 25°C)	21 min. at 2x(fo±50.0)MHz	21 min. at 3x(fo±50.0)MHz	WLAN/BT
LFL18620MTC2C181	620.00	fo±150.00	0.60 max. (at 25°C)	26 min. at 1429~1501MHz	26 min. at 1565~1607MHz	CDMA700
LFL18628MTC2C221	628.50	fo±158.50	0.65 max. (at 25°C)	26 min. at 1429~1501MHz	30 min. at 1565~1607MHz	UMTS (Band12/13/14/17)
LFL182G45TC1A108	2450	fo±50	0.37 max. (at 25°C)	27 min. at 4800~5000MHz	25 min. at 7200~7500MHz	WLAN/BT
LFL182G45TC1A202	2450	fo±50	0.40 max. (at 25°C)	27 min. at 4800~5000MHz	30 min. at 7200~7500MHz	WLAN/BT
LFL182G45TC3B746	2450	fo±50	0.60 max. (at 25°C)	35 min. at 2x(fo±50)MHz	30 min. at 3x(fo±50)MHz	WLAN/BT
LFL182G50TC1B905	2500	fo±200	0.4 max. (at 25°C)	21 min. at 4600~5400MHz	22 min. at 6900~8100MHz	WIMAX
LFL182G54TC1B838	2545	fo±145	0.4 max. (at 25°C)	26 min. at 4800~5390MHz	23 min. at 7200~8085MHz	WIMAX
LFL183G55TC2B908	3550	fo±250	0.45 max. (at 25°C)	17 min. at 6600~7600MHz	20 min. at 9900~11400MHz	WIMAX
LFL183G55TC3C218	3550.00	fo±250.00	0.55 max. (at 25°C)	35 min. at 6600~7600MHz	34 min. at 9900~11400MHz	WIMAX

7 Filters for Communication Equipment

● LFL18_TD (0603) Series



LFL18_TD Series



Frequency Characteristics



Part Number	Nominal Center Frequency (fo) (MHz)	Bandwidth (BW) (MHz)	Insertion Loss in BW (dB)	Attenuation (Absolute Value) I) (dB)	Attenuation (Absolute Value) II) (dB)	Application
LFL182G45TD2C153	2450.00	fo±50.00	0.40 max. (at 25°C)	20 min. at 4800~5000MHz	19 min. at 7200~7500MHz	WLAN/BT
LFL185G42TD1A241	5425.00	fo±525.00	0.60 max. (at 25°C)	25 min. at 2xfo MHz	20 min. at 3xfo MHz	WLAN

● LFL21_TC (0805) Series



LFL21_TC Series

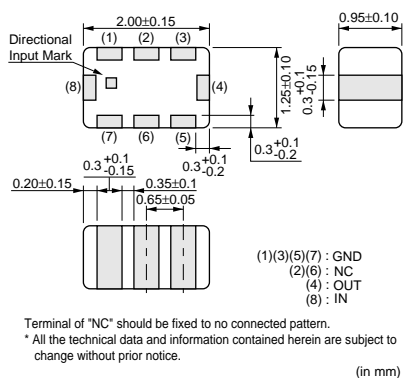

Frequency Characteristics



Part Number	Nominal Center Frequency (fo) (MHz)	Bandwidth (BW) (MHz)	Insertion Loss in BW (dB)	Attenuation (Absolute Value) I) (dB)	Attenuation (Absolute Value) II) (dB)	Application
LFL21902MTC1A018	902.5	fo±12.5	0.6 max. (at 25°C)	30 min. at 2x(fo±12.5)MHz	30 min. at 3x(fo±12.5)MHz	GSM
LFL211G90TC1A008	1907.5	fo±12.5	0.47 max. (at 25°C)	30 min. at 2x(fo±12.5)MHz	25 min. at 3x(fo±12.5)MHz	PHS
LFL211G92TC1A060	1920	fo±70	0.6 max. (at 25°C)	24 min. at 3335~3700MHz	30 min. at 3700~3820MHz	UMTS (Band1)
LFL212G45TC1A007	2450	fo±50	0.50 max. (at 25°C)	27 min. at 2x(fo±50.0)MHz	30 min. at 3x(fo±50.0)MHz	WLAN/BT
LFL215G25TC1A156	5250	fo±100.0	0.70 max. (at 25°C)	24 min. at 2x(fo±100)MHz	19 min. at 3x(fo±100)MHz	WLAN/BT
LFL215G37TC1A210	5375	fo±475	0.70 max. (at 25°C)	30 min. at 2x(fo±475)MHz	20 min. at 3x(fo±475)MHz	WLAN/BT
LFL215G51TC1A149	5512	fo±363	0.70 max. (at 25°C)	30 min. at 2x(fo±363)MHz	20 min. at 3x(fo±363)MHz	WLAN/BT
LFL215G78TC1A155	5787.5	fo±62.5	0.70 max. (at 25°C)	30 min. at 2x(fo±62.5)MHz	20 min. at 3x(fo±62.5)MHz	WLAN/BT

△Note • This PDF catalog is downloaded from the website of Murata Manufacturing Co., Ltd. Therefore, it's specifications are subject to change or our products in it may be discontinued without advance notice. Please check with our sales representatives or product engineers before ordering.
 • This PDF catalog has only typical specifications because there is no space for detailed specifications. Therefore, please approve our product specifications or transact the approval sheet for product specifications before ordering.

for RF/Local

Chip Multilayer LC Filters (Balanced Filters)

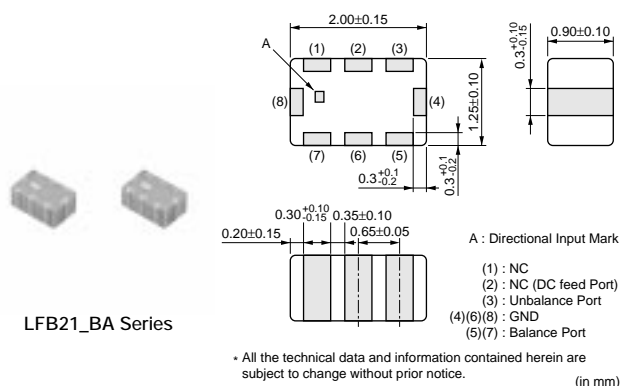

LFB21_BA Series

Part Number	Nominal Center Frequency (fo) (MHz)	Bandwidth (BW) (MHz)	Insertion Loss in BW (dB)	Balance Impedance (Differential) (Nom.) (ohm)	Unbalance Impedance (Nom.) (ohm)	Application
LFB212G44BB1C141	2441	fo±39	3.00 max. (at 25°C)	Conjugate match to CSR BC5-MM	50	WLAN/BT
LFB212G44BF5D107	2441	fo±39	3.30 max. (at 25°C)	Conjugate match to ST Micro STLC2584	50	WLAN/BT
LFB212G45BA1A220	2450.00	fo±50.00	3.5 max. (at 25°C)	34.2 -j95.0ohm (Differential) Source Impedance	50	WLAN/BT
LFB212G45BA1A234	2450.00	fo±50.00	3.5 max. (at 25°C)	50	50	WLAN/BT
LFB212G45BA1B759	2450.00	fo±50.00	3.5 max. (at 25°C)	100	50	WLAN/BT
LFB212G45BA1B763	2450.00	fo±50.00	3.5 max. (at 25°C)	50 +j50ohm (Differential) Source Impedance	50	WLAN/BT
LFB212G45BA1C057	2450	fo±50	2.8 max. (at 25°C)	Conjugate match to CSR BC4-ROM	50	WLAN/BT
LFB212G45BA1C155	2450	fo±50	2.80 max. (at 25°C)	Conjugate match to CSR BC4-ROM	50	WLAN/BT
LFB212G45BA4D007	2450	fo±50	3.30 max. (at 25°C)	Conjugate match to TI BRF6300/6350	50	WLAN/BT
LFB212G45BAAD023	2450	fo±50	3.10 max. (at 25°C)	Conjugate match to Mediatek MT6611	50	WLAN/BT
LFB212G45BAAD071	2450	fo±50	3.50 max. (at 25°C)	Conjugate match to CSR BC6-ROM	50	WLAN/BT
LFB212G45BAAD084	2450.00	fo±50.00	2.8 max. (at 25°C)	Conjugate match to MTK MT6611	50	WLAN/BT
LFB212G45BB1D126	2450.00	fo±50.00	2.8 max. (at 25°C)	Conjugate match to MTK MT6612/6616	50	WLAN/BT
LFB213G55BA1B974	3550	fo±250	3.2 max. (at 25°C)	100	50	WIMAX
LFB215G37BA1A233	5375.00	fo±475.00	2.8 max. (at 25°C)	100	50	WLAN/BT
LFB2H2G44BB5B754	2441.75	fo±41.75	3.3 max. (at 25°C)	120	50	WLAN/BT
LFB2H2G45BB1A221	2450	fo±50	3.0 max. (at 25°C)	75	50	WLAN/BT
LFB2H2G45BB1A243	2450	fo±50	3.0 max. (at 25°C)	100	50	WLAN/BT
LFB2H2G60BB1B973	2600	fo±100	3.3 max. (at 25°C)	100	50	WIMAX
LFB2H2G60BB1C106	2600	fo±100	3.3 max. (at 25°C)	50	50	WIMAX