

Description: GNSS-DUAL WIFI-DSRC ANT

Series: CERAMIC CHIP

PART NUMBER: W3095

Features:

- 3 in 1 solution on a ceramic chip with two separate feeds.
- Need smaller antenna space on PCB to integrate GPS/GLONASS, Dual WiFi and DSRC bands
- Compact Size (L x W x H) 10 x 3.2 x 1.5mm.
- Fully SMD compatible

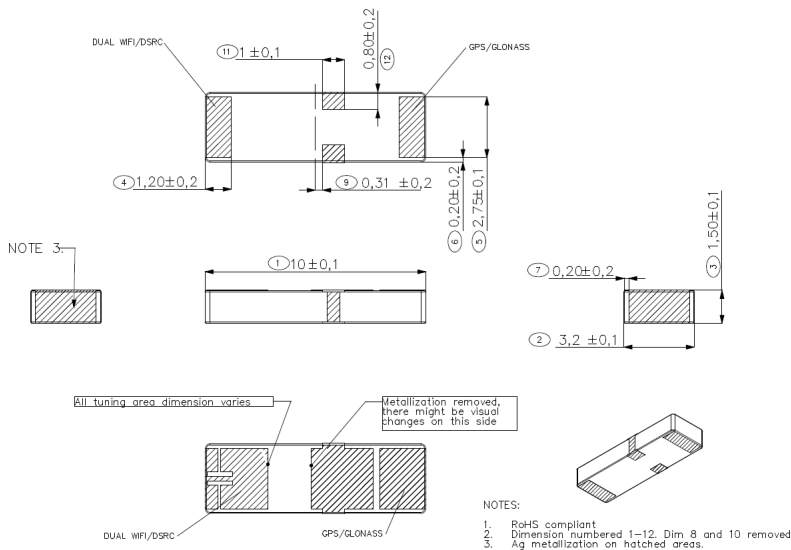
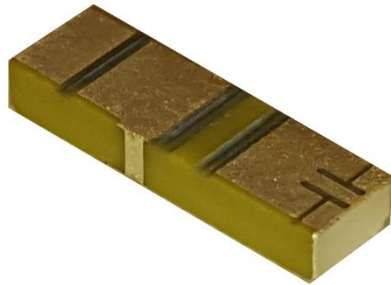

Applications:

- GPS / GLONASS (1575-1610MHz)
- IEEE 802.11 a/b/g/n compliant 2.4 and 5GHz. (2400-2485/ 4900-5850MHz)
- DSRC (5850-5925MHz)
- Mobile navigation device

All dimensions are in mm / inches

Issue: 1804

In the effort to improve our products, we reserve the right to make changes judged to be necessary.

CONFIDENTIAL AND PROPRIETARY INFORMATION

This document contains confidential and proprietary information of Pulse Electronics, Inc. (Pulse) and is protected by copyright, trade secret and other state and federal laws. Its receipt or possession does not convey any rights to reproduce, disclose its contents, or to manufacture, use or sell anything it may describe. Reproduction, disclosure or use without specific written authorization of Pulse is strictly forbidden.

For more information:

Pulse Worldwide Headquarters  
15255 Innovation Drive #100  
San Diego, CA 92128  
USA  
Tel: 1-858-674-8100

Pulse/Larsen Antennas  
18110 SE 34<sup>th</sup> St Bldg 2 Suite 250  
Vancouver, WA 98683  
USA  
Tel: 1-360-944-7551

Europe Headquarters  
Pulse GmbH & Do, KG  
Zeppelinstrasse 15  
Herrenberg, Germany  
Tel: 49 7032 7806 0

Pulse (Suzhou) Wireless Products Co, Inc.  
99 Huo Ju Road(#29 Bldg,4<sup>th</sup> Phase  
Suzhou New District  
Jiangsu Province, Suzhou 215009 PR China  
Tel: 86 512 6807 9998



**Description:** GNSS-DUAL WIFI-DSRC ANT**Series:** CERAMIC CHIP**PART NUMBER:** W3095**ELECTRICAL SPECIFICATIONS**

Frequency, Port 1	1.575-1.610 GHz
Frequency, Port 2	2.4-2.485/ 4.9-5.925 GHz
Normal Impedance	50 Ohm
VSWR, Port 1	<2.5:1
VSWR, Port 2	<2:1 at low band <2.8:1 at high band
Efficiency (Typ.), Port 1	60 %
Efficiency (Typ.), Port 2	80/ 50 %
Peak Gain, Port 1	1.5 dBi
Peak Gain, Port 2	2.5/ 3.5 dBi
Isolation (Min.) at 1.575-1.610 GHz	22 dB
Isolation (Min.) at 2.4-2.485 GHz	20 dB
Isolation (Min.) at 4.9-5.925 GHz	22 dB
Polarization	Linear
Interface	SMD Mount

Issue: 1804

In the effort to improve our products, we reserve the right to make changes judged to be necessary.

CONFIDENTIAL AND PROPRIETARY INFORMATION

This document contains confidential and proprietary information of Pulse Electronics, Inc. (Pulse) and is protected by copyright, trade secret and other state and federal laws. Its receipt or possession does not convey any rights to reproduce, disclose its contents, or to manufacture, use or sell anything it may describe. Reproduction, disclosure or use without specific written authorization of Pulse is strictly forbidden.

**Description:** GNSS-DUAL WIFI-DSRC ANT

**Series:** CERAMIC CHIP

**PART NUMBER:** W3095

### MECHANICAL SPECIFICATIONS

Block material	Dielectric ceramic
Plating material	Ag
Weight	0.24 g
RoHS Compliant Product	
Tape and reel packing	
Lead free materials	
Lead free soldering compatible	

### ENVIRONMENTAL SPECIFICATIONS

Operating temperature	-30 to +80° C
-----------------------	---------------

**Description: GNSS-DUAL WIFI-DSRC ANT**

**Series: CERAMIC CHIP**

**PART NUMBER: W3095**

**MECHANICAL DRAWING**

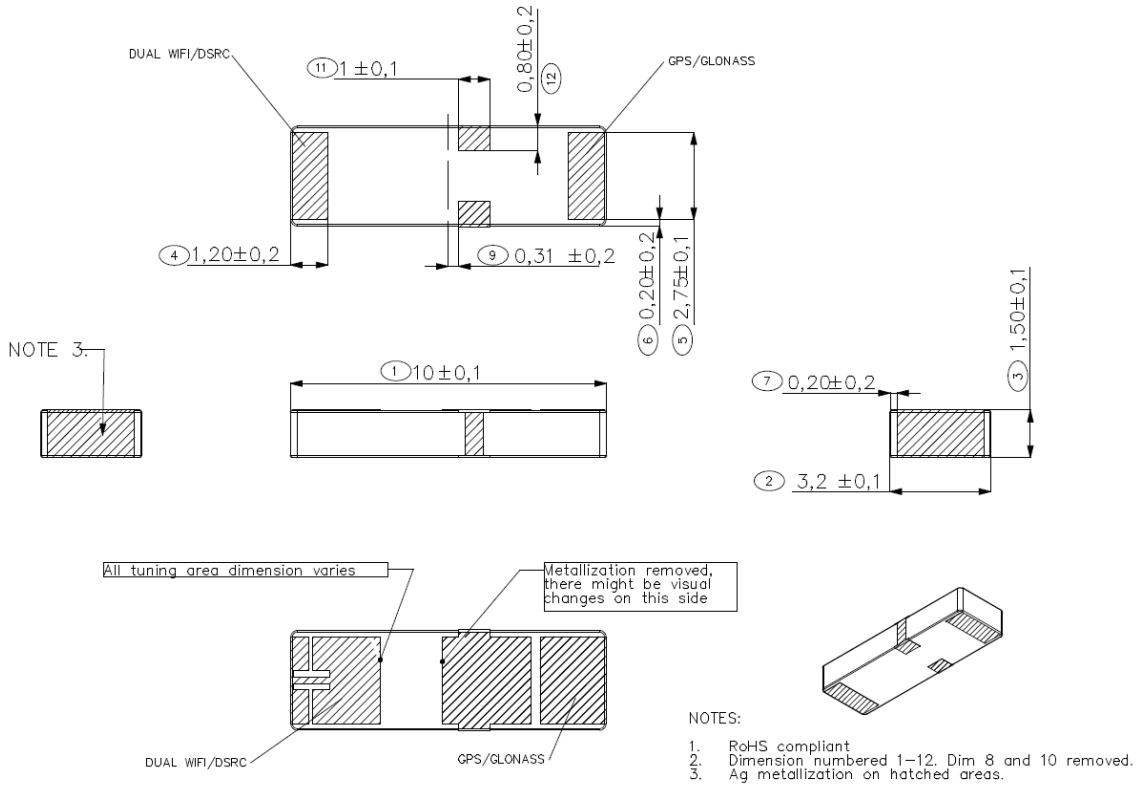

Dimensions: (mm)

Details of antenna pad dimension on the bottom in mm.

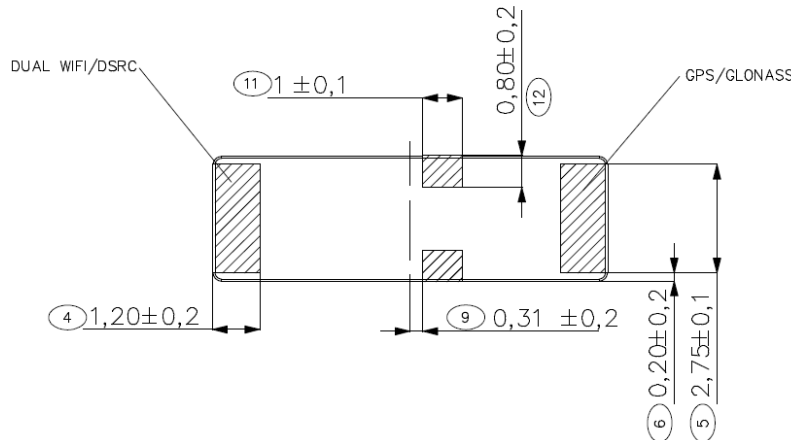

Issue: 1804

In the effort to improve our products, we reserve the right to make changes judged to be necessary.

CONFIDENTIAL AND PROPRIETARY INFORMATION

This document contains confidential and proprietary information of Pulse Electronics, Inc. (Pulse) and is protected by copyright, trade secret and other state and federal laws. Its receipt or possession does not convey any rights to reproduce, disclose its contents, or to manufacture, use or sell anything it may describe. Reproduction, disclosure or use without specific written authorization of Pulse is strictly forbidden.

Description: GNSS-DUAL WIFI-DSRC ANT

Series: CERAMIC CHIP

PART NUMBER: W3095

OTHER SPECIFICATIONS

PCB Layout Recommendation

Top Side

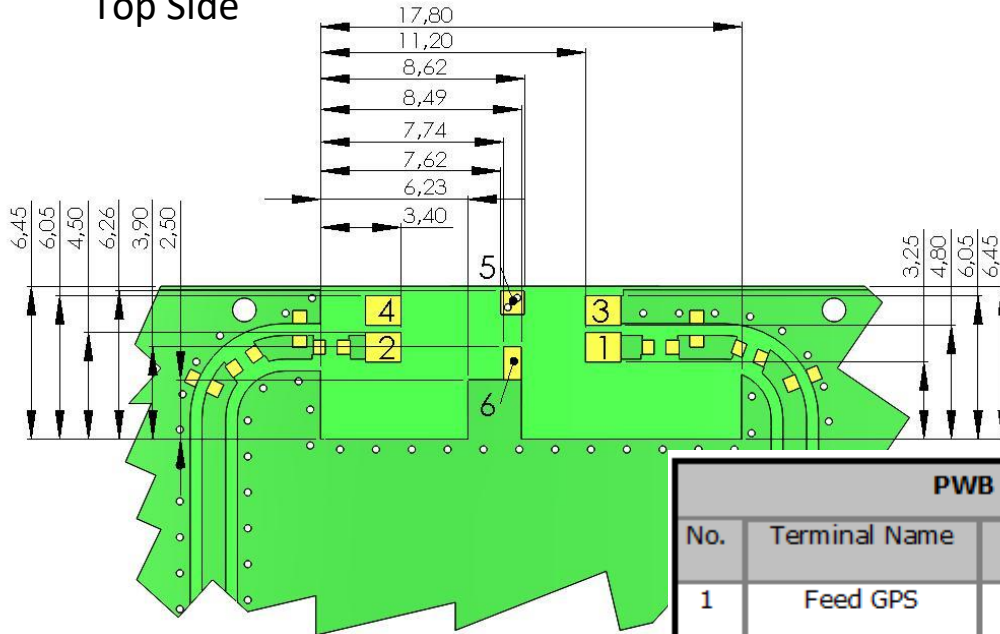

PWB features		
No.	Terminal Name	Terminal Dimensions
1	Feed GPS	1.25 x 1.50 mm
2	Feed 2,4-5,925GHZ	1.25 x 1.50 mm
3	GND	1.25 x 1.50 mm
4	Support pad	1.25 x 1.50 mm
5	GND	1.00 x 1.00 mm
6	GND	1.40x 0.75 mm

Bottom Side

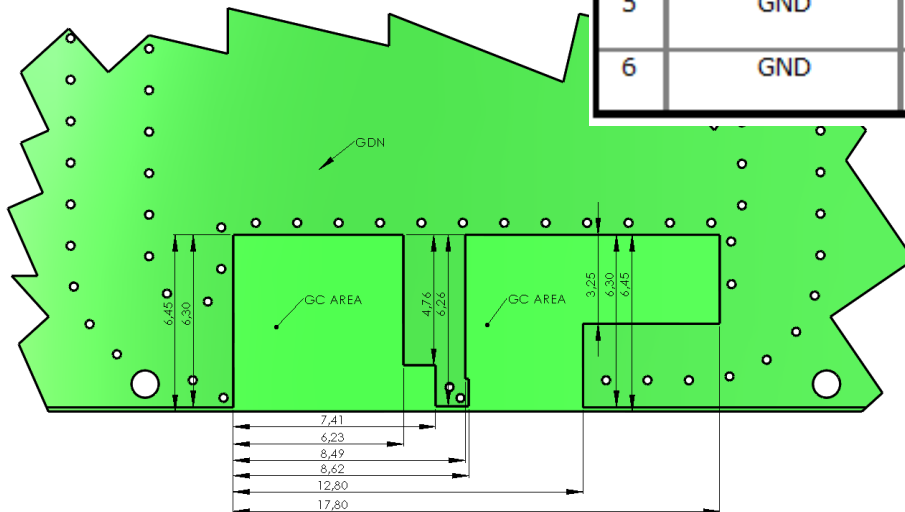

Issue: 1804

In the effort to improve our products, we reserve the right to make changes judged to be necessary.

CONFIDENTIAL AND PROPRIETARY INFORMATION

This document contains confidential and proprietary information of Pulse Electronics, Inc. (Pulse) and is protected by copyright, trade secret and other state and federal laws. Its receipt or possession does not convey any rights to reproduce, disclose its contents, or to manufacture, use or sell anything it may describe. Reproduction, disclosure or use without specific written authorization of Pulse is strictly forbidden.

Description: GNSS-DUAL WIFI-DSRC ANT

Series: CERAMIC CHIP

PART NUMBER: W3095

OTHER SPECIFICATIONS

Antenna Alignment on PCB Layout

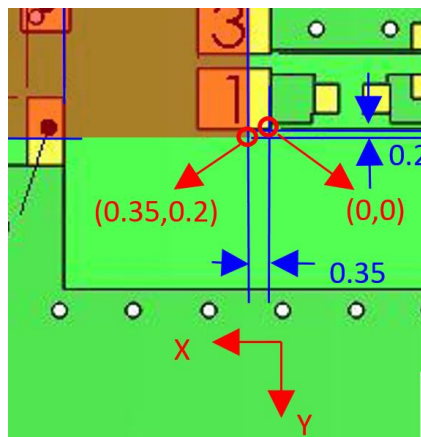
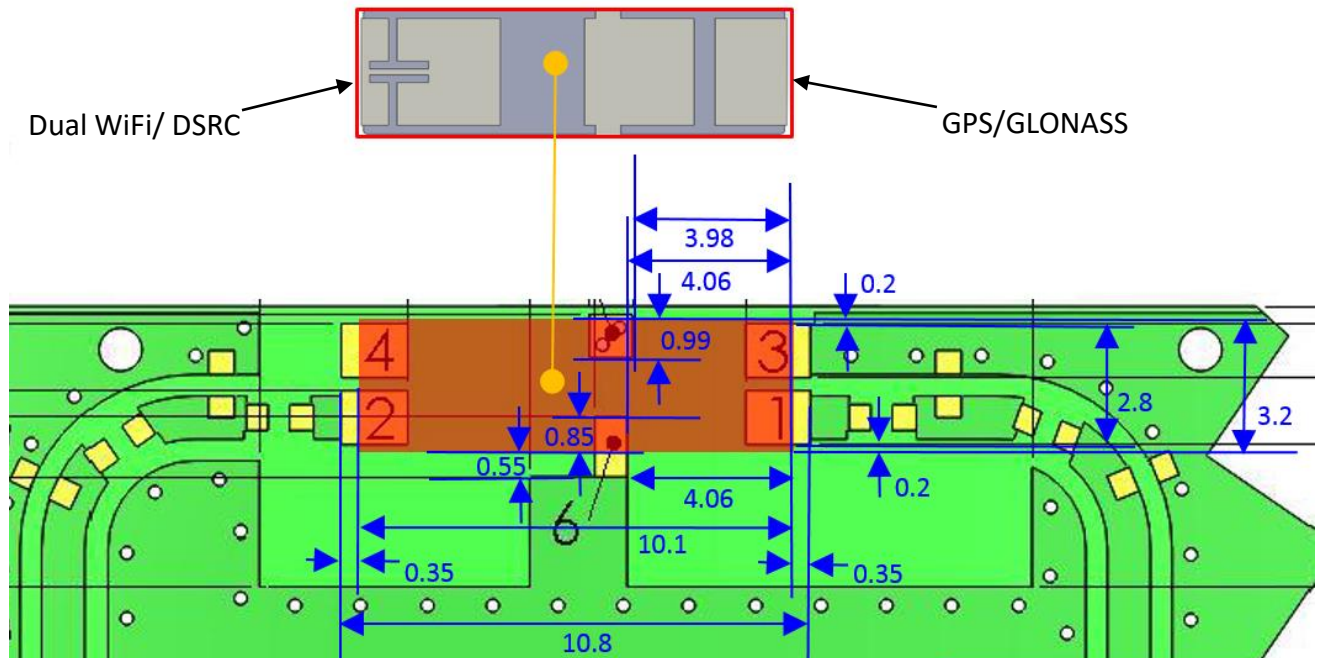

Issue: 1804

In the effort to improve our products, we reserve the right to make changes judged to be necessary.

CONFIDENTIAL AND PROPRIETARY INFORMATION

This document contains confidential and proprietary information of Pulse Electronics, Inc. (Pulse) and is protected by copyright, trade secret and other state and federal laws. Its receipt or possession does not convey any rights to reproduce, disclose its contents, or to manufacture, use or sell anything it may describe. Reproduction, disclosure or use without specific written authorization of Pulse is strictly forbidden.

Description: GNSS-DUAL WIFI-DSRC ANT

Series: CERAMIC CHIP

PART NUMBER: W3095

**OTHER SPECIFICATIONS**

Suggested Matching on PCB

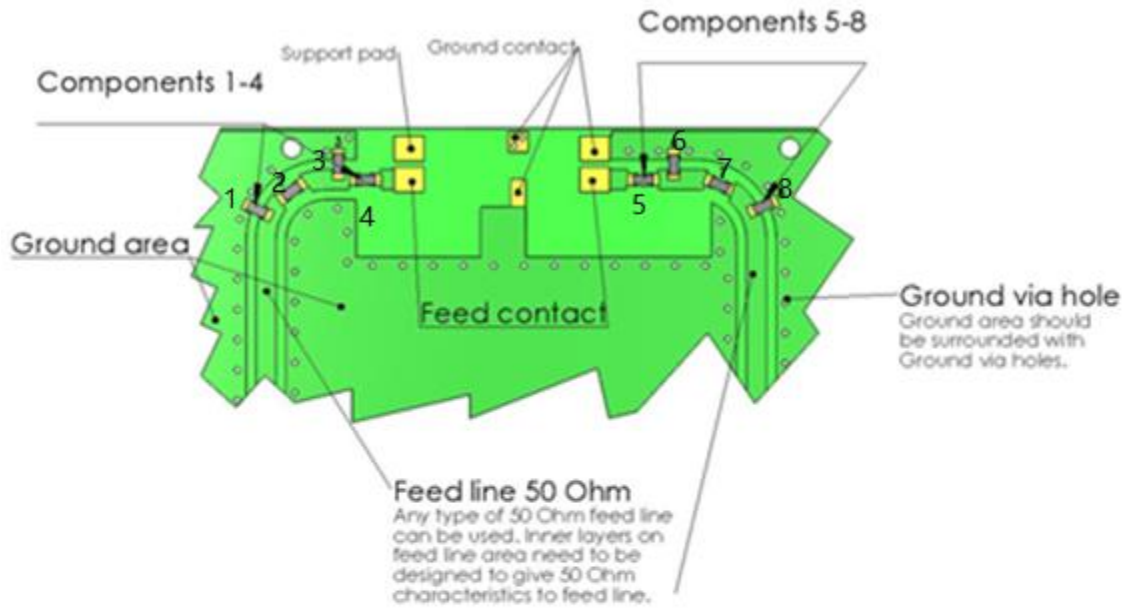

Antenna	Component NO.	Value
2.4-5.925GHz	1	Optional, not in use
2.4-5.925GHz	2	0 Ohm
2.4-5.925GHz	3	2.2nH
2.4-5.925GHz	4	1.2pF
GPS/Glonass	5	0 Ohm
GPS/Glonass	6	1.8pF
GPS/Glonass	7	0 Ohm
GPS/Glonass	8	Optional, not in use

Issue: 1804

In the effort to improve our products, we reserve the right to make changes judged to be necessary.  
CONFIDENTIAL AND PROPRIETARY INFORMATION

This document contains confidential and proprietary information of Pulse Electronics, Inc. (Pulse) and is protected by copyright, trade secret and other state and federal laws. Its receipt or possession does not convey any rights to reproduce, disclose its contents, or to manufacture, use or sell anything it may describe. Reproduction, disclosure or use without specific written authorization of Pulse is strictly forbidden.

Description: GNSS-DUAL WIFI-DSRC ANT

Series: CERAMIC CHIP

PART NUMBER: W3095

CHARTS

Typical GPS/GLONASS antenna Return Loss

LOG

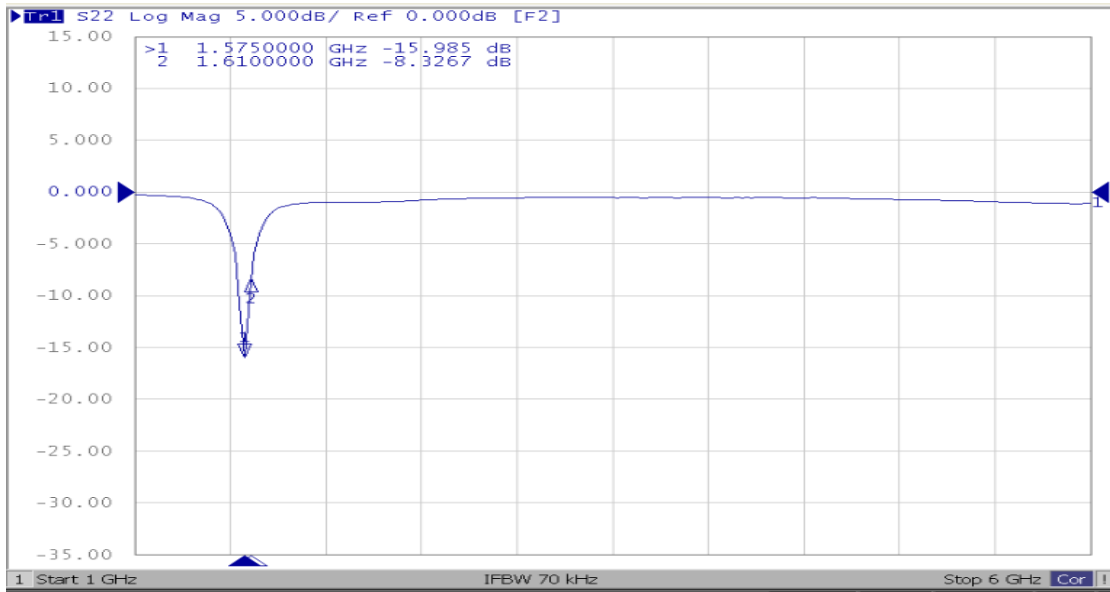

VSWR



Issue: 1804

In the effort to improve our products, we reserve the right to make changes judged to be necessary.

CONFIDENTIAL AND PROPRIETARY INFORMATION

This document contains confidential and proprietary information of Pulse Electronics, Inc. (Pulse) and is protected by copyright, trade secret and other state and federal laws. Its receipt or possession does not convey any rights to reproduce, disclose its contents, or to manufacture, use or sell anything it may describe. Reproduction, disclosure or use without specific written authorization of Pulse is strictly forbidden.



Description: GNSS-DUAL WIFI-DSRC ANT

Series: CERAMIC CHIP

PART NUMBER: W3095

CHARTS

Typical WIFI antenna Return Loss

LOG

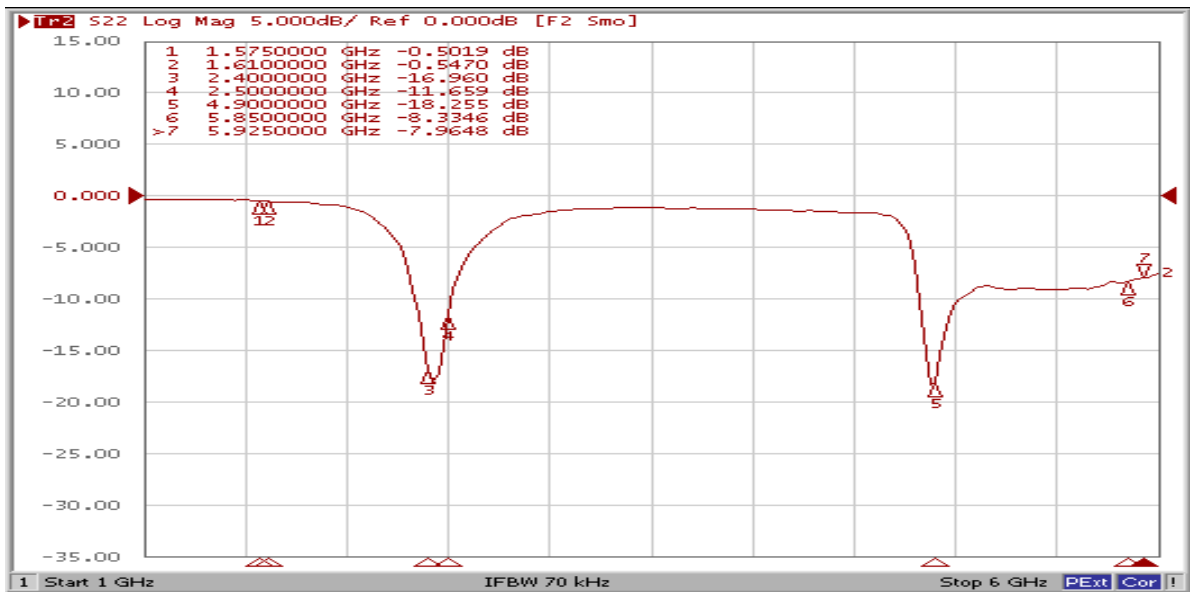

VSWR

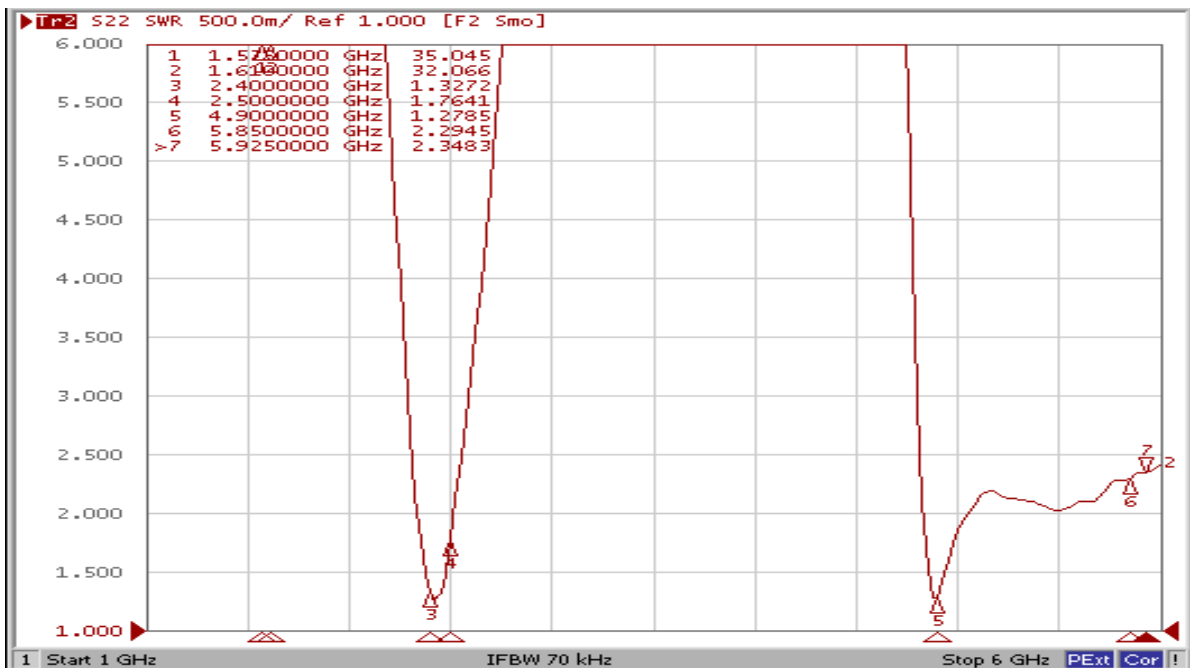

Issue: 1804

In the effort to improve our products, we reserve the right to make changes judged to be necessary.

CONFIDENTIAL AND PROPRIETARY INFORMATION

This document contains confidential and proprietary information of Pulse Electronics, Inc. (Pulse) and is protected by copyright, trade secret and other state and federal laws. Its receipt or possession does not convey any rights to reproduce, disclose its contents, or to manufacture, use or sell anything it may describe. Reproduction, disclosure or use without specific written authorization of Pulse is strictly forbidden.

Description: GNSS-DUAL WIFI-DSRC ANT

Series: CERAMIC CHIP

PART NUMBER: W3095

CHARTS

Typical Isolation

Isolation

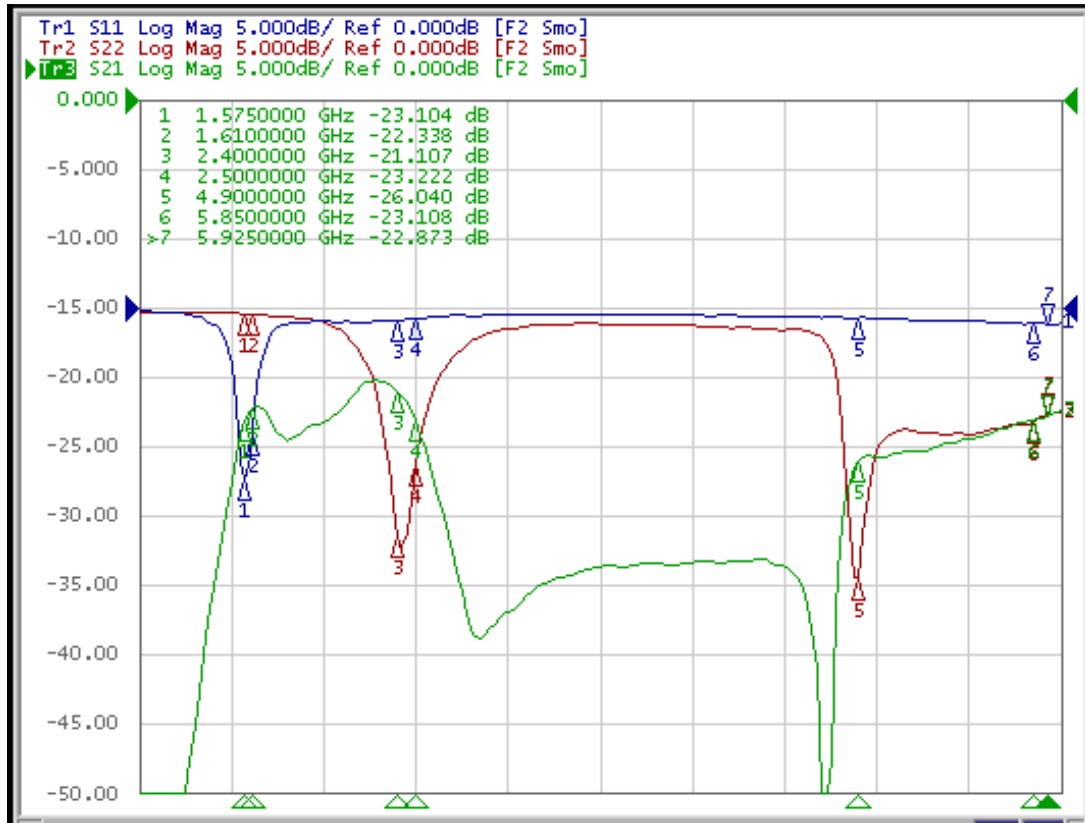

Issue: 1804

In the effort to improve our products, we reserve the right to make changes judged to be necessary.

CONFIDENTIAL AND PROPRIETARY INFORMATION

This document contains confidential and proprietary information of Pulse Electronics, Inc. (Pulse) and is protected by copyright, trade secret and other state and federal laws. Its receipt or possession does not convey any rights to reproduce, disclose its contents, or to manufacture, use or sell anything it may describe. Reproduction, disclosure or use without specific written authorization of Pulse is strictly forbidden.

Description: GNSS-DUAL WIFI-DSRC ANT

Series: CERAMIC CHIP

PART NUMBER: W3095

CHARTS

Typical Antenna Total Efficiency

GPS/GLONASS

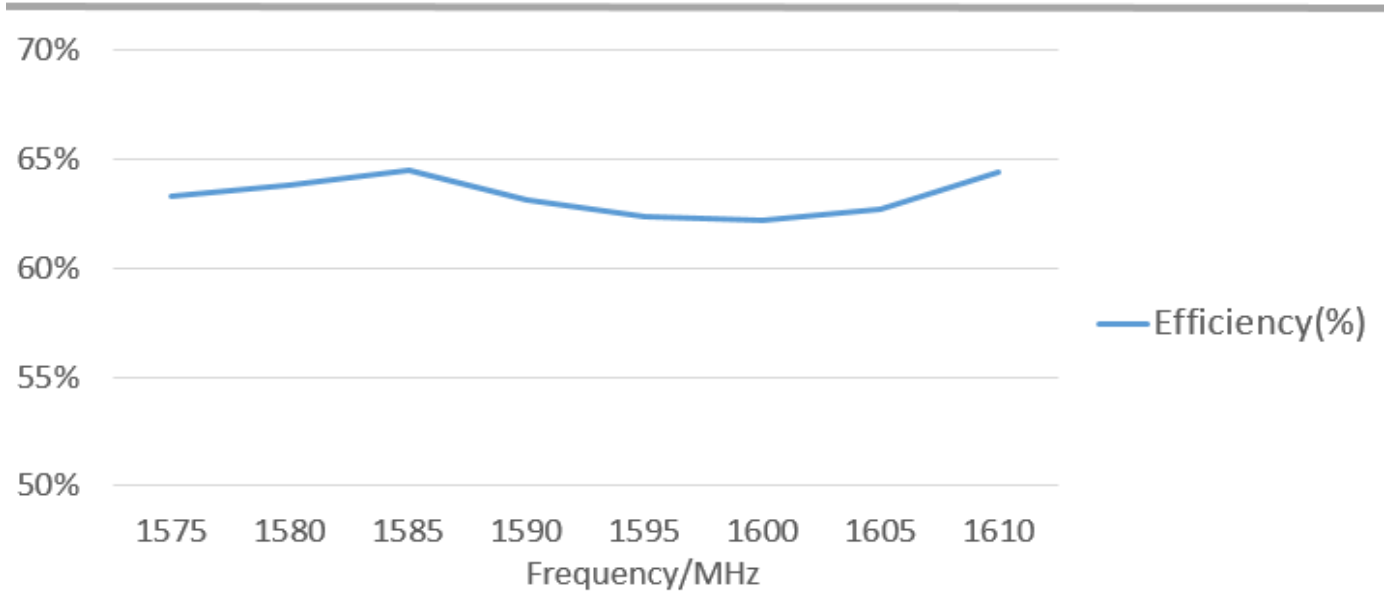

WIFI/DSRC

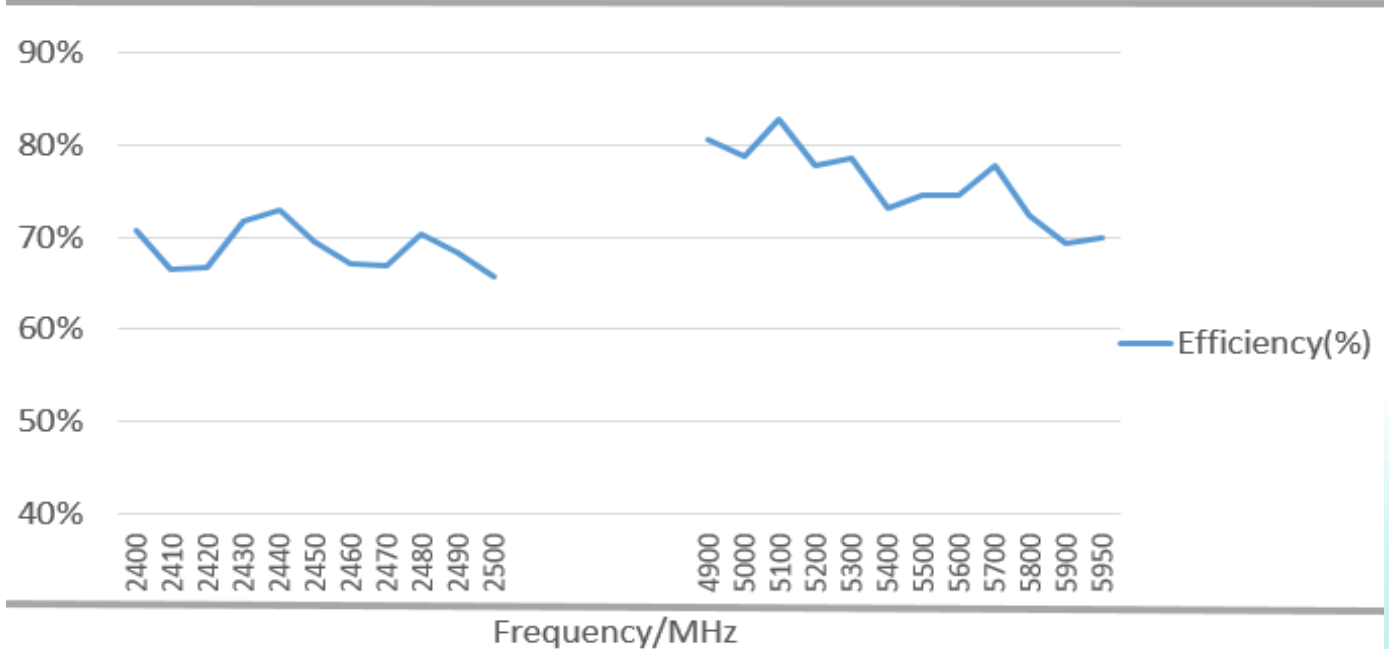

Issue: 1804

In the effort to improve our products, we reserve the right to make changes judged to be necessary.

CONFIDENTIAL AND PROPRIETARY INFORMATION

This document contains confidential and proprietary information of Pulse Electronics, Inc. (Pulse) and is protected by copyright, trade secret and other state and federal laws. Its receipt or possession does not convey any rights to reproduce, disclose its contents, or to manufacture, use or sell anything it may describe. Reproduction, disclosure or use without specific written authorization of Pulse is strictly forbidden.



Description: GNSS-DUAL WIFI-DSRC ANT

Series: CERAMIC CHIP

PART NUMBER: W3095

CHARTS

Typical Antenna Peak Gain

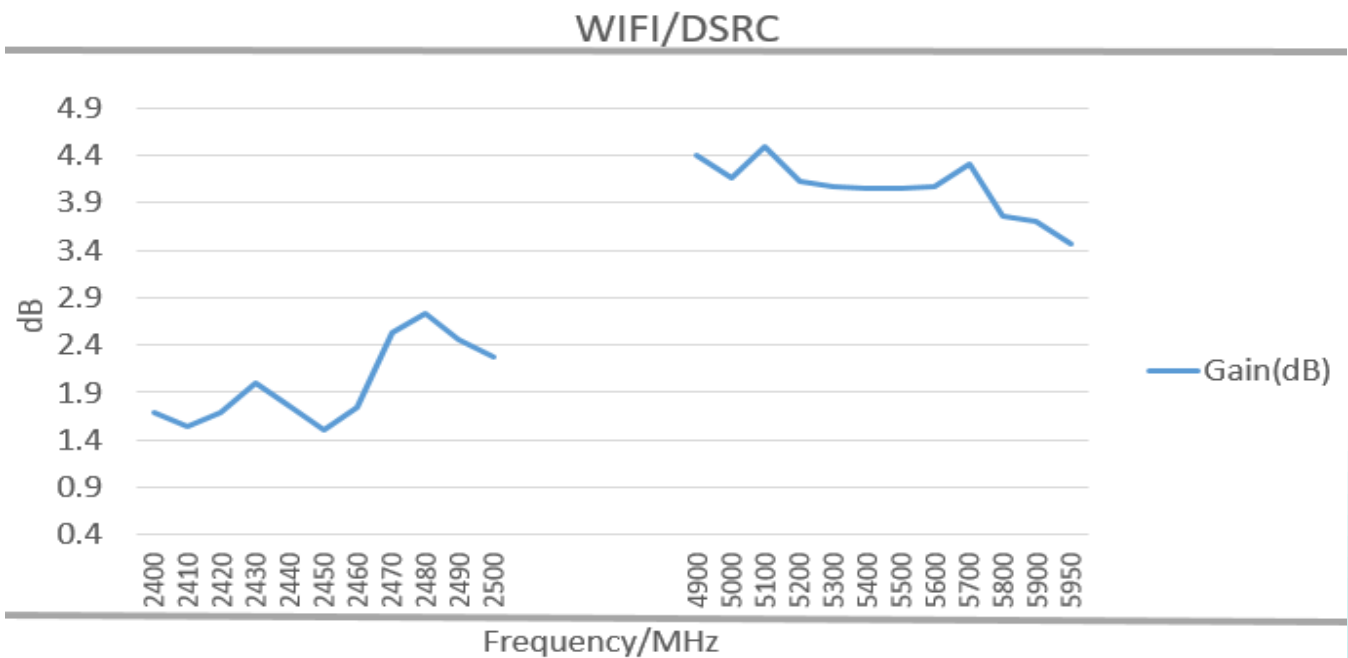
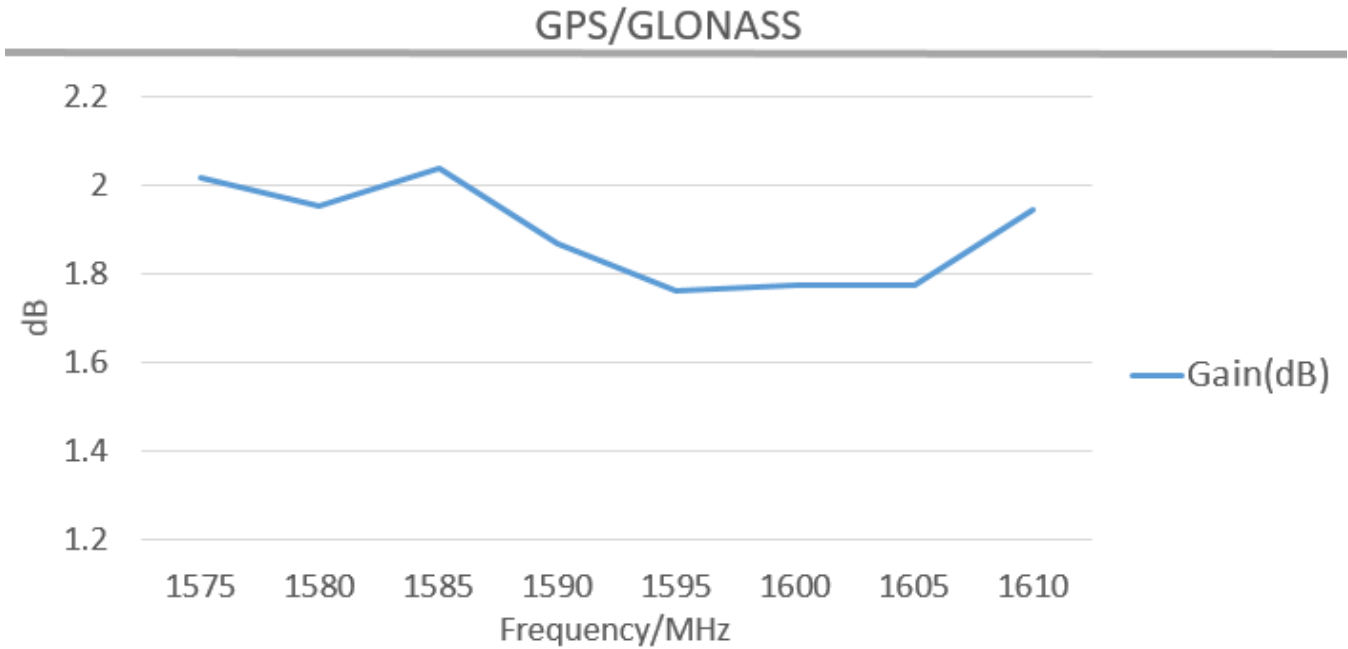

Issue: 1804

In the effort to improve our products, we reserve the right to make changes judged to be necessary.

CONFIDENTIAL AND PROPRIETARY INFORMATION

This document contains confidential and proprietary information of Pulse Electronics, Inc. (Pulse) and is protected by copyright, trade secret and other state and federal laws. Its receipt or possession does not convey any rights to reproduce, disclose its contents, or to manufacture, use or sell anything it may describe. Reproduction, disclosure or use without specific written authorization of Pulse is strictly forbidden.



Description: GNSS-DUAL WIFI-DSRC ANT

Series: CERAMIC CHIP

PART NUMBER: W3095

CHARTS

Typical free space radiation pattern—GPS/GLONASS

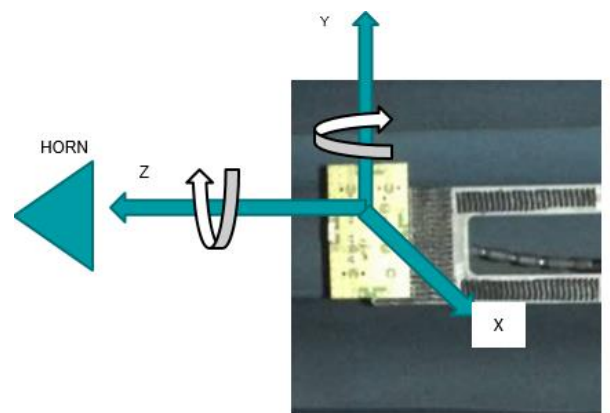
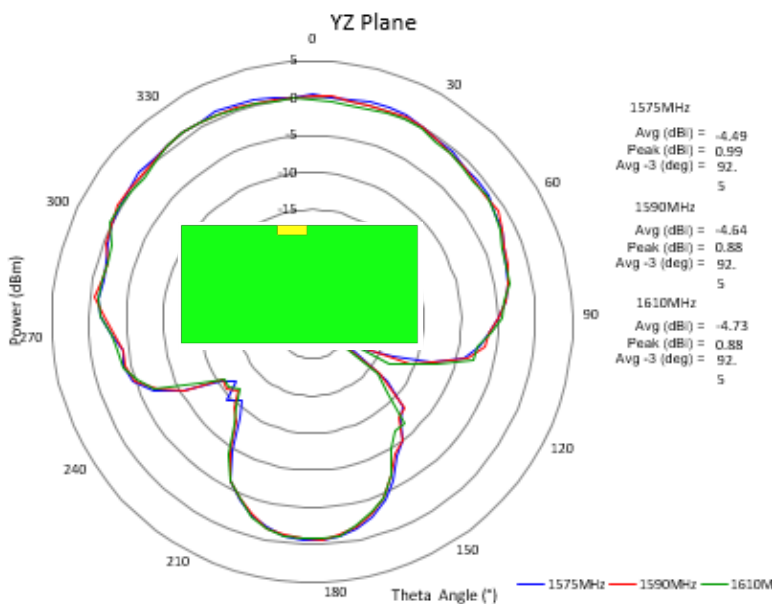
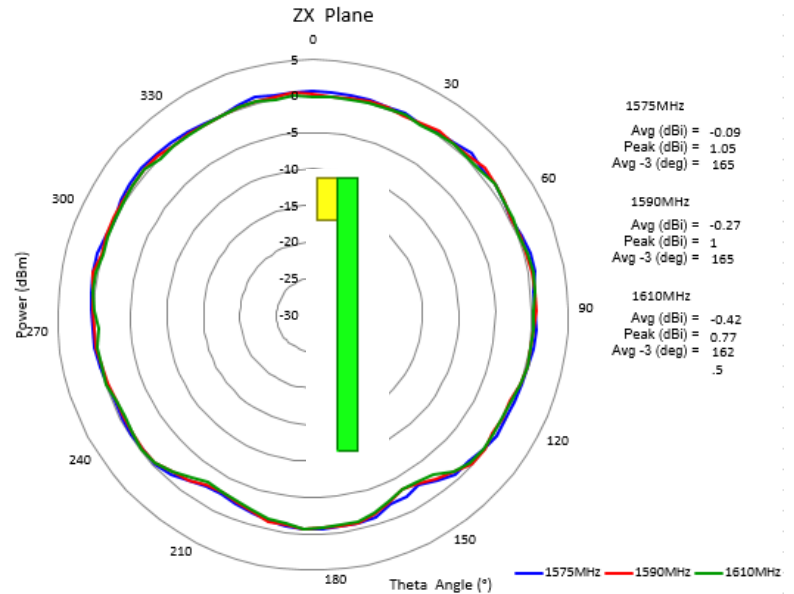
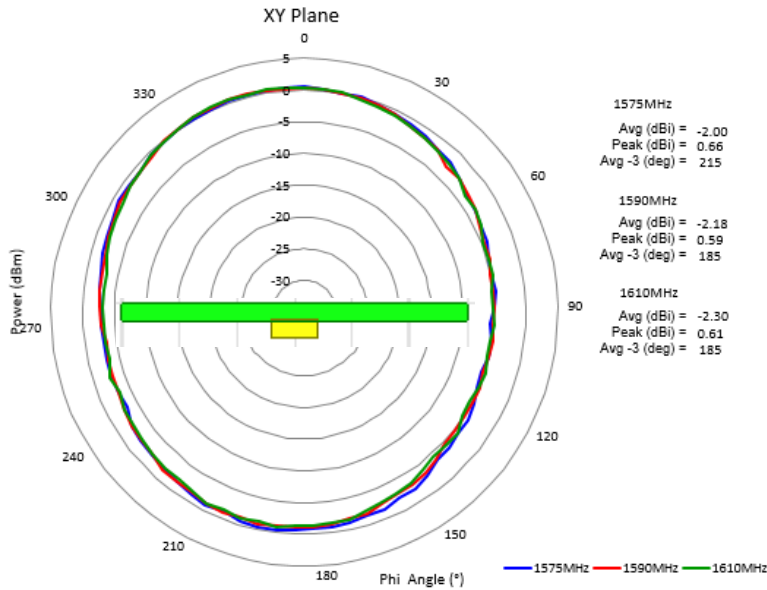

Issue: 1804

In the effort to improve our products, we reserve the right to make changes judged to be necessary.

CONFIDENTIAL AND PROPRIETARY INFORMATION

This document contains confidential and proprietary information of Pulse Electronics, Inc. (Pulse) and is protected by copyright, trade secret and other state and federal laws. Its receipt or possession does not convey any rights to reproduce, disclose its contents, or to manufacture, use or sell anything it may describe. Reproduction, disclosure or use without specific written authorization of Pulse is strictly forbidden.

Description: GNSS-DUAL WIFI-DSRC ANT

Series: CERAMIC CHIP

PART NUMBER: W3095

CHARTS

Typical free space radiation pattern—2.4G

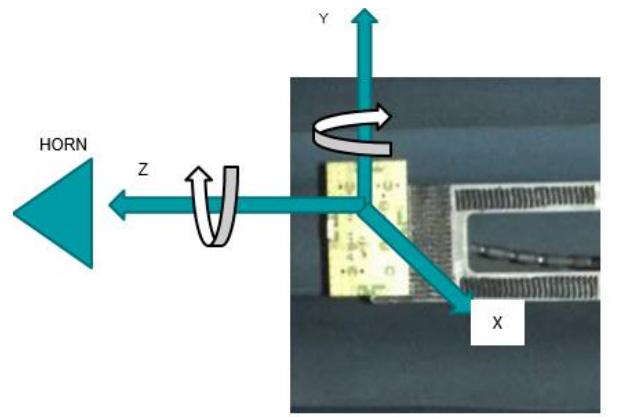
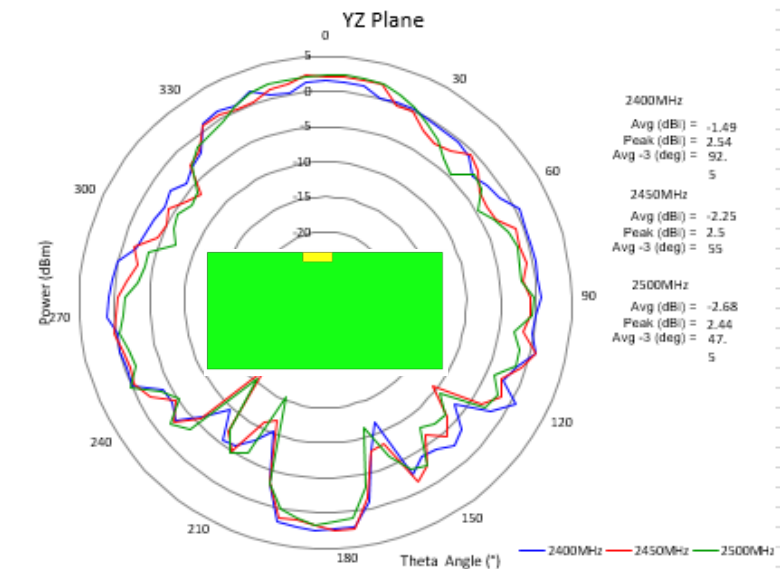
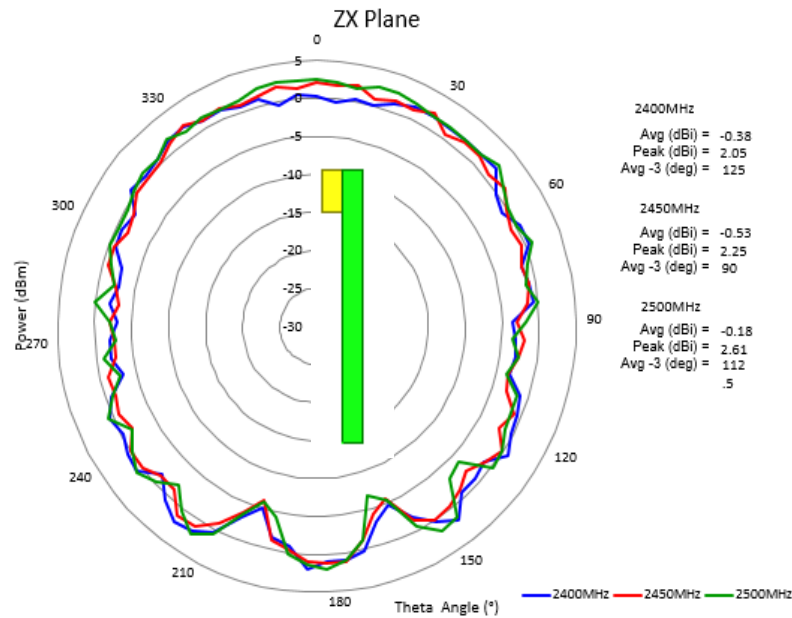
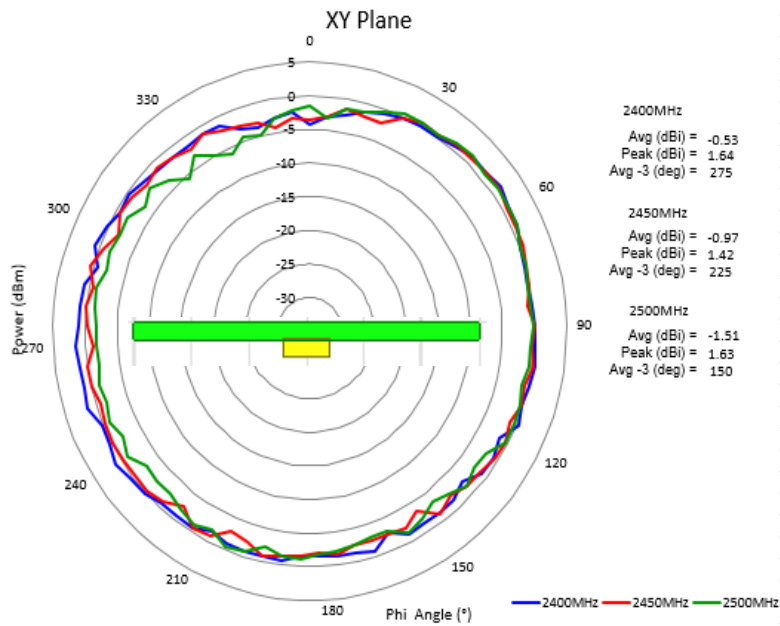

Issue: 1804

In the effort to improve our products, we reserve the right to make changes judged to be necessary.

CONFIDENTIAL AND PROPRIETARY INFORMATION

This document contains confidential and proprietary information of Pulse Electronics, Inc. (Pulse) and is protected by copyright, trade secret and other state and federal laws. Its receipt or possession does not convey any rights to reproduce, disclose its contents, or to manufacture, use or sell anything it may describe. Reproduction, disclosure or use without specific written authorization of Pulse is strictly forbidden.

Description: GNSS-DUAL WIFI-DSRC ANT

Series: CERAMIC CHIP

PART NUMBER: W3095

CHARTS

Typical free space radiation pattern—5G

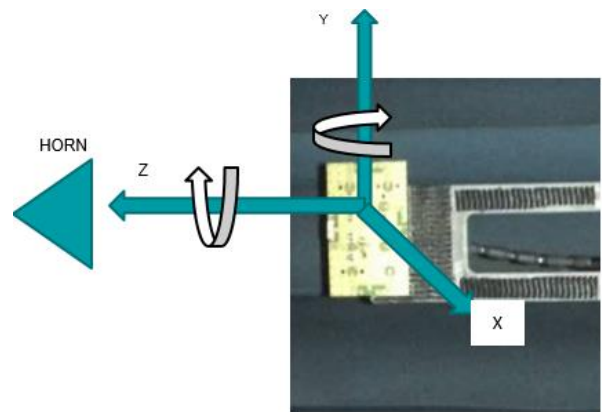
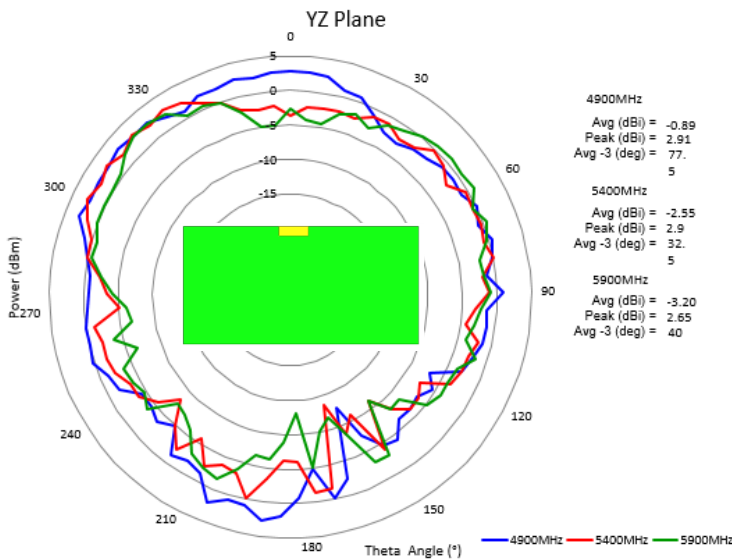
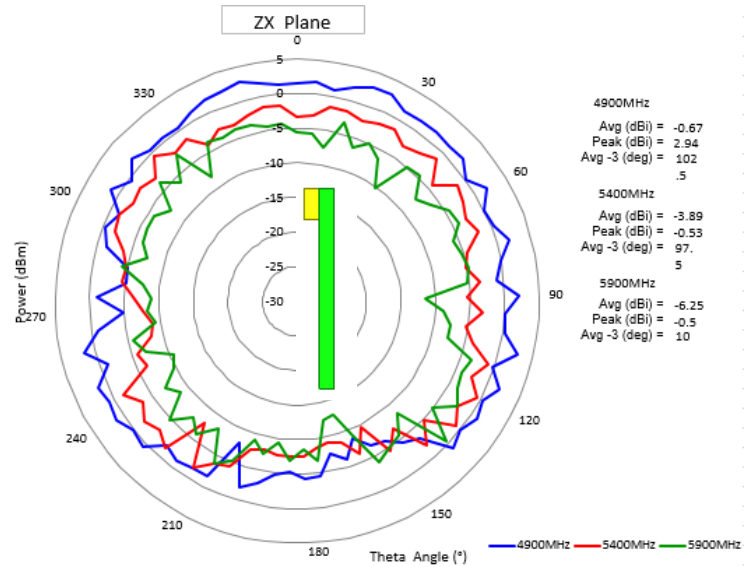
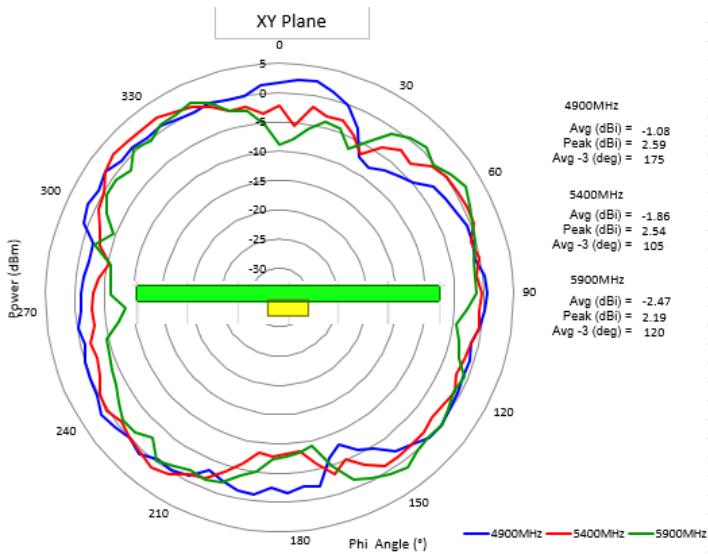

Issue: 1804

In the effort to improve our products, we reserve the right to make changes judged to be necessary.

CONFIDENTIAL AND PROPRIETARY INFORMATION

This document contains confidential and proprietary information of Pulse Electronics, Inc. (Pulse) and is protected by copyright, trade secret and other state and federal laws. Its receipt or possession does not convey any rights to reproduce, disclose its contents, or to manufacture, use or sell anything it may describe. Reproduction, disclosure or use without specific written authorization of Pulse is strictly forbidden.

Description: GNSS-DUAL WIFI-DSRC ANT

Series: CERAMIC CHIP

PART NUMBER: W3095

PACKAGING

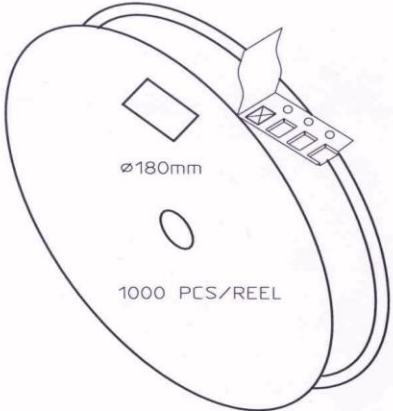

CARRIER TAPE H85-00188  
 width=24,00 depth=2.20  
 COVER TAPE H85-00159  
 width=21.20

LENGTH OF TAPE:

- Leader section: min 350 mm before component section
- Trailer section: min 40 mm after component section.

Empty part cavities at leader and trailer section of the tape must be sealed with top cover tape.

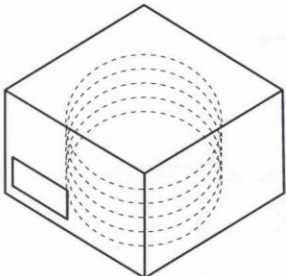

BOX H85-00128 (182x182x125)	1 pcs
- LABEL	1 pcs/BOX
REEL H85-00160 (D180, W28)	4 pcs
- REEL LABEL	1 pcs/REEL

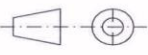
MATERIAL					
HANDLINGS					
 	RATIO	DRWN	160107 PeHa	H	
		DGNER		G	
PRODUCT			CHKD		F
H90-OY113-F01P01			APPRD		E
			APPRD BY		D
DENOMINATION					C
PACKING FORM					B
					A
		VERSION	MOD/DATE/NAME		

Issue: 1804

In the effort to improve our products, we reserve the right to make changes judged to be necessary.

CONFIDENTIAL AND PROPRIETARY INFORMATION

This document contains confidential and proprietary information of Pulse Electronics, Inc. (Pulse) and is protected by copyright, trade secret and other state and federal laws. Its receipt or possession does not convey any rights to reproduce, disclose its contents, or to manufacture, use or sell anything it may describe. Reproduction, disclosure or use without specific written authorization of Pulse is strictly forbidden.



Description: GNSS-DUAL WIFI-DSRC ANT

Series: CERAMIC CHIP

PART NUMBER: W3095

### Block Orientation

Antenna soldering pads facing down to the bottom of the carrier tape

Top view of the carrier tape

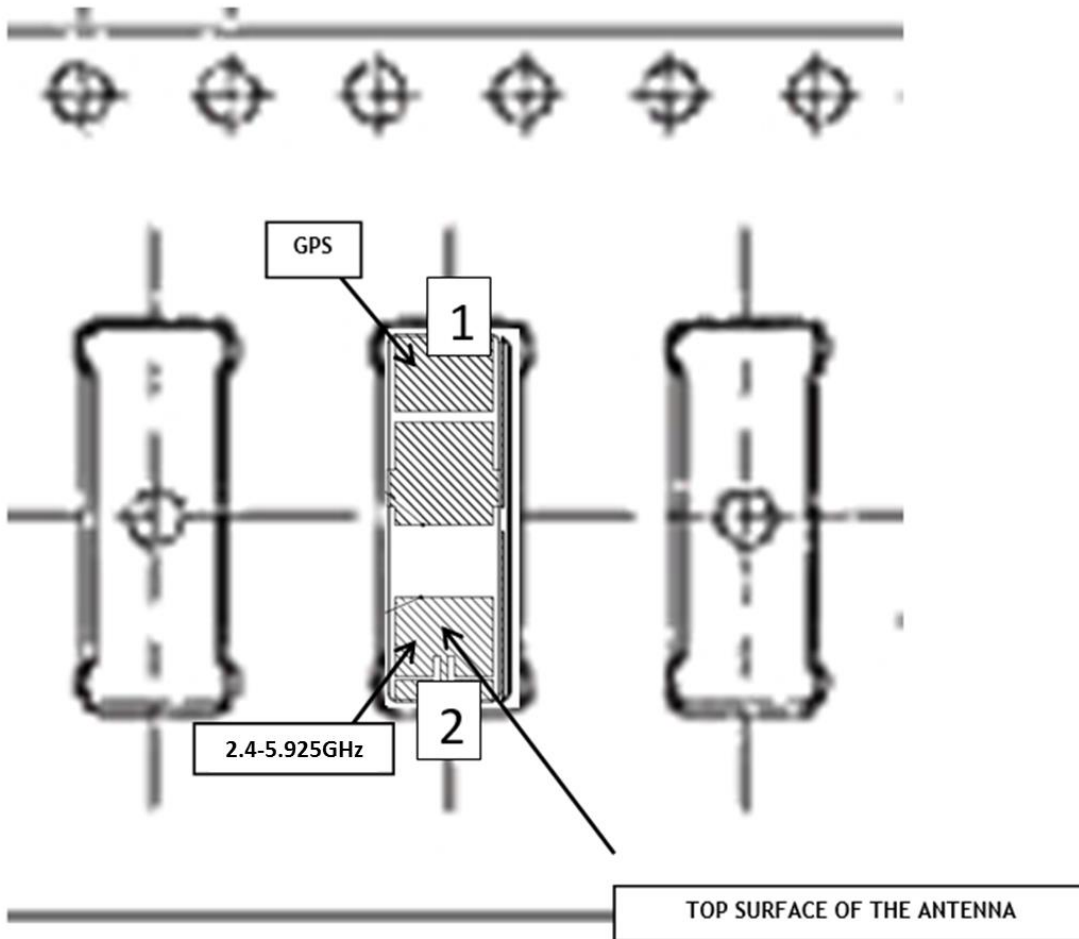

Issue: 1804

In the effort to improve our products, we reserve the right to make changes judged to be necessary.

CONFIDENTIAL AND PROPRIETARY INFORMATION

This document contains confidential and proprietary information of Pulse Electronics, Inc. (Pulse) and is protected by copyright, trade secret and other state and federal laws. Its receipt or possession does not convey any rights to reproduce, disclose its contents, or to manufacture, use or sell anything it may describe. Reproduction, disclosure or use without specific written authorization of Pulse is strictly forbidden.