

### EC103xx & SxSx Series

RoHS

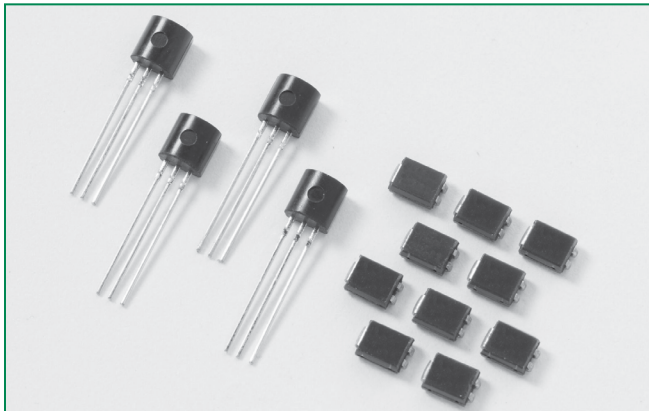

#### Description

Excellent unidirectional switches for phase control applications such as heating and motor speed controls.

Sensitive gate SCRs are easily triggered with microAmps of current as furnished by sense coils, proximity switches, and microprocessors.

#### Features & Benefits

- RoHS compliant
- Glass – passivated junctions
- Voltage capability up to 600 V
- Surge capability up to 20 A

#### Main Features

| Symbol            | Value      | Unit    |
|-------------------|------------|---------|
| $I_{T(RMS)}$      | 0.8        | A       |
| $V_{DRM}/V_{RRM}$ | 400 to 600 | V       |
| $I_{GT}$          | 12 to 500  | $\mu A$ |

#### Schematic Symbol

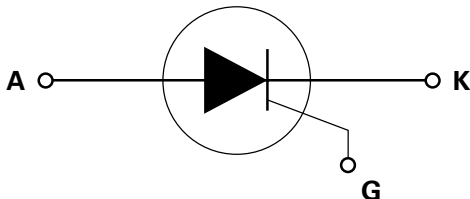

#### Applications

Typical applications are capacitive discharge systems for strobe lights and gas engine ignition. Also controls for power tools, home/brown goods and white goods appliances.

#### Additional Information



Datasheet



Resources



Samples

#### Absolute Maximum Ratings – Sensitive SCRs

| Symbol       | Parameter                                 | Test Conditions  | Value      | Unit       |
|--------------|---|--|------------|------------|
| $I_{T(RMS)}$ | RMS on-state current                      | $T_c = 75^\circ C$   | 0.8        | A          |
| $I_{T(AV)}$  | Average on-state current                  | $T_c = 75^\circ C$   | 0.51       | A          |
| $I_{TSM}$    | Peak non-repetitive surge current         | single half cycle; $f = 50\text{Hz}$ ;<br>$T_J(\text{initial}) = 25^\circ C$ | 16         | A          |
|              |   | single half cycle; $f = 60\text{Hz}$ ;<br>$T_J(\text{initial}) = 25^\circ C$ | 20         |            |
| $I^2t$       | $I^2t$ Value for fusing                   | $t_p = 8.3 \text{ ms}$   | 1.6        | $A^2s$     |
| $di/dt$      | Critical rate of rise of on-state current | $f = 60 \text{ Hz}$ ; $T_J = 110^\circ C$                                    | 50         | $A/\mu s$  |
| $I_{GM}$     | Peak gate current                         | $T_J = 110^\circ C$  | 1          | A          |
| $P_{G(AV)}$  | Average gate power dissipation            | $T_J = 110^\circ C$  | 0.1        | W          |
| $T_{stg}$    | Storage temperature range                 |  | -40 to 150 | $^\circ C$ |
| $T_J$        | Operating junction temperature range      |  | -40 to 110 | $^\circ C$ |

**Electrical Characteristics (T<sub>J</sub> = 25°C, unless otherwise specified)**

| Symbol          | Test Conditions   |      |      | Value           |                 |                           |                 | Unit |
|-----------------|---|------|------|-----------------|-----------------|---------------------------|-----------------|------|
|                 |   |      |      | SxS1<br>EC103X1 | SxS2<br>EC103X2 | SxS /<br>2N6565<br>EC103X | SxS3<br>EC103X3 |      |
| I <sub>GT</sub> | V <sub>D</sub> = 6V; R <sub>L</sub> = 100 Ω   |      | MAX. | 12              | 50              | 200                       | 500             | μA   |
| V <sub>GT</sub> |   |      | MAX. | 0.8             |                 |                           |                 | V    |
| dv/dt           | V <sub>D</sub> = V <sub>DRM</sub> ; R <sub>GK</sub> = 1kΩ                           | 400V | MIN. | 20              | 25              | 30                        | 40              | V/μs |
|                 |   | 600V |      | 10              | 10              | 15                        | 20              |      |
| V <sub>GD</sub> | V <sub>D</sub> = V <sub>DRM</sub> ; R <sub>L</sub> = 3.3 kΩ; T <sub>J</sub> = 110°C |      | MIN. | 0.2             | 0.25            |                           |                 | V    |
| I <sub>H</sub>  | I <sub>T</sub> = 20mA (initial), R <sub>GK</sub> = 1kΩ                              |      | MAX. | 5               |                 |                           | 8               | mA   |
| t <sub>q</sub>  | (1)   |      | MAX. | 60              |                 | 50                        | 45              | μs   |
| t <sub>gt</sub> | I <sub>G</sub> = 2 × I <sub>GT</sub> ; PW = 15μs; I <sub>T</sub> = 1.6A             |      | TYP. | 2               | 5               | 20                        | 30              | μs   |

(1) I<sub>T</sub>=1A; t<sub>p</sub>=50μs; dv/dt=5V/μs; di/dt=-5A/μs

**Static Characteristics**

| Symbol                              | Test Conditions  |                        |      | Value | Unit |    |
|-------------------------------------|--|------------------------|------|-------|------|----|
| V <sub>TM</sub>                     | I <sub>T</sub> = 1.2A; t <sub>p</sub> = 380 μs               |                        |      | MAX.  | 1.7  | V  |
| I <sub>DRM</sub> / I <sub>RRM</sub> | V <sub>DRM</sub> = V <sub>RRM</sub><br>R <sub>GK</sub> = 1kΩ | T <sub>J</sub> = 25°C  | MAX. |       | 1    | μA |
|                                     |  | T <sub>J</sub> = 100°C |      |       | 50   |    |
|                                     |  | T <sub>J</sub> = 110°C |      |       | 100  |    |

**Thermal Resistances**

| Symbol              | Parameter             |                | Value          | Unit |      |
|---------------------|-----------------------|----------------|----------------|------|------|
| R <sub>θ(J-C)</sub> | Junction to case (AC) | EC103xy/2N6565 | 75             | °C/W |      |
|                     |                       | SxSy           | 60*            |      |      |
| R <sub>θ(J-A)</sub> | Junction to ambient   |                | EC103xy/2N6565 | 160  | °C/W |

Notes: x = voltage, y = sensitivity

\* = Mounted on 1 cm<sup>2</sup> copper (two-ounce) foil surface

**Figure 1: Normalized DC Gate Trigger Current vs. Junction Temperature**



**Figure 2: Normalized DC Gate Trigger Voltage vs. Junction Temperature**

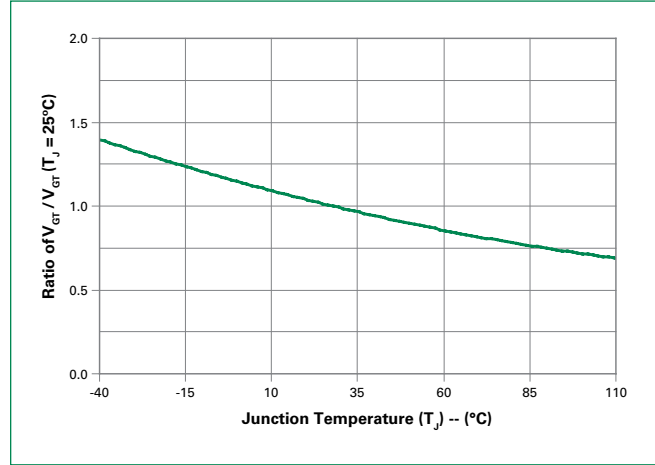

**Figure 3: Normalized DC Holding Current vs. Junction Temperature**



**Figure 4: On-State Current vs. On-State Voltage (Typical)**

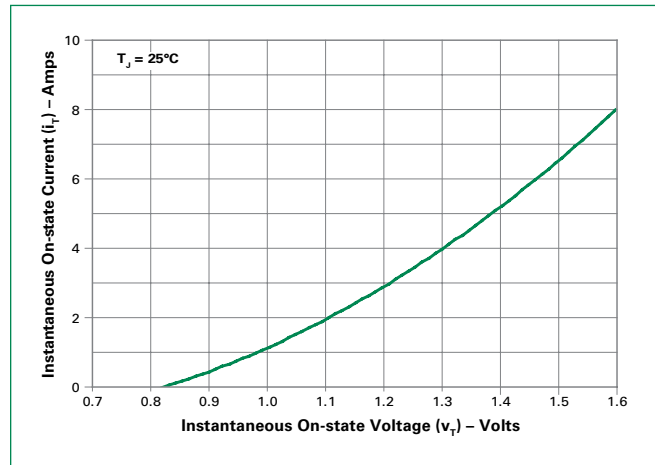

**Figure 5: Power Dissipation (Typical) vs. RMS On-State Current**



**Figure 6: Maximum Allowable Case Temperature vs. RMS On-State Current**

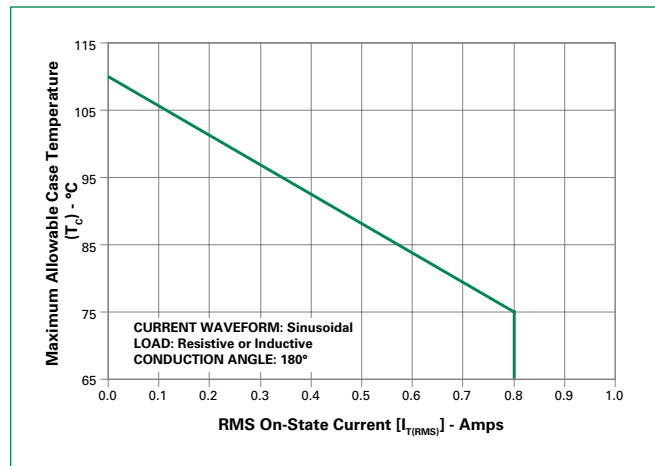

**Figure 7: Maximum Allowable Case Temperature vs. Average On-State Current**

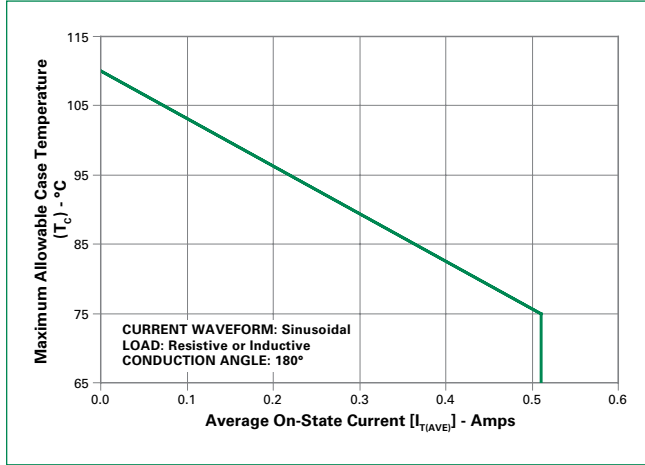

**Figure 8: Maximum Allowable Ambient Temperature vs. RMS On-State Current**

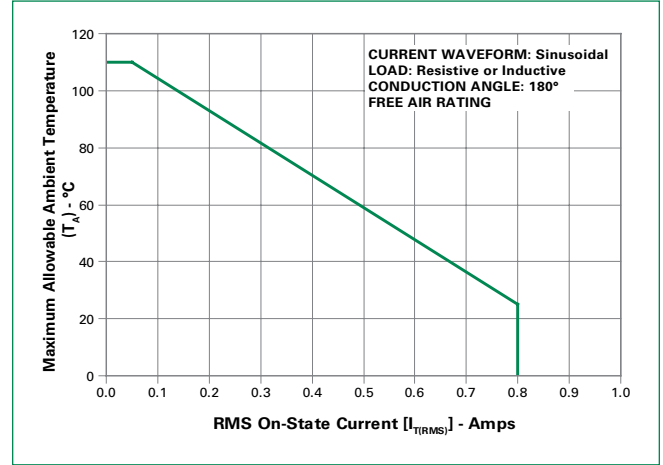

**Figure 9: Maximum Allowable Ambient Temperature vs. Average On-State Current**

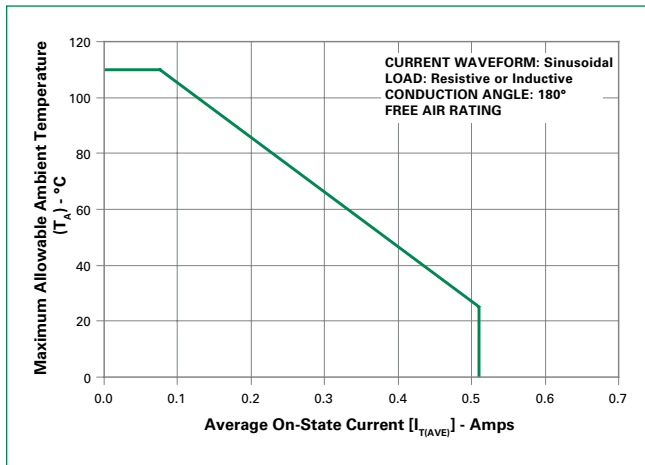

**Figure 10: Peak Capacitor Discharge Current**

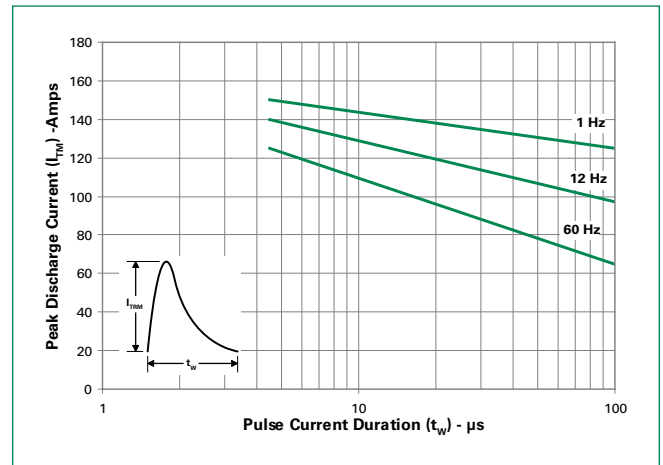

**Figure 11: Peak Repetitive Sinusoidal Pulse Current**

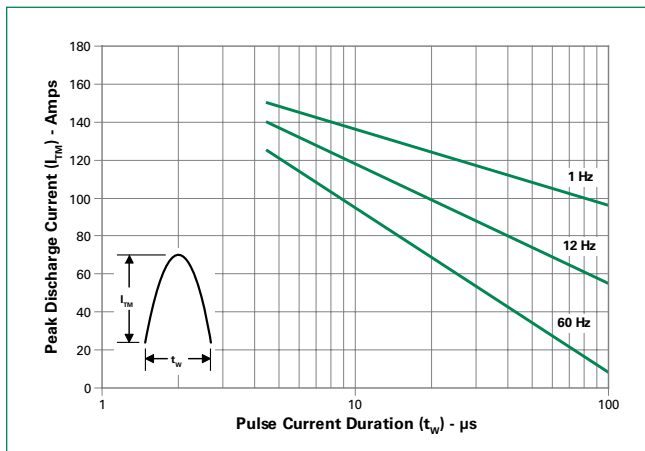

**Figure 12: Surge Peak On-State Current vs. Number of Cycles**

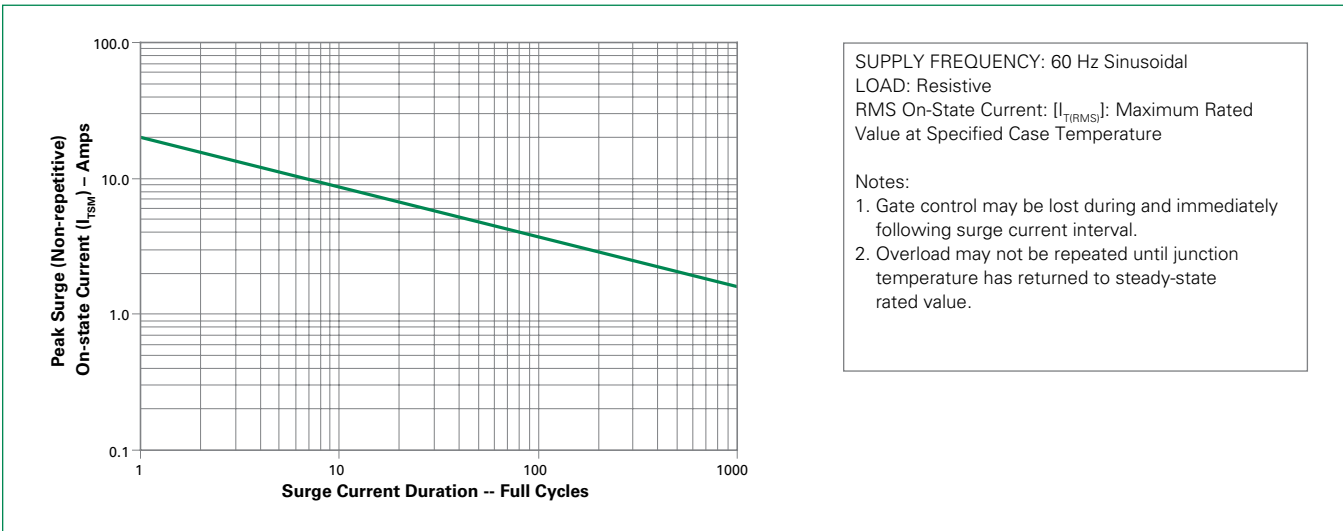

**Figure 13: Simple Test Circuit for Gate Trigger Voltage and Current**

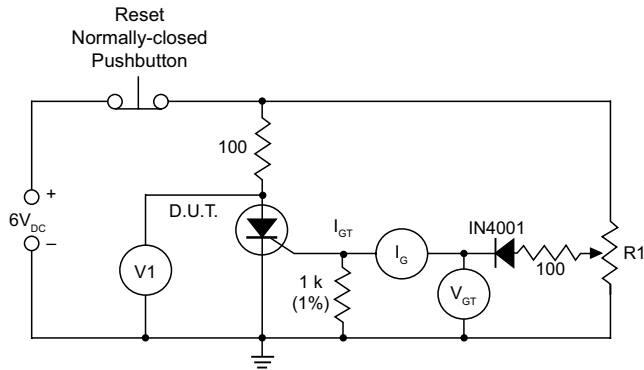

Note: V1 — 0 V to 10 V dc meter  
V<sub>GT</sub> — 0 V to 1 V dc meter  
I<sub>G</sub> — 0 mA to 1 mA dc milliammeter  
R1 — 1 k potentiometer

To measure gate trigger voltage and current, raise gate voltage (V<sub>GT</sub>) until meter reading V1 drops from 6 V to 1 V. Gate trigger voltage is the reading on V<sub>GT</sub> just prior to V1 dropping. Gate trigger current I<sub>GT</sub> can be computed from the relationship

$$I_{GT} = I_G \cdot \frac{V_{GT}}{1000} \text{ Amps}$$

where I<sub>G</sub> is reading (in amperes) on meter just prior to V1 dropping

Note: I<sub>GT</sub> may turn out to be a negative quantity (trigger current flows out from gate lead). If negative current occurs, I<sub>GT</sub> value is not a valid reading. Remove 1 k resistor and use I<sub>G</sub> as the more correct I<sub>GT</sub> value. This will occur on 12 μA gate products.

### Soldering Parameters

|  |                                    |                         |
|--|------------------------------------|-------------------------|
| Reflow Condition                                       |                                    | Pb – Free assembly      |
| Pre Heat   | - Temperature Min ( $T_{s(min)}$ ) | 150°C                   |
|  | - Temperature Max ( $T_{s(max)}$ ) | 200°C                   |
|  | - Time (min to max) ( $t_s$ )      | 60 – 180 secs           |
| Average ramp up rate (Liquidus Temp) ( $T_L$ ) to peak |                                    | 5°C/second max          |
| $T_{s(max)}$ to $T_L$ - Ramp-up Rate                   |                                    | 5°C/second max          |
| Reflow   | - Temperature ( $T_L$ ) (Liquidus) | 217°C                   |
|  | - Temperature ( $t_l$ )            | 60 – 150 seconds        |
| Peak Temperature ( $T_p$ )                             |                                    | 260 <sup>+0/-5</sup> °C |
| Time within 5°C of actual peak Temperature ( $t_p$ )   |                                    | 20 – 40 seconds         |
| Ramp-down Rate   |                                    | 5°C/second max          |
| Time 25°C to peak Temperature ( $T_p$ )                |                                    | 8 minutes Max.          |
| Do not exceed  |                                    | 280°C                   |



### Physical Specifications

|                        |   |
|------------------------|---|
| <b>Terminal Finish</b> | 100% Matte Tin-plated/Pb-free Solder Dipped                   |
| <b>Body Material</b>   | UL recognized epoxy meeting flammability classification 94V-0 |
| <b>Lead Material</b>   | Copper Alloy  |

### Design Considerations

Careful selection of the correct device for the application's operating parameters and environment will go a long way toward extending the operating life of the Thyristor. Good design practice should limit the maximum continuous current through the main terminals to 75% of the device rating. Other ways to ensure long life for a power discrete semiconductor are proper heat sinking and selection of voltage ratings for worst case conditions. Overheating, overvoltage (including dv/dt), and surge currents are the main killers of semiconductors. Correct mounting, soldering, and forming of the leads also help protect against component damage.

### Environmental Specifications

| Test                             | Specifications and Conditions   |
|----------------------------------|---|
| <b>AC Blocking</b>               | MIL-STD-750, M-1040, Cond A Applied Peak AC voltage @ 110°C for 1008 hours  |
| <b>Temperature Cycling</b>       | MIL-STD-750, M-1051, 100 cycles; -40°C to +150°C; 15-min dwell-time   |
| <b>Temperature/Humidity</b>      | EIA / JEDEC, JESD22-A101 1008 hours; 320V - DC; 85°C; 85% rel humidity  |
| <b>High Temp Storage</b>         | MIL-STD-750, M-1031, 1008 hours; 150°C  |
| <b>Low-Temp Storage</b>          | 1008 hours; -40°C   |
| <b>Thermal Shock</b>             | MIL-STD-750, M-1056 10 cycles; 0°C to 100°C; 5-min dwell-time at each temperature; 10 sec (max) transfer time between temperature |
| <b>Autoclave</b>                 | EIA / JEDEC, JESD22-A102 168 hours (121°C at 2 ATMs) and 100% R/H   |
| <b>Resistance to Solder Heat</b> | MIL-STD-750 Method 2031   |
| <b>Solderability</b>             | ANSI/J-STD-002, category 3, Test A  |
| <b>Lead Bend</b>                 | MIL-STD-750, M-2036 Cond E  |

**Dimensions – TO-92 (E Package)**



| Dimension | Inches |       | Millimeters |      |
|-----------|--------|-------|-------------|------|
|           | Min    | Max   | Min         | Max  |
| A         | 0.176  | 0.196 | 4.47        | 4.98 |
| B         | 0.500  | -     | 12.70       | -    |
| D         | 0.095  | 0.105 | 2.41        | 2.67 |
| E         | 0.150  | -     | 3.81        | -    |
| F         | 0.046  | 0.054 | 1.16        | 1.37 |
| G         | 0.135  | 0.145 | 3.43        | 3.68 |
| H         | 0.088  | 0.096 | 2.23        | 2.44 |
| J         | 0.176  | 0.186 | 4.47        | 4.73 |
| K         | 0.088  | 0.096 | 2.23        | 2.44 |
| L         | 0.013  | 0.019 | 0.33        | 0.48 |
| M         | 0.013  | 0.017 | 0.33        | 0.43 |

All leads insulated from case. Case is electrically nonconductive.

**Dimensions – Compak (C Package)**

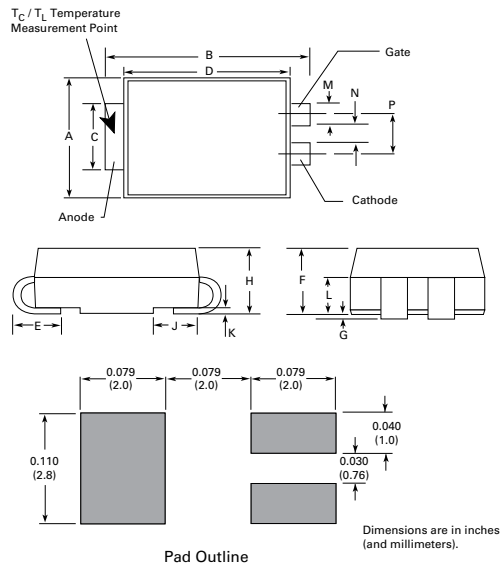

| Dimension | Inches |       | Millimeters |      |
|-----------|--------|-------|-------------|------|
|           | Min    | Max   | Min         | Max  |
| A         | 0.130  | 0.156 | 3.30        | 3.95 |
| B         | 0.201  | 0.220 | 5.10        | 5.60 |
| C         | 0.077  | 0.087 | 1.95        | 2.20 |
| D         | 0.159  | 0.181 | 4.05        | 4.60 |
| E         | 0.030  | 0.063 | 0.75        | 1.60 |
| F         | 0.075  | 0.096 | 1.90        | 2.45 |
| G         | 0.002  | 0.008 | 0.05        | 0.20 |
| H         | 0.077  | 0.104 | 1.95        | 2.65 |
| J         | 0.043  | 0.053 | 1.09        | 1.35 |
| K         | 0.006  | 0.016 | 0.15        | 0.41 |
| L         | 0.030  | 0.055 | 0.76        | 1.40 |
| M         | 0.022  | 0.028 | 0.56        | 0.71 |
| N         | 0.027  | 0.033 | 0.69        | 0.84 |
| P         | 0.052  | 0.058 | 1.32        | 1.47 |

Dimensions are in inches (and millimeters).

**Product Selector**

| Part Number | Voltage    |      |      |       | Gate Sensitivity | Type          | Package |
|-------------|------------|------|------|-------|------------------|---------------|---------|
|             | 400V       | 600V | 800V | 1000V |                  |               |         |
| EC103 x 1   | X          | X    |      |       | 12μA             | Sensitive SCR | TO-92   |
| EC103 x 2   | X          | X    |      |       | 50μA             | Sensitive SCR | TO-92   |
| EC103 x     | X / 2N6565 | X    |      |       | 200μA            | Sensitive SCR | TO-92   |
| EC103 x 3   | X          | X    |      |       | 500μA            | Sensitive SCR | TO-92   |
| S x S1      | X          | X    |      |       | 12μA             | Sensitive SCR | Compak  |
| S x S2      | X          | X    |      |       | 50μA             | Sensitive SCR | Compak  |
| S x S       | X          | X    |      |       | 200μA            | Sensitive SCR | Compak  |
| S x S3      | X          | X    |      |       | 500μA            | Sensitive SCR | Compak  |

Note: x = Voltage

**Packing Options**

| Part Number      | Marking          | Weight | Packing Mode     | Base Quantity |
|------------------|------------------|--------|------------------|---------------|
| EC103xy / 2N6565 | EC103xy / 2N6565 | 0.19 g | Bulk             | 2000          |
| EC103xyRP        | EC103xy          | 0.19 g | Reel Pack        | 2000          |
| EC103xyAP        | EC103xy          | 0.19 g | Ammo Pack        | 2000          |
| SxSyRP           | SxSy             | 0.08 g | Embossed Carrier | 2500          |

Note: x = Voltage, y = sensitivity

**TO-92 (3-lead) Reel Pack (RP) Radial Leaded Specifications**

**Meets all EIA-468-C Standards**

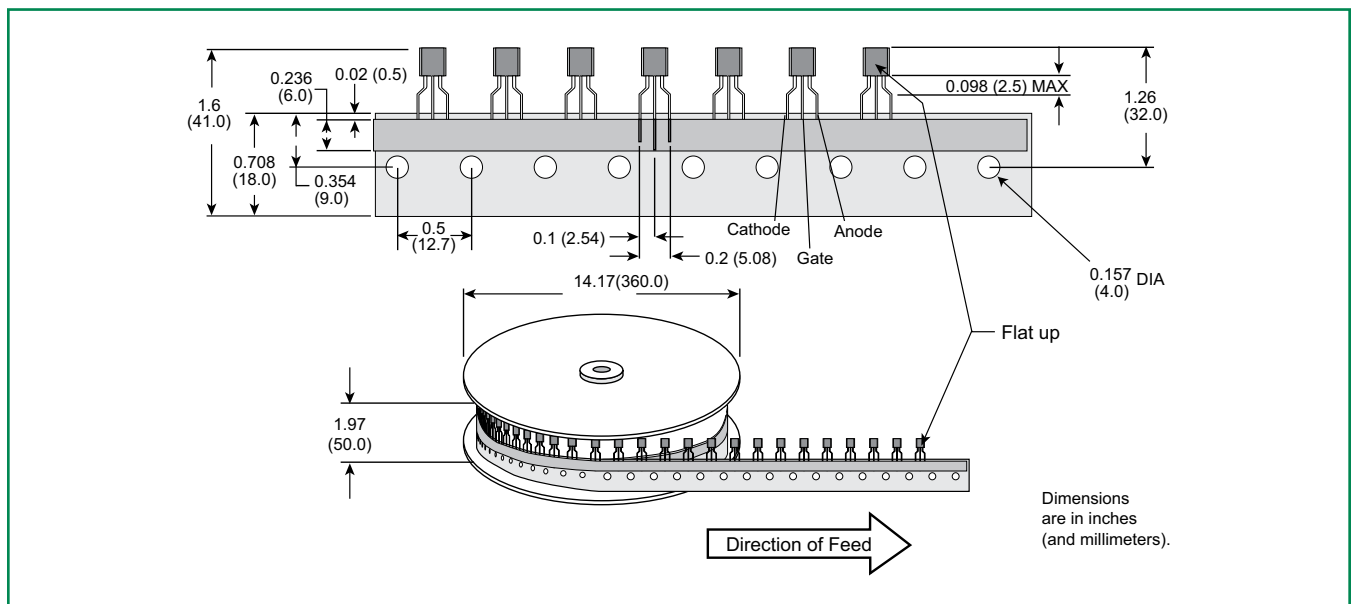



**TO-92 (3-lead) Ammo Pack (AP) Radial Leaded Specifications**

Meets all EIA-468-C Standards



**Compak Embossed Carrier Reel Pack (RP) Specifications**

Meets all EIA-481-1 Standards



**Part Numbering System (TO-92)**



**Part Marking System**

**TO-92 (E Package)**



**Date Code Marking**  
Y: Year Code  
M: Month Code  
L: Location Code  
XX: Lot Serial Code

**Part Numbering System (Compak)**



**Part Marking System (Compak)**

**Compak (C Package)**

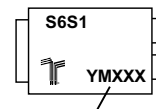

**Date Code Marking**  
Y: Year Code  
M: Month Code  
XXX: Lot Trace Code