

Product Description

Qorvo's QPA1011 is a X-band high power MMIC amplifier fabricated on Qorvo's production 0.15um GaN on SiC process (QGaN15). The QPA1011 operates from 7.9 – 11 GHz and typically provides 25 W saturated output power with power-added efficiency of 37.5% and large-signal gain of 19.5 dB. This combination of wideband performance provides the flexibility designers are looking for to improve system performance while reducing size and cost.

QPA1011 can also support a variety of operating conditions to best support system requirements. With good thermal properties, it can support a range of bias voltages and will perform well under both CW and pulse operations.

The QPA1011 is matched to 50Ω with integrated DC blocking capacitors on both RF I/O ports simplifying system integration. The wideband performance and operational flexibility allows it support satellite communication and data links, as well as, military and commercial radar systems.

Lead-free and RoHS compliant.

Evaluation boards are available upon request.

Functional Block Diagram

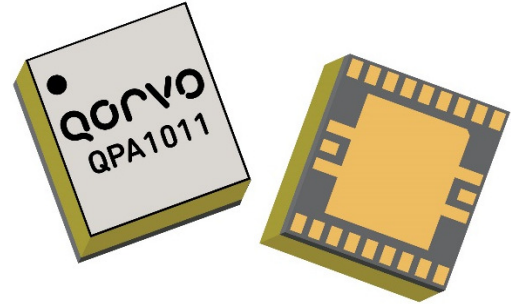
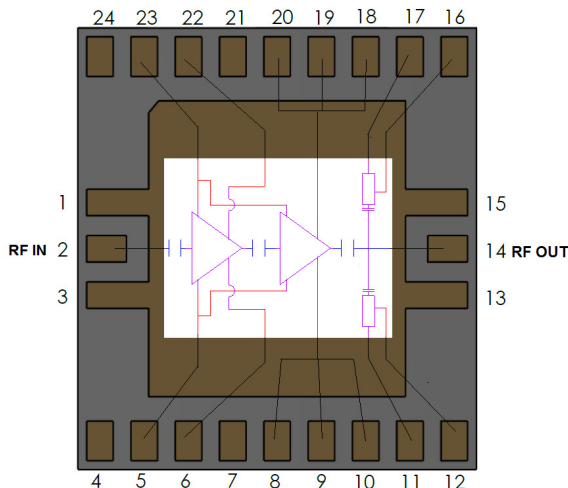

Product Features

- Frequency Range: 7.9–11 GHz
- P_{OUT}: 44.5 dBm at P_{IN} = 25 dBm
- PAE: 37.5% at P_{IN} = 25 dBm
- Large Signal Gain: 19.5 dB at P_{IN} = 25 dBm
- Small Signal Gain: 26 dB
- Integrated Power Detector
- Bias: V_D = 24 V, I_{DQ} = 1200 mA, V_G = -1.9 V Typical
- Pulsed V_D: PW = 100 μS, DC = 10%
- Package Dimensions: 4.5 x 5.0 x 1.72 mm

Performance is typical across frequency. Please reference electrical specification table and data plots for more details.

Applications

- Satellite Communications
- Data Links
- Military and Commercial Radar

Ordering Information

Part No.	ECCN	Description
QPA1011	3A001.b.2.b.2	7.9–11 GHz 25 W GaN Power Amplifier

Absolute Maximum Ratings

Parameter	Value / Range
Drain Voltage (V_D)	29.5 V
Gate Voltage Range (V_G)	-8 to 0V
Drain Current (I_{D1}/I_{D2})	672 mA / 2880 mA
Gate Current (I_G)	See chart, pg. 21
Power Dissipation (P_{DISS}), 85 °C, CW	70 W
Input Power (P_{IN}), CW, 50Ω, $V_D=28$ V, $I_{DQ}=1200$ mA, 85 °C	30 dBm
Input Power (P_{IN}), CW, VSWR 3:1, $V_D=28$ V, $I_{DQ}=1200$ mA 85 °C	30 dBm
Channel Temperature (T_{CH})	275 °C
Mounting Temperature (30 seconds)	260 °C
Storage Temperature	-55 to 150 °C

Operation of this device outside the parameter ranges given above may cause permanent damage. These are stress ratings only, and functional operation of the device at these conditions is not implied.

Electrical Specifications

Parameter		Min	Typ	Max	Units
Operational Frequency Range		7.9		11	GHz
Output Power ($P_{IN} = 25$ dBm)	7.9 GHz		44.2		dBm
	9.0 GHz		45.0		dBm
	11.0 GHz		44.8		dBm
Power Added Efficiency ($P_{IN} = 25$ dBm)	7.9 GHz		35.6		%
	9.0 GHz		38.7		%
	11.0 GHz		39.4		%
3 rd Order Intermodulation Level ($P_{OUT}/Tone= 38$ dBm)	7.9 GHz		-20.0		dBc
	10.0 GHz		-21.2		dBc
	11.0 GHz		-21.5		dBc
Small Signal Gain	7.9 GHz		29.0		dB
	9.0 GHz		28.8		dB
	11.0 GHz		28.0		dB
Input Return Loss	7.9 GHz		13.5		dB
	9.0 GHz		30.0		dB
	11.0 GHz		17.5		dB
Output Return Loss	7.9 GHz		9.0		dB
	9.0 GHz		10.0		dB
	11.0 GHz		16.0		dB
Output Power Temperature Coefficient (25–85 °C) ($P_{IN} = 25$ dBm)			-0.006		dB/°C
Small Signal Gain Temperature Coefficient (25–85 °C)			-0.053		dB/°C
Recommended Voltage Operations			24	28	V

Test conditions, unless otherwise noted: 25 °C, Pulsed V_D : PW = 100 μS, DC = 10%, $V_D = 24$ V, $I_{DQ} = 1200$ mA, $V_G = -1.9$ V Typical

Recommended Operating Conditions

Parameter	Value / Range
Drain Voltage (V_D)	24 V
Drain Current (I_{DQ})	1200 mA
Gate Voltage (V_G), Typical	-1.9 V

Electrical specifications are measured at specified test conditions. Specifications are not guaranteed over all recommended operating conditions.

Performance Plots – Large Signal (Pulsed)

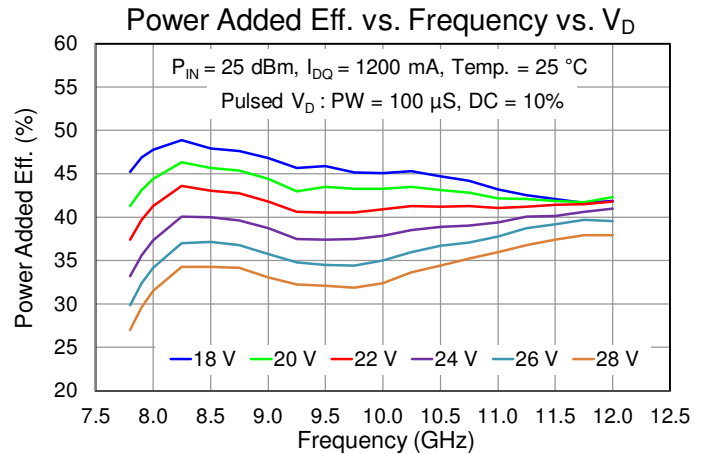
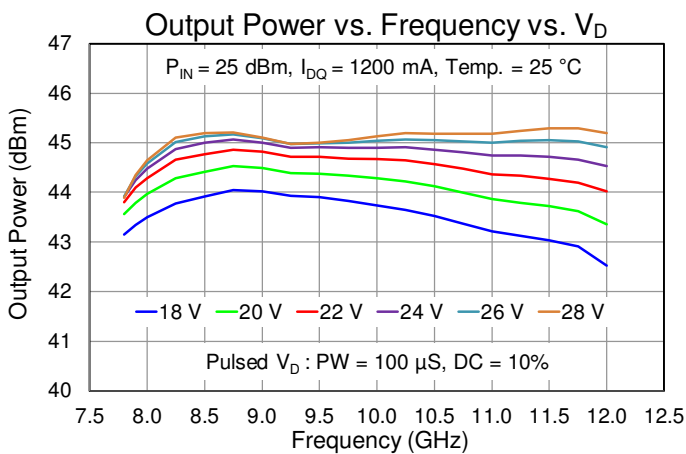
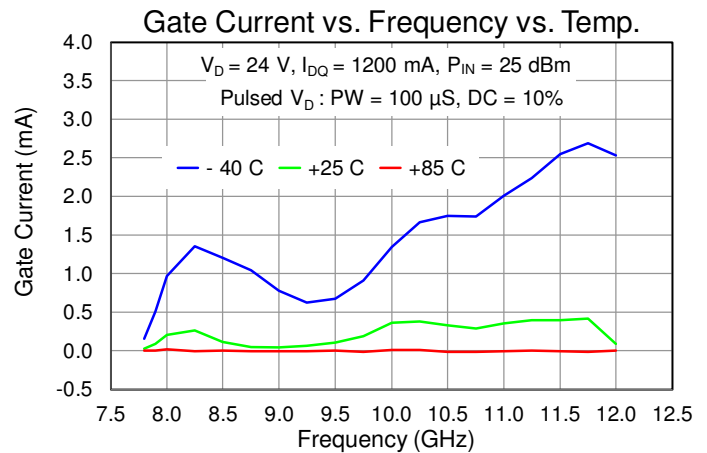
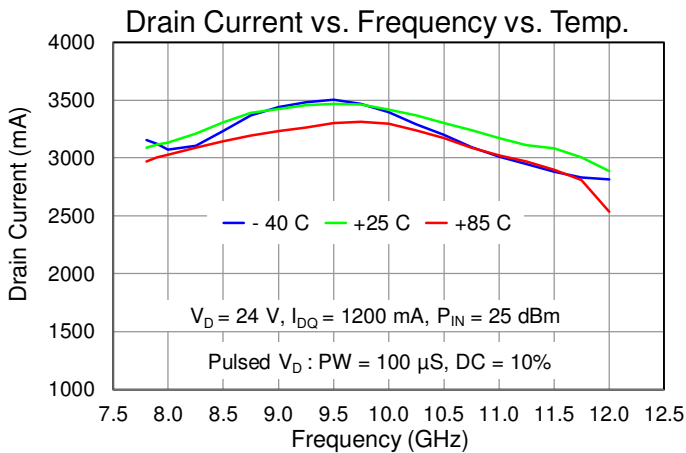
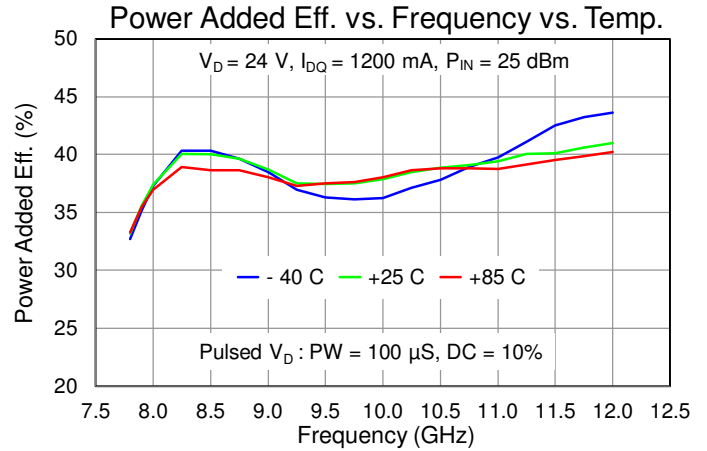
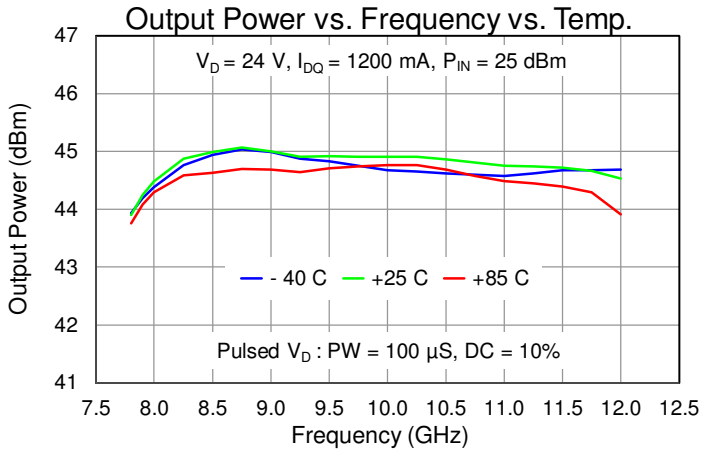

Performance Plots – Large Signal (Pulsed)

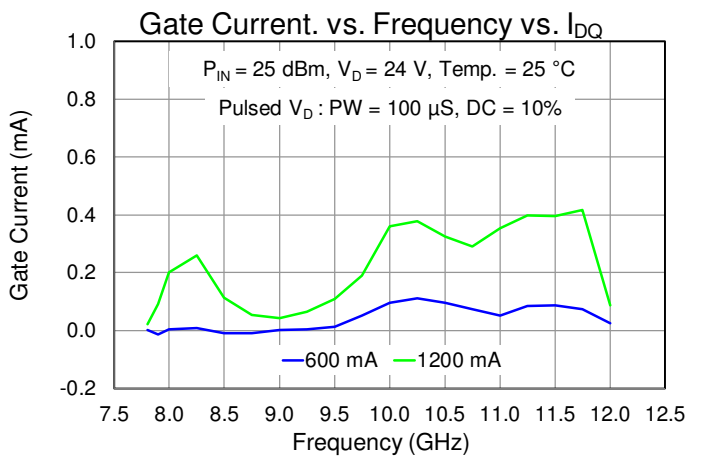
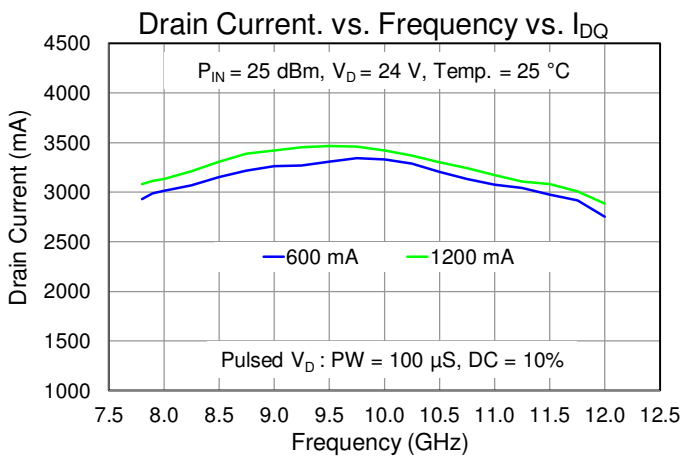
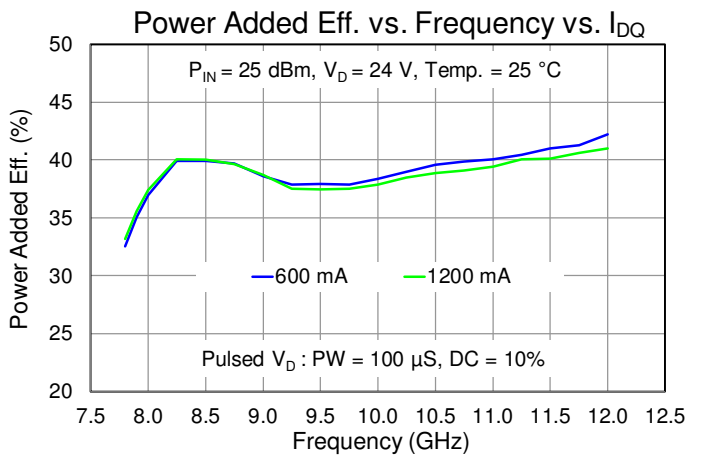
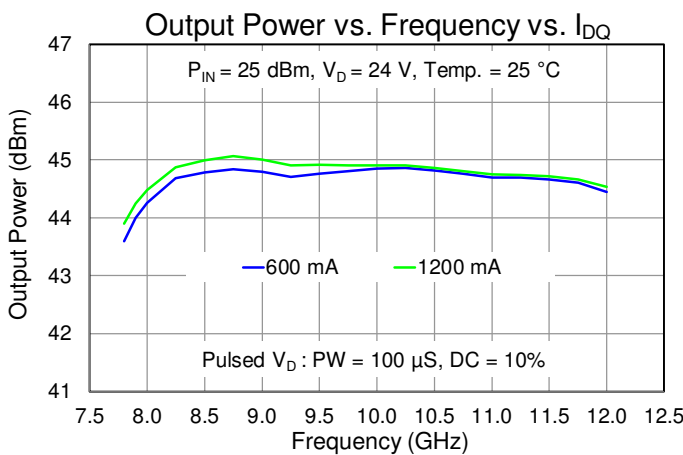
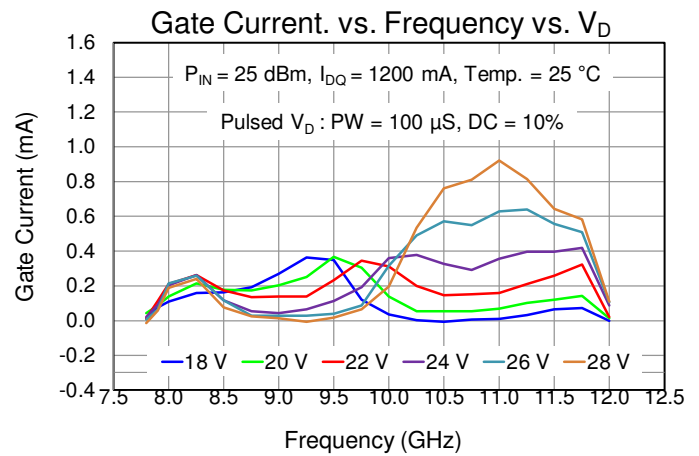
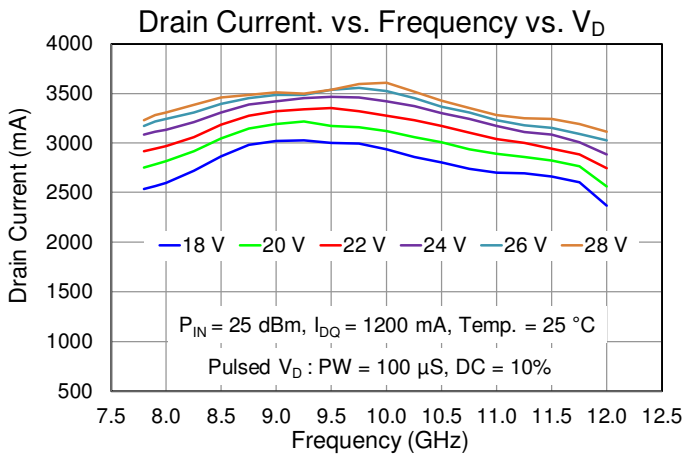

Performance Plots – Large Signal (Pulsed)

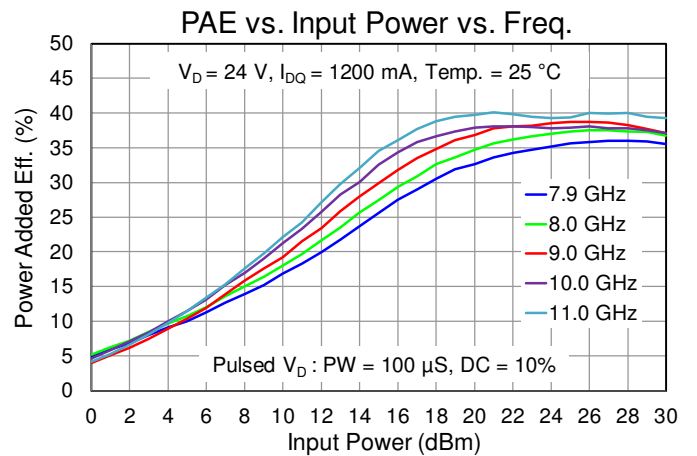
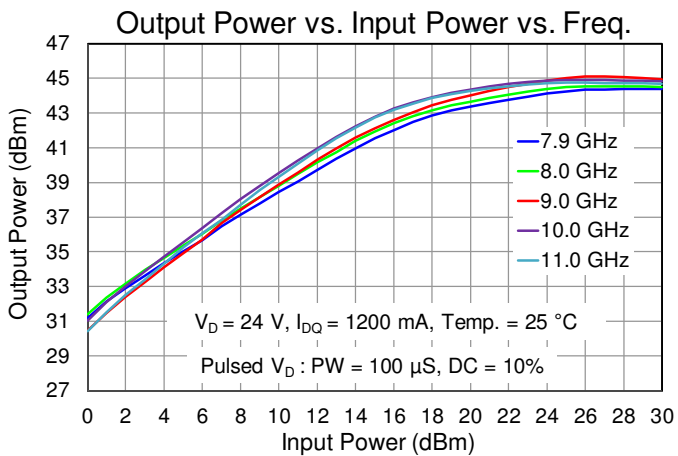
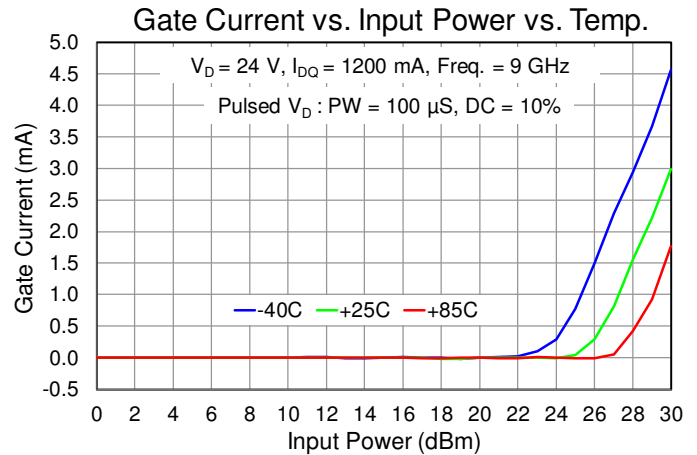
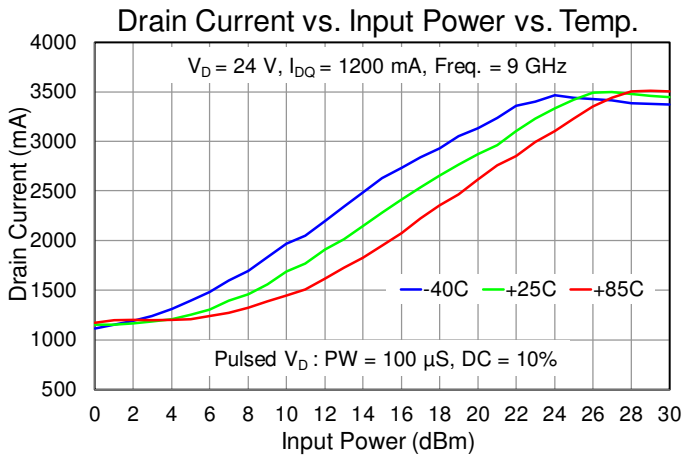
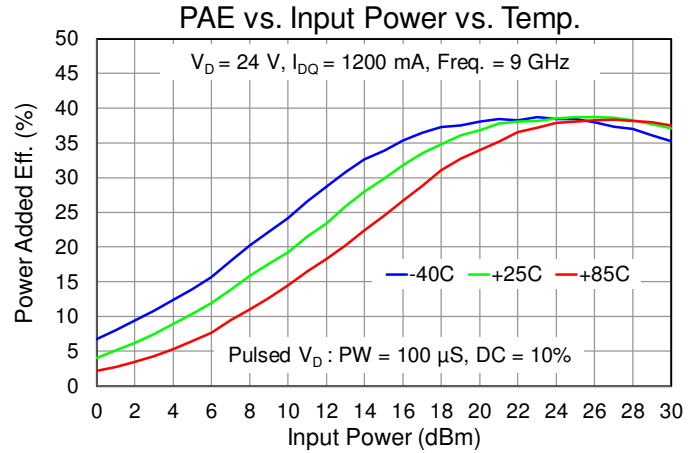
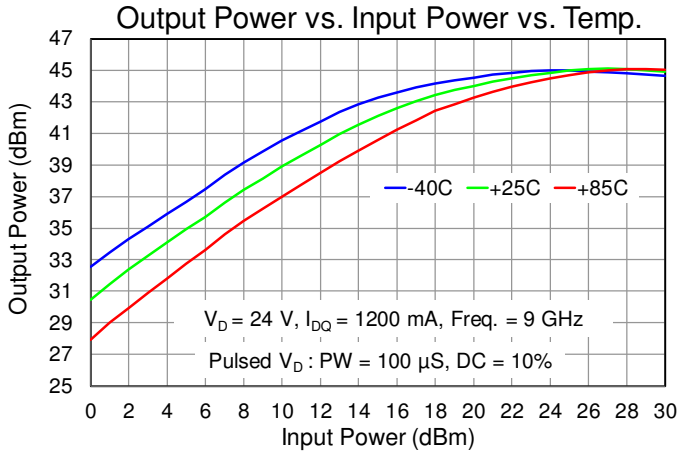

Performance Plots – Large Signal (Pulsed)

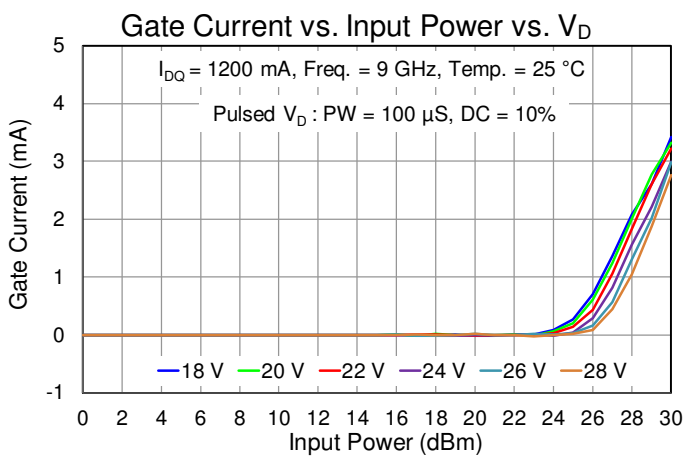
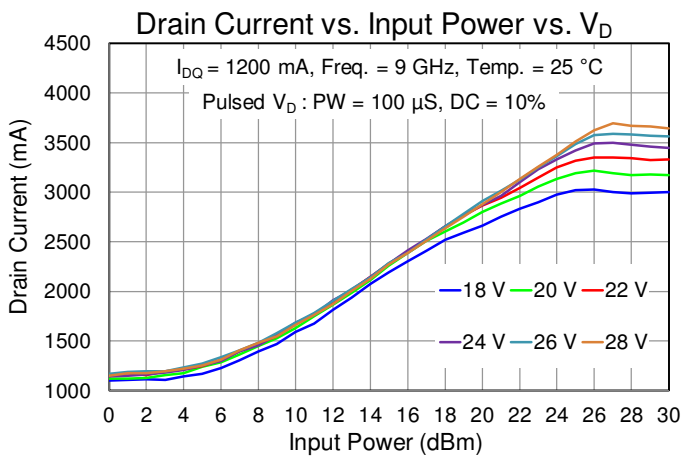
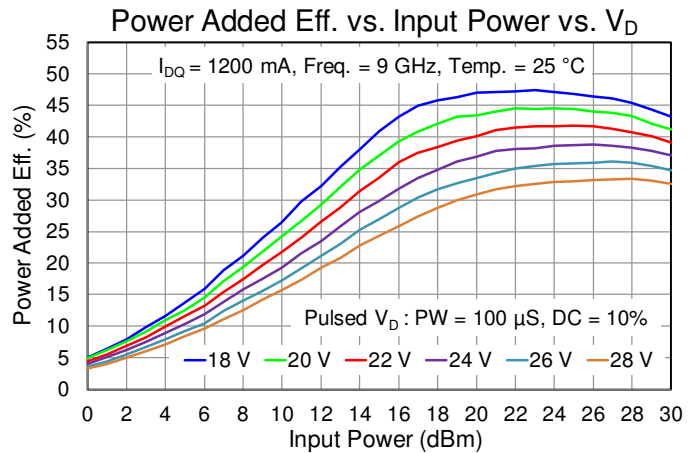
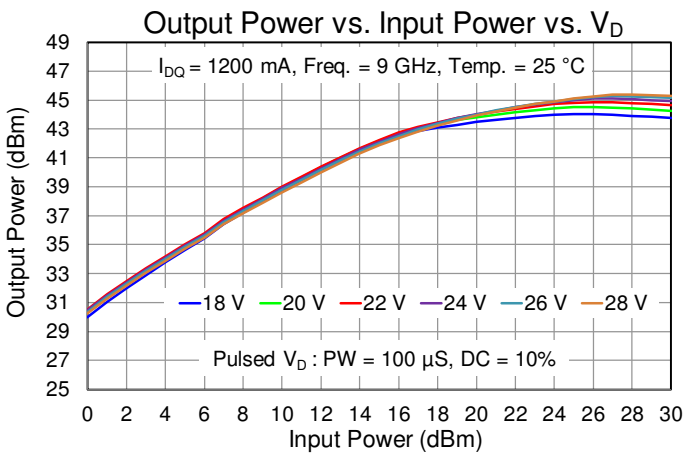
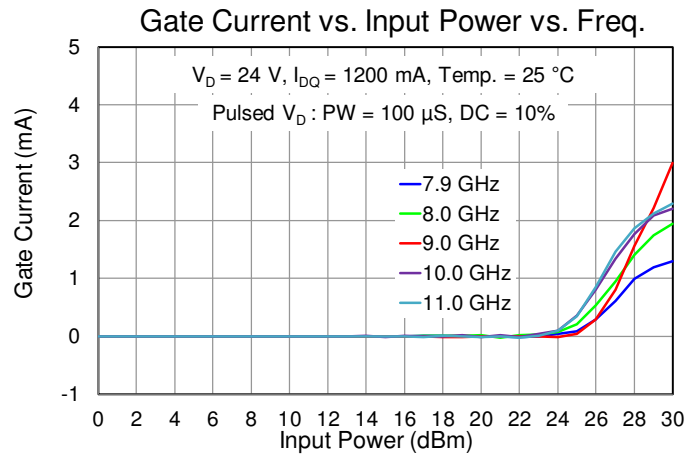
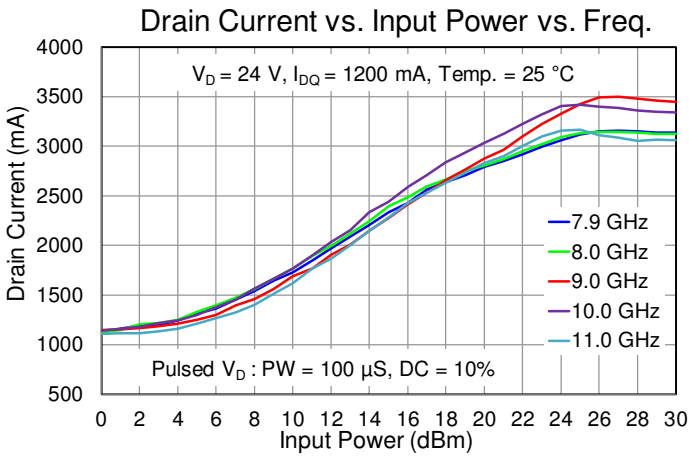

Performance Plots – Large Signal (CW)

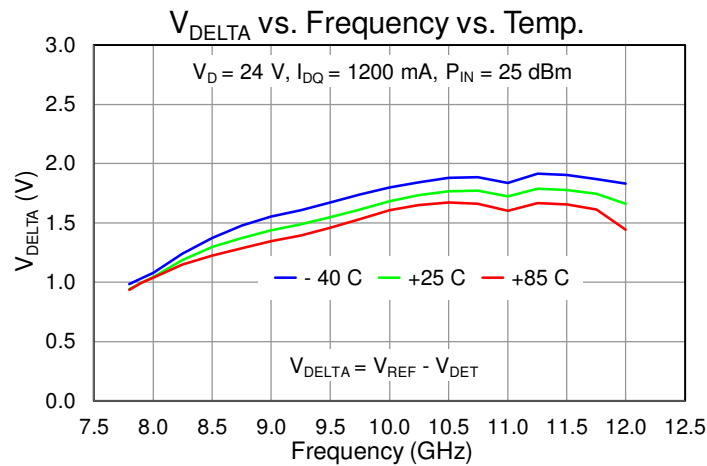
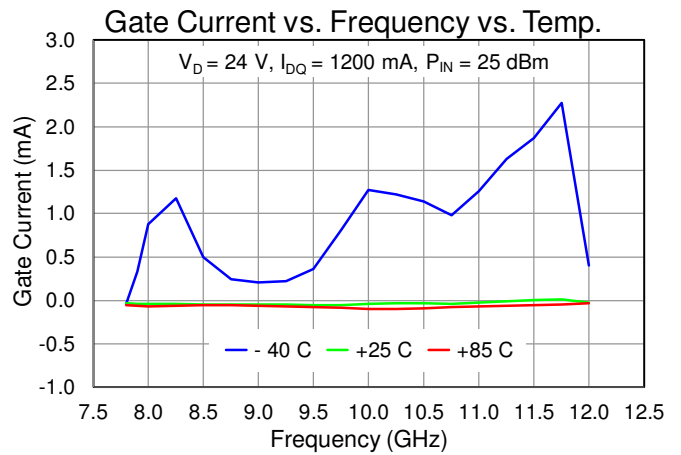
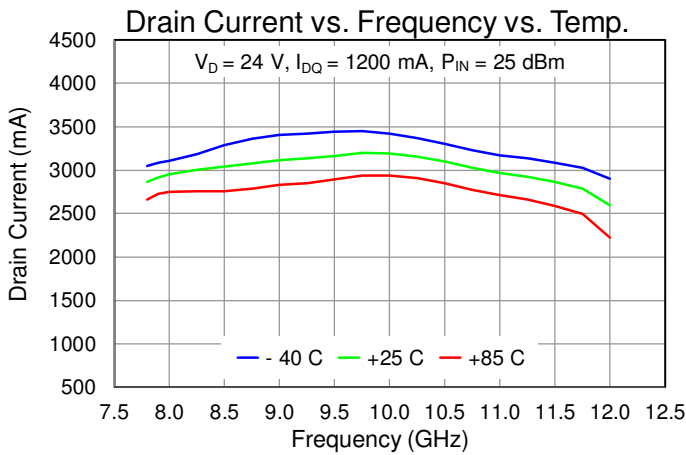
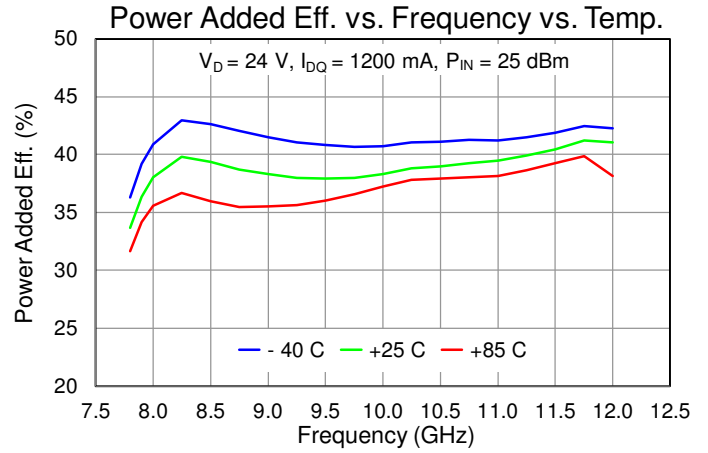
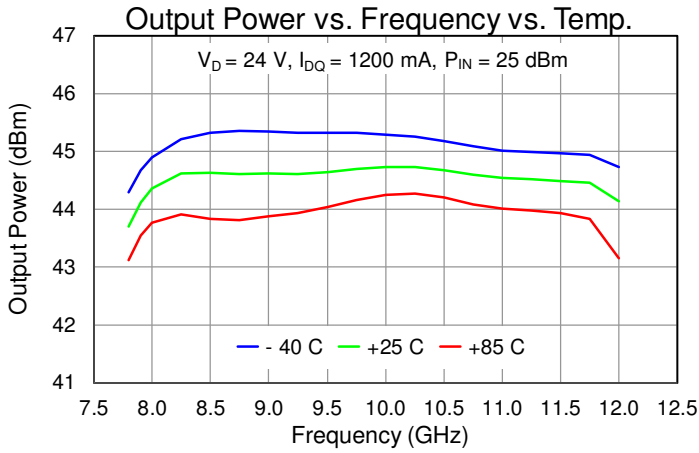

Performance Plots – Large Signal (CW)

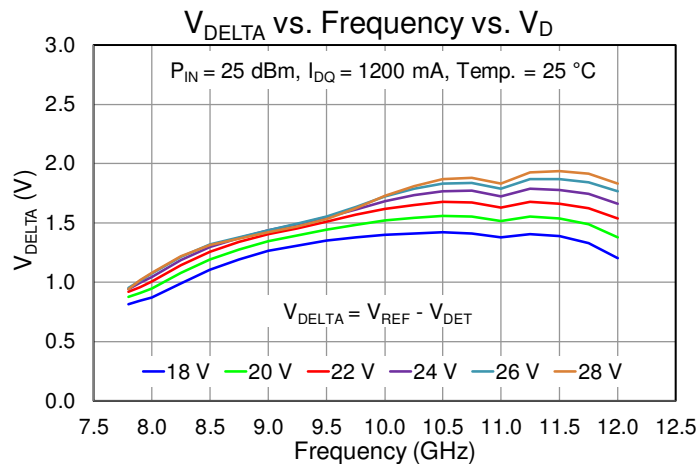
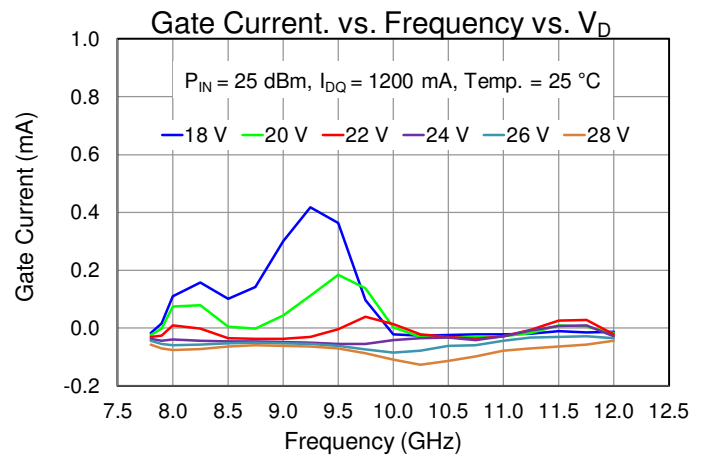
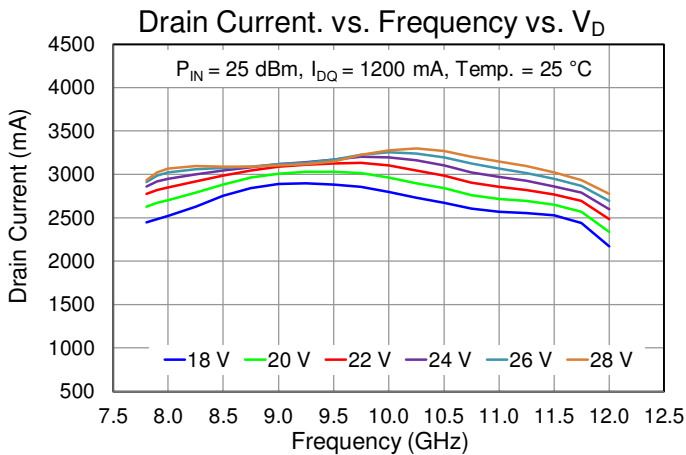
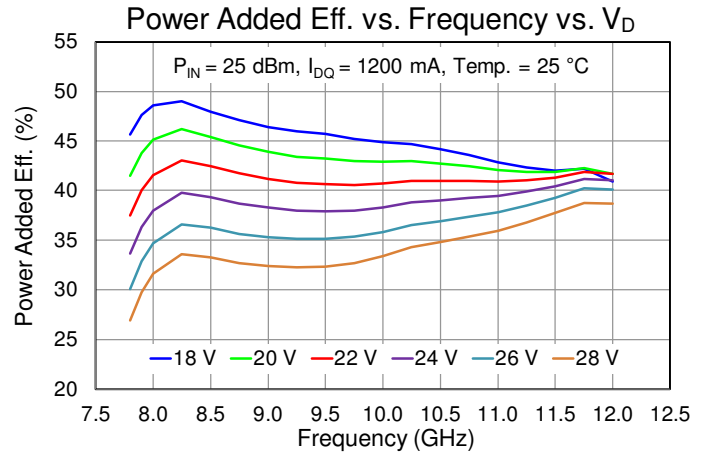
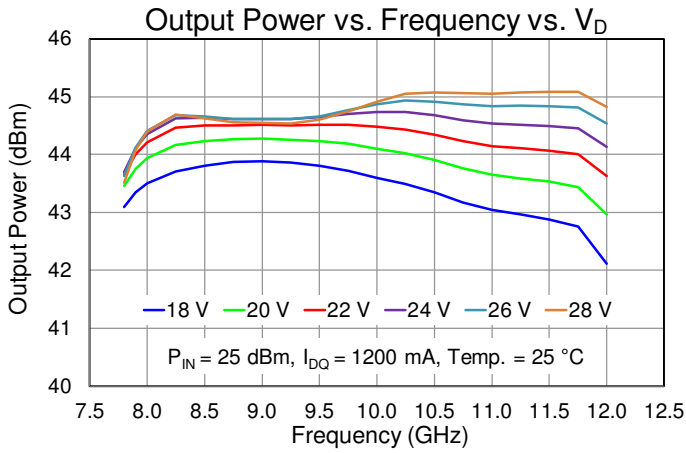

Performance Plots – Large Signal (CW)

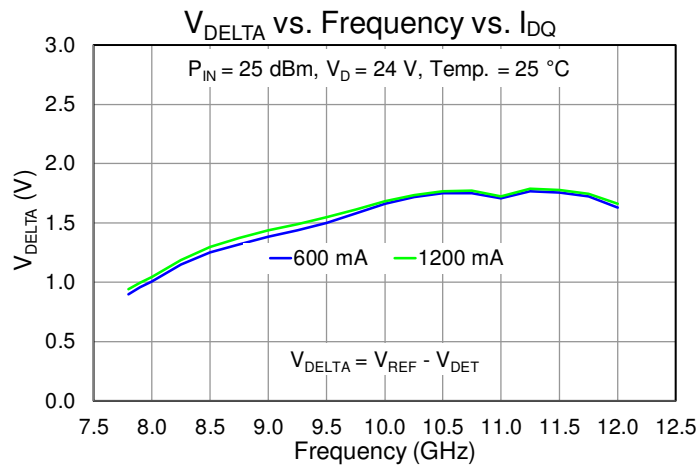
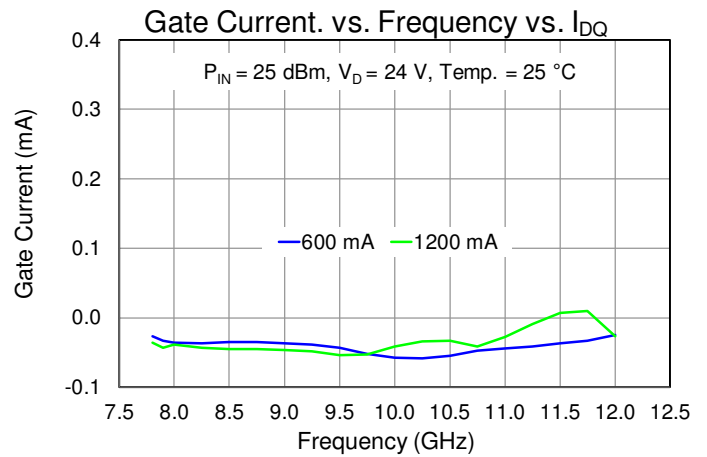
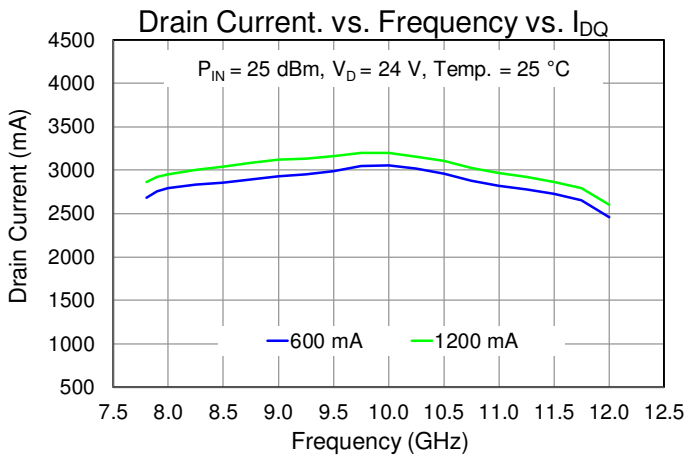
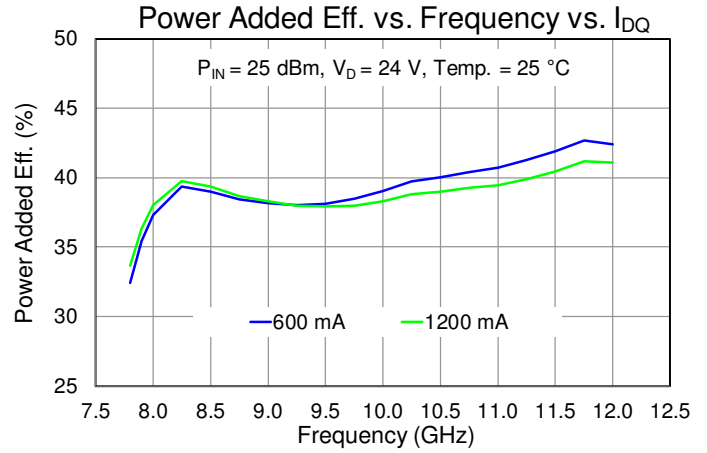
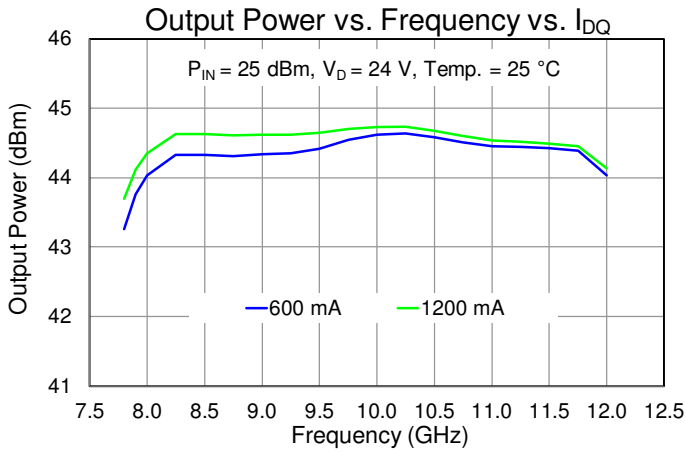

Performance Plots – Large Signal (CW)

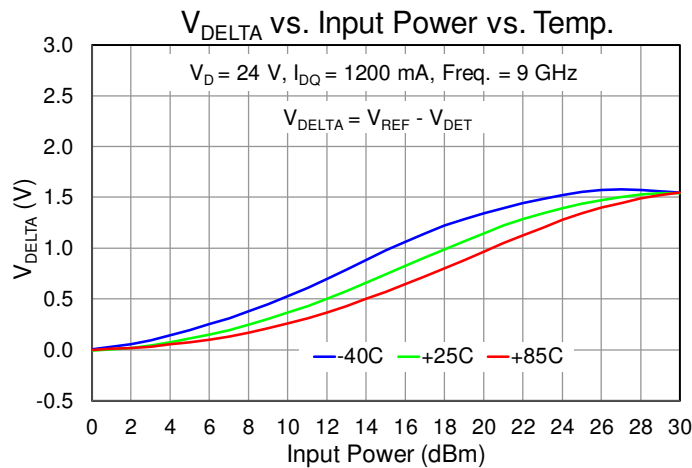
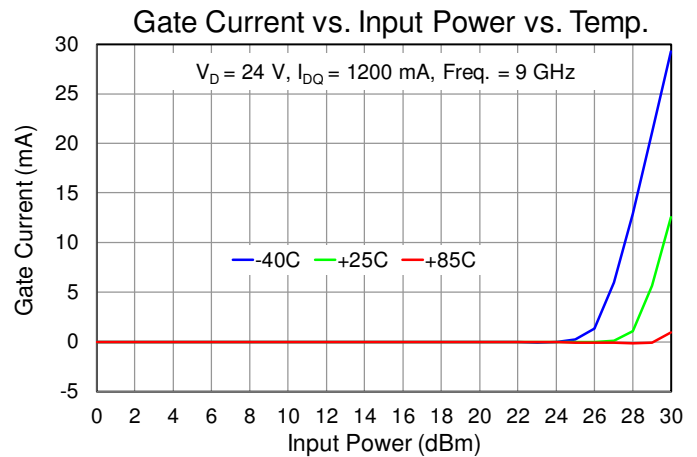
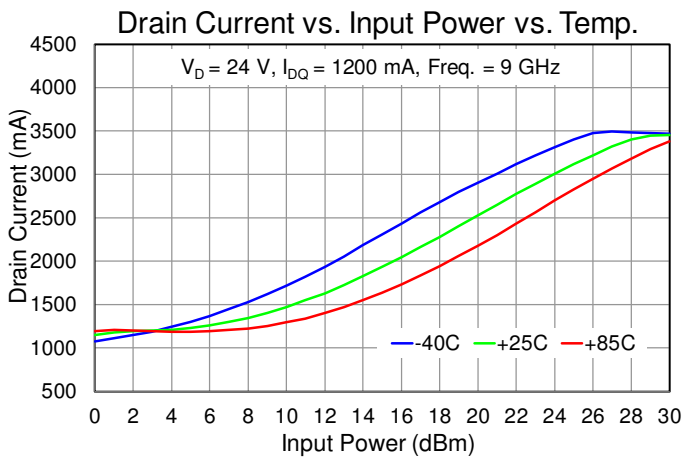
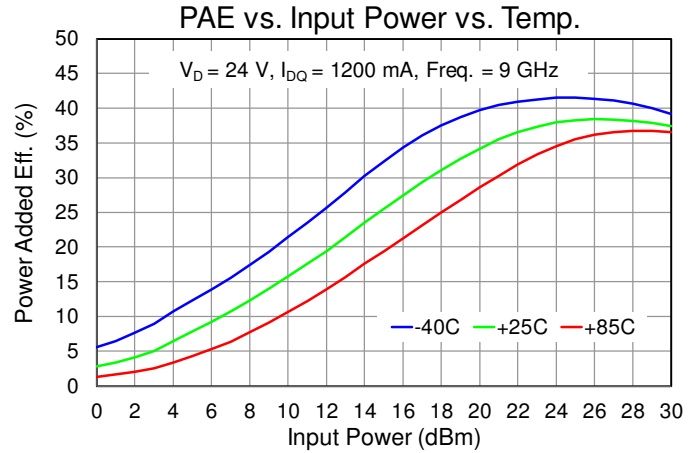
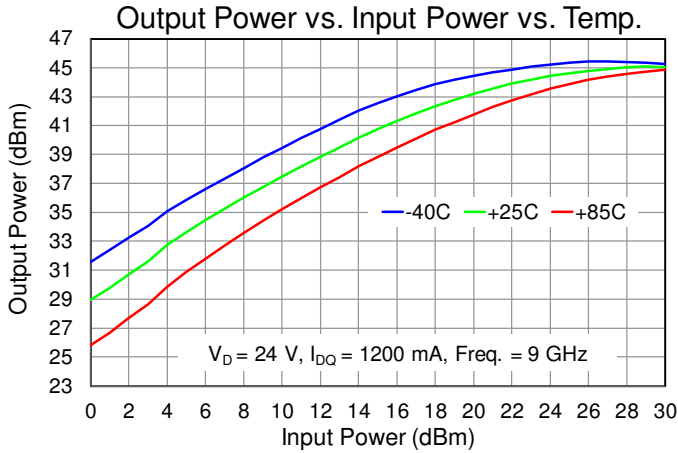

Performance Plots – Large Signal (CW)

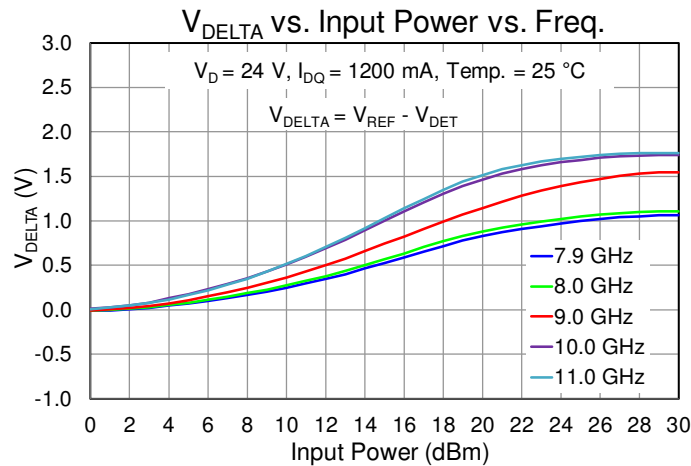
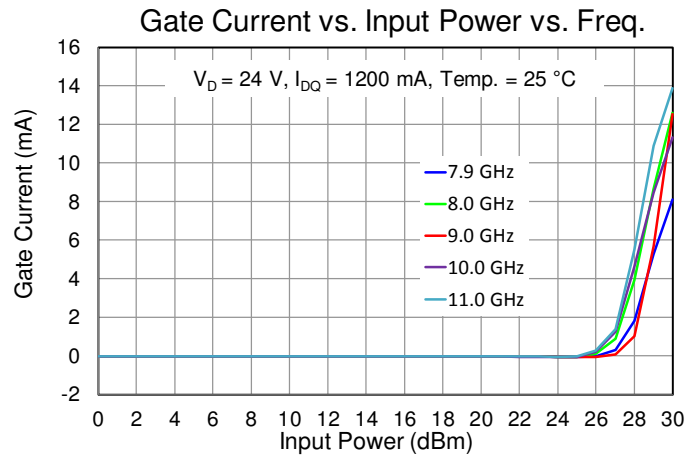
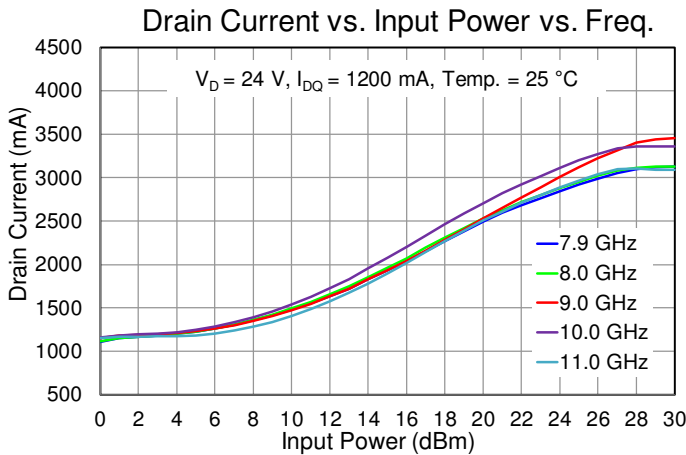
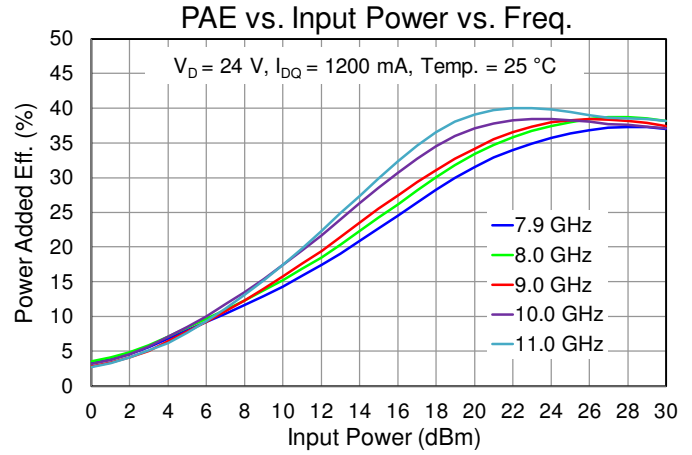
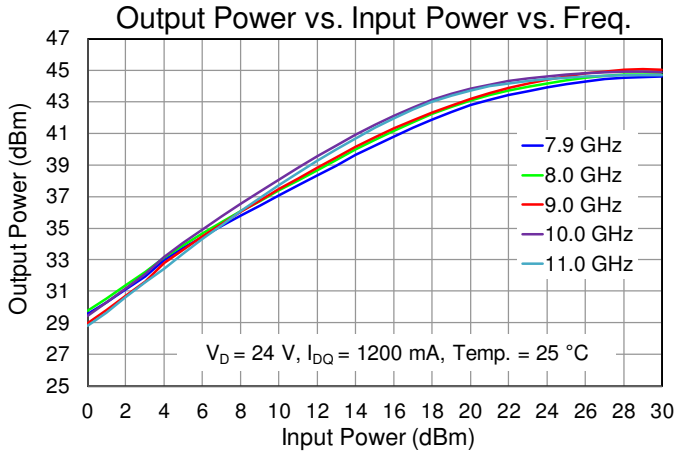

Performance Plots – Large Signal (CW)

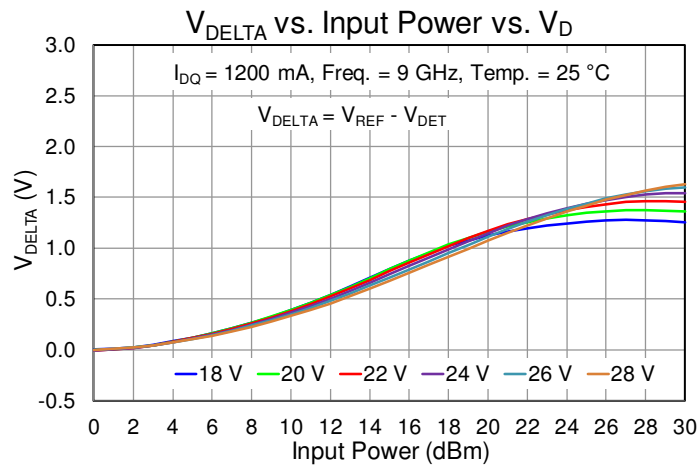
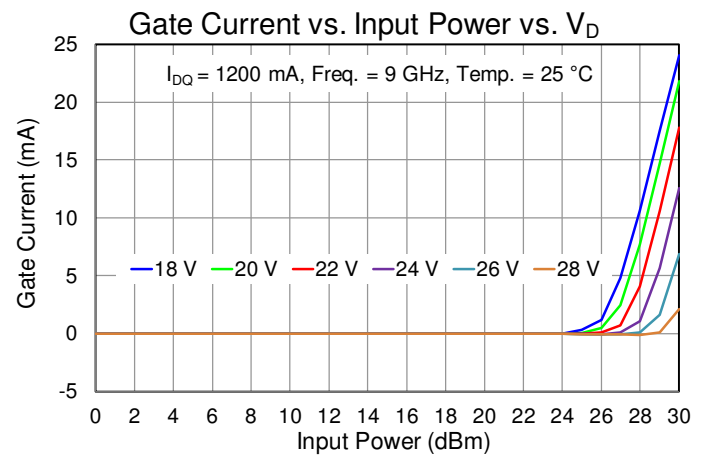
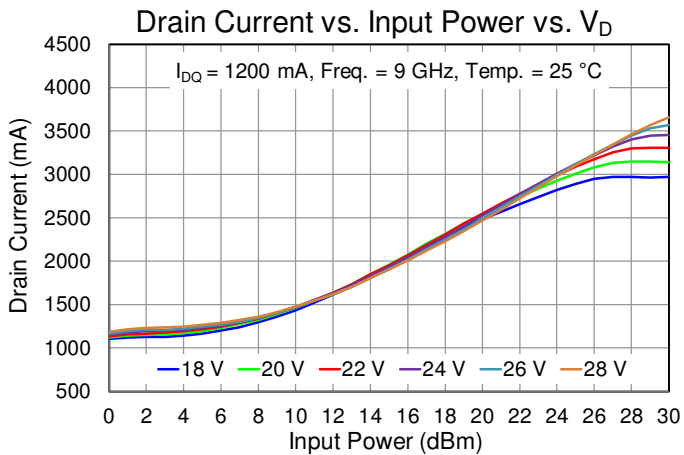
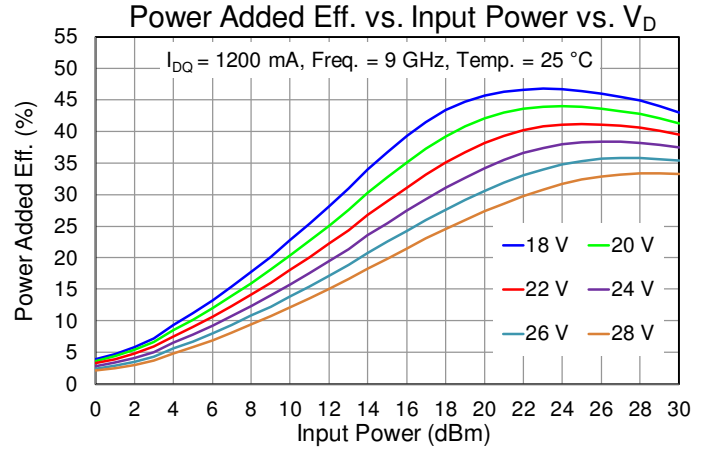
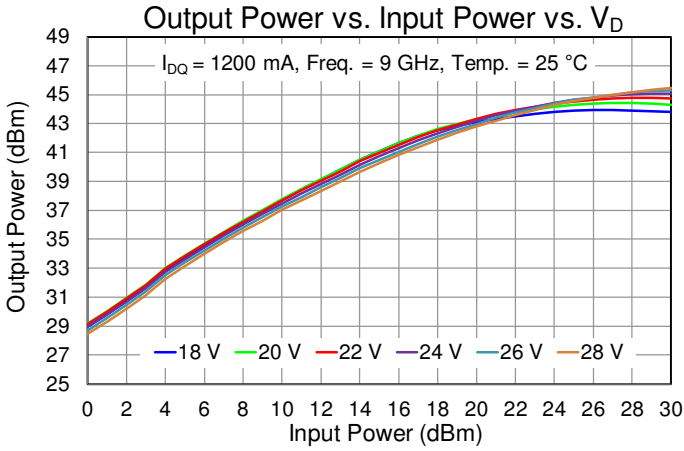

Performance Plots – Linearity

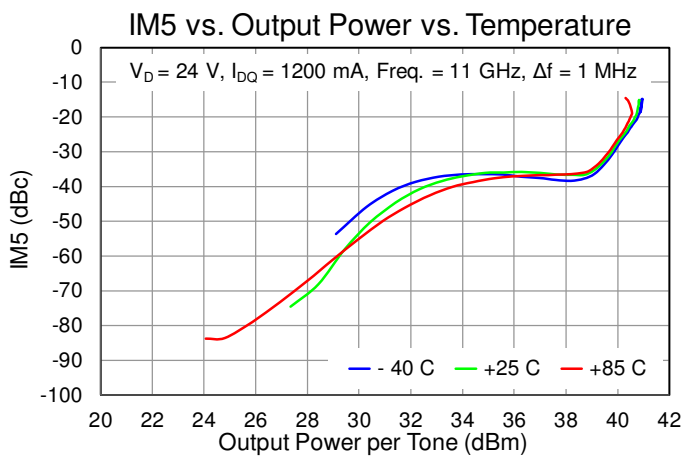
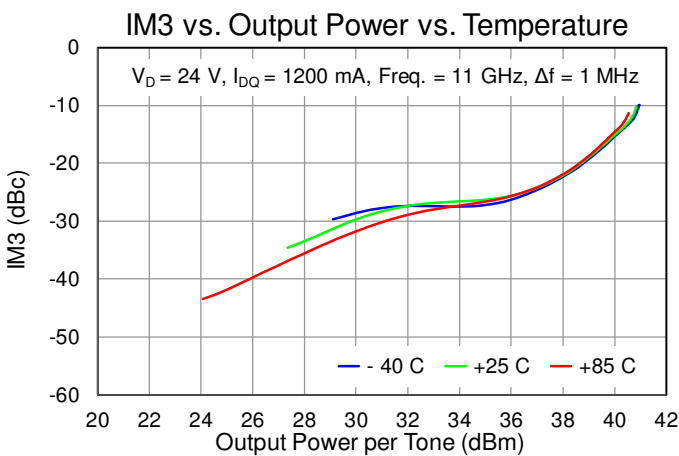
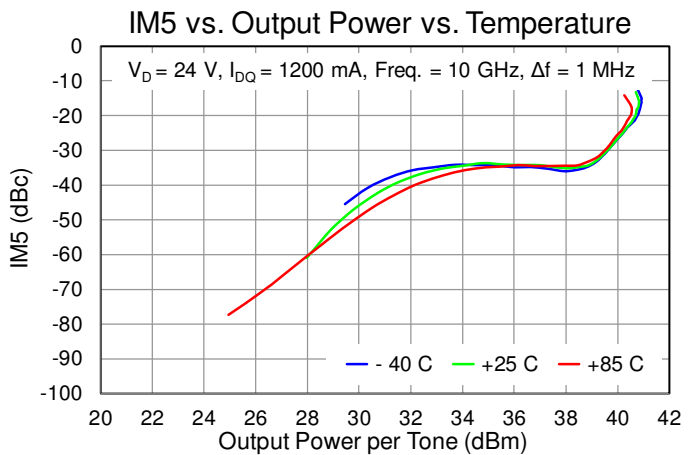
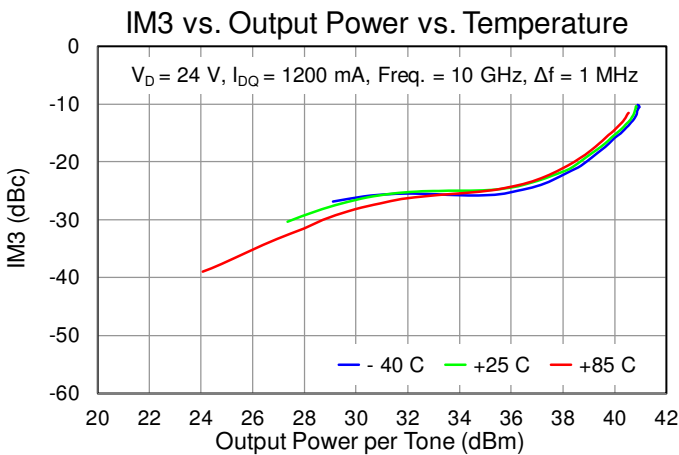
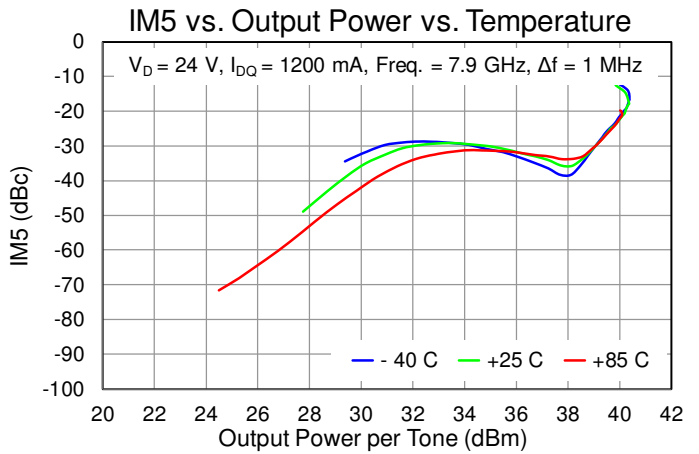
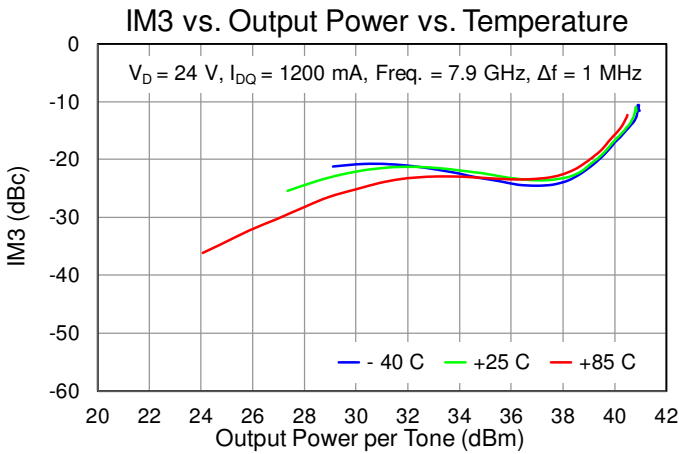

Performance Plots – Linearity

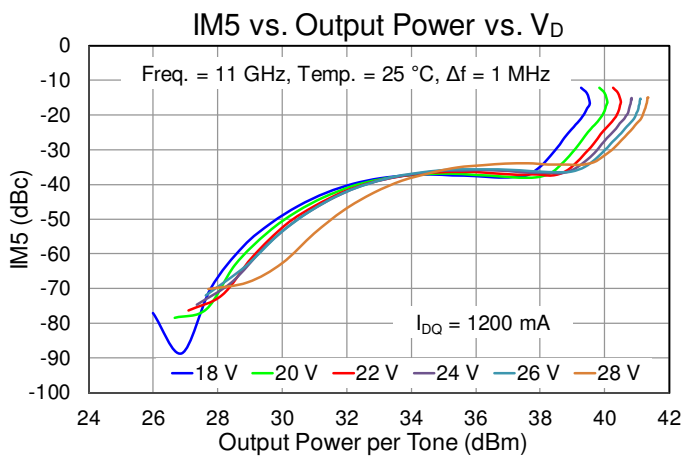
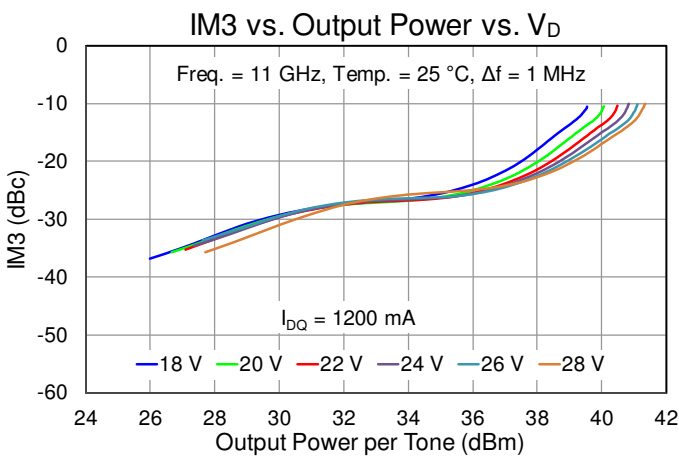
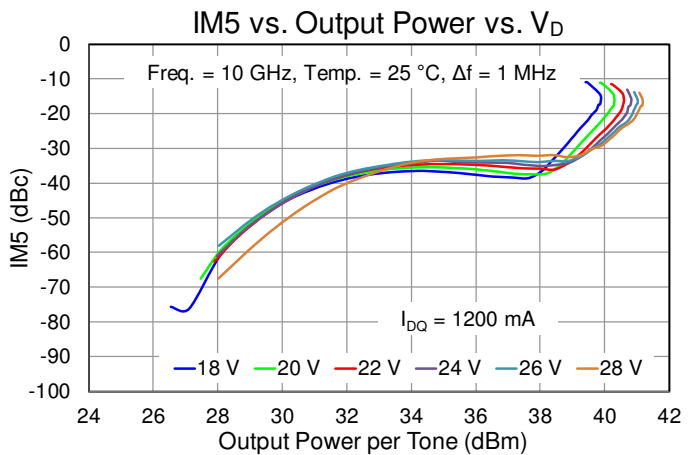
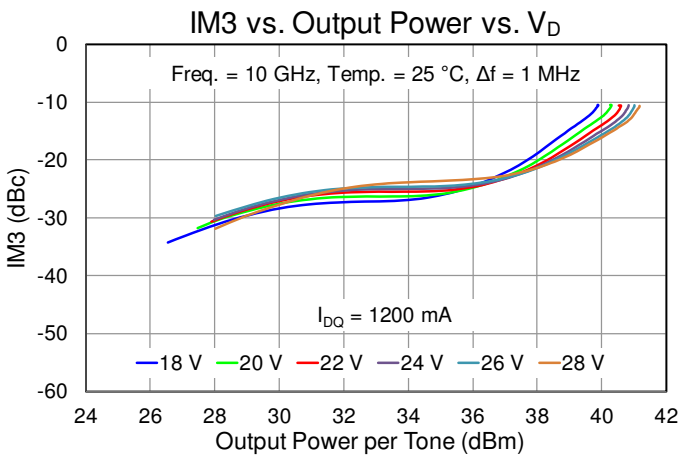
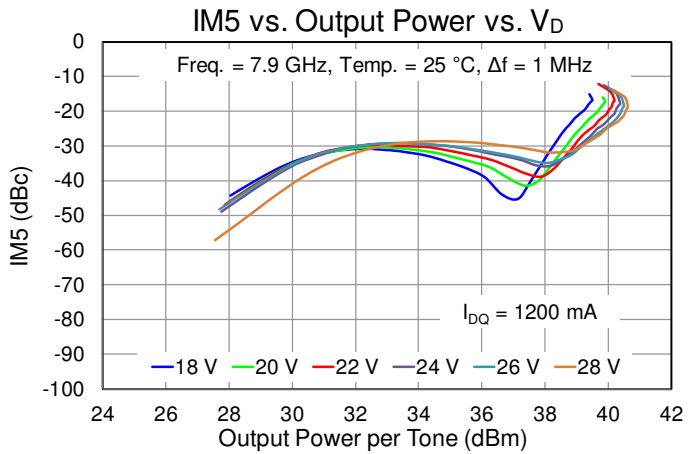
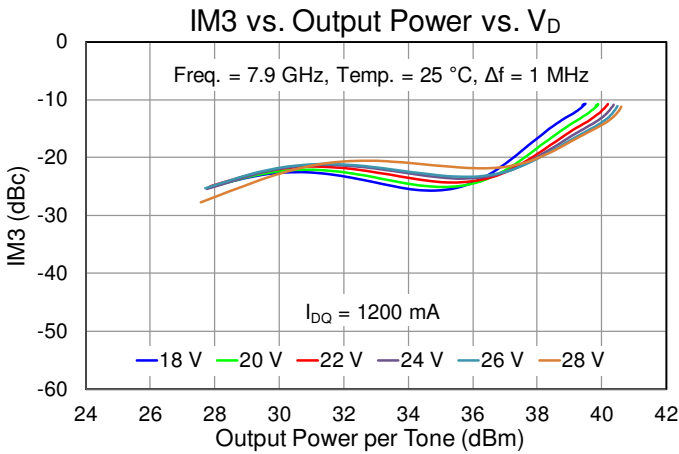

Performance Plots – Linearity

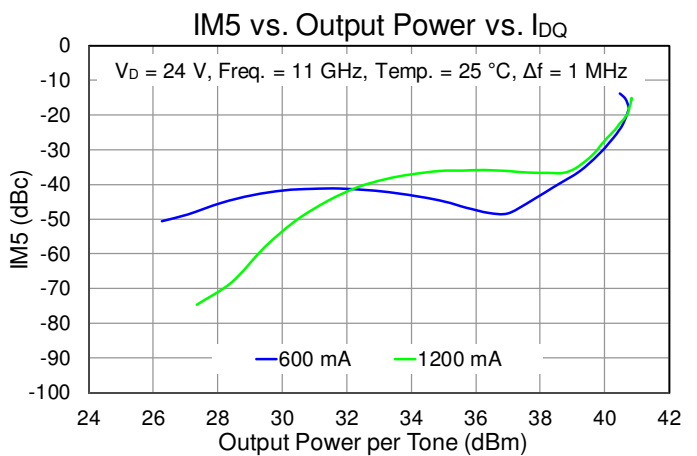
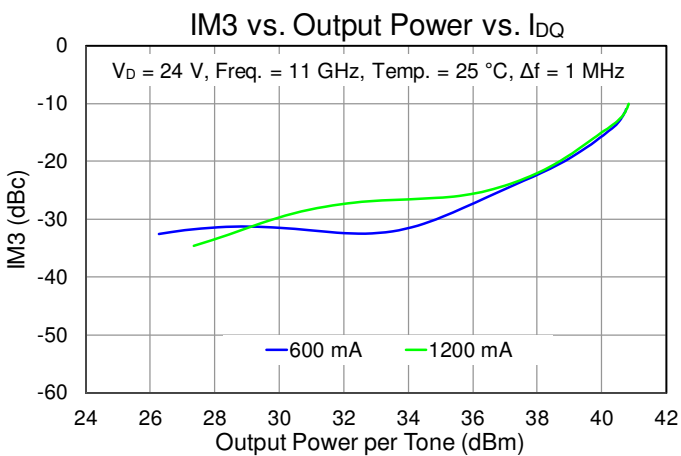
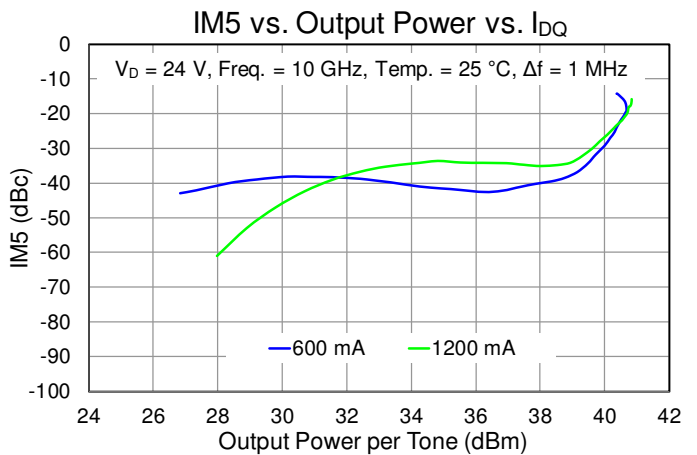
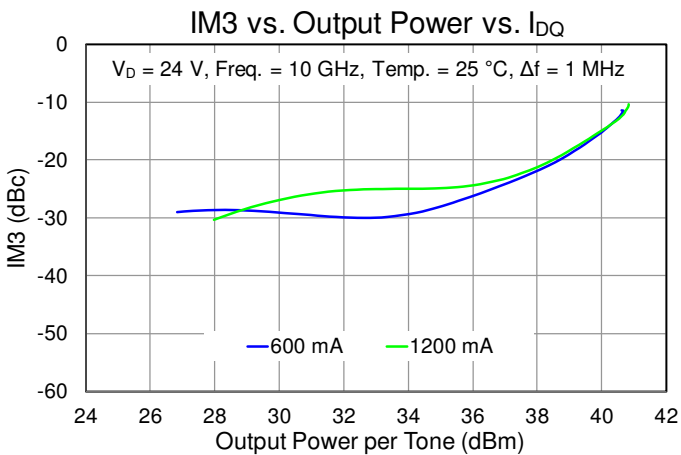
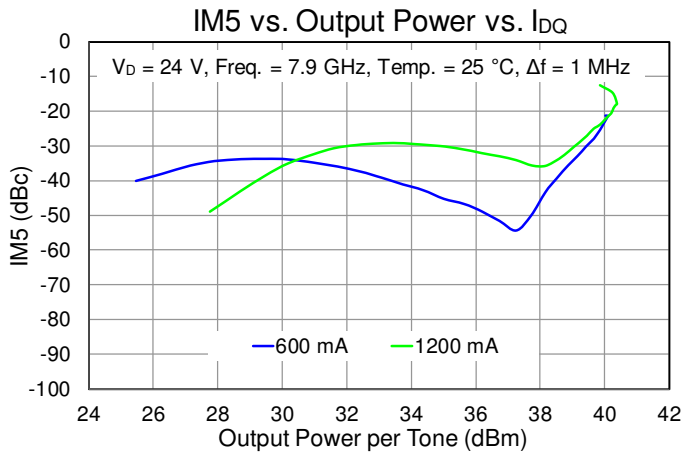
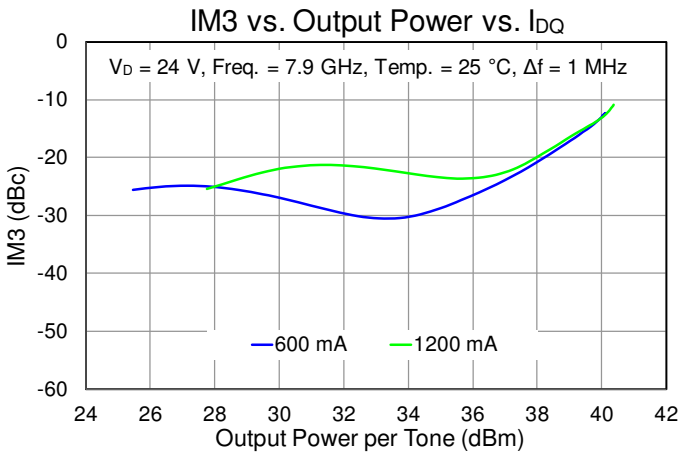

Performance Plots – Linearity

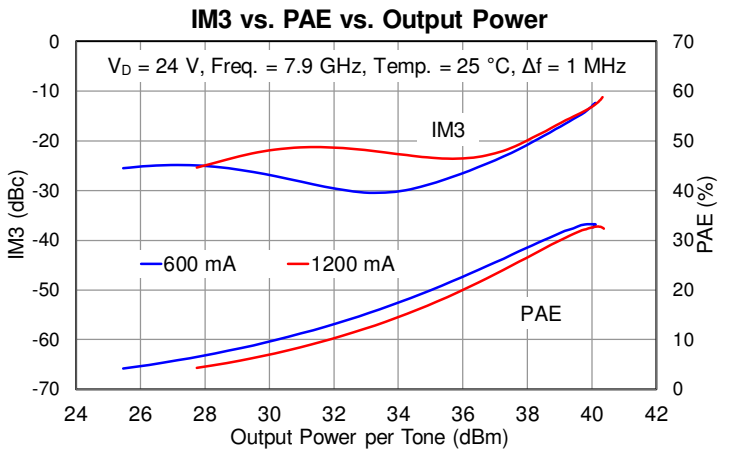
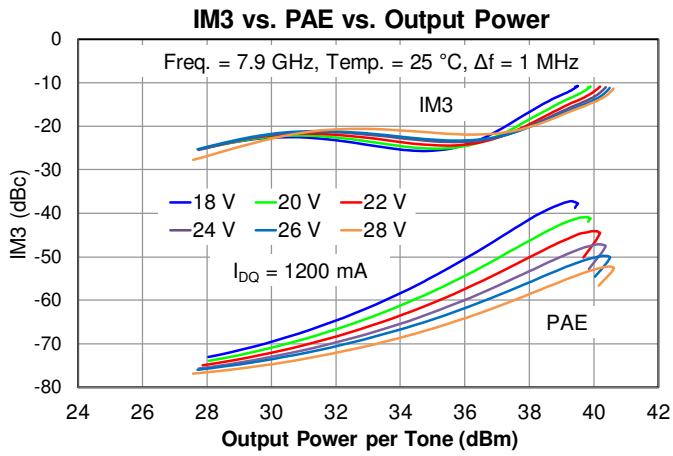

Performance Plots – Harmonics

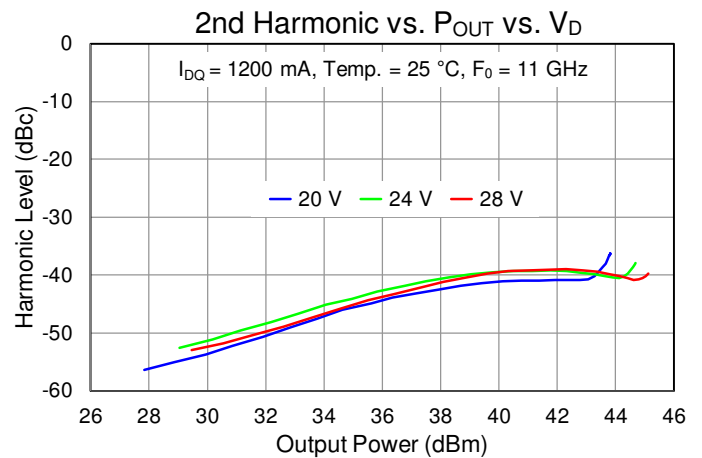
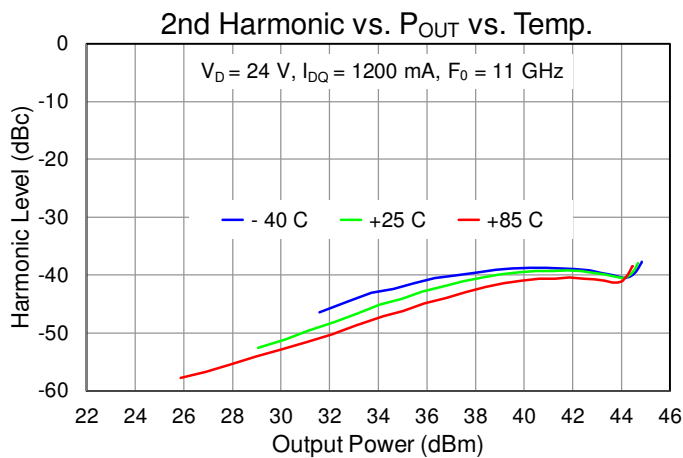
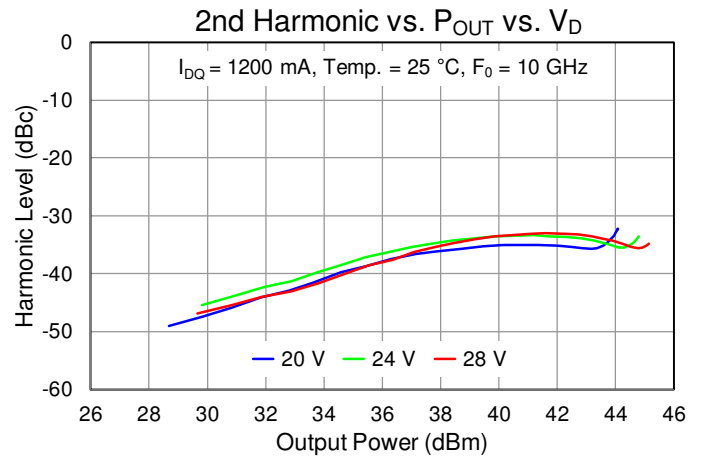
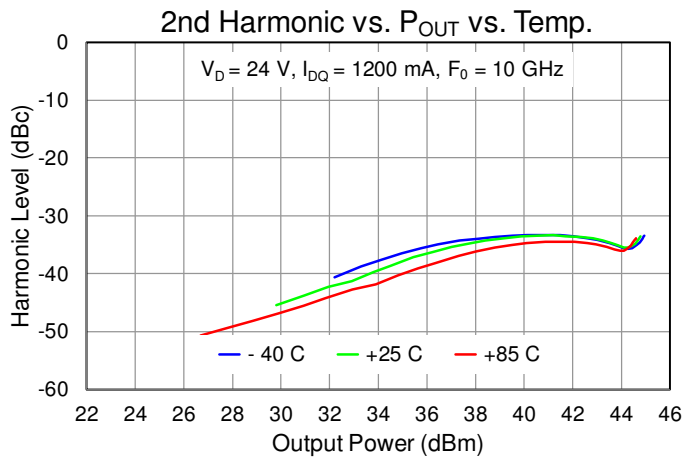
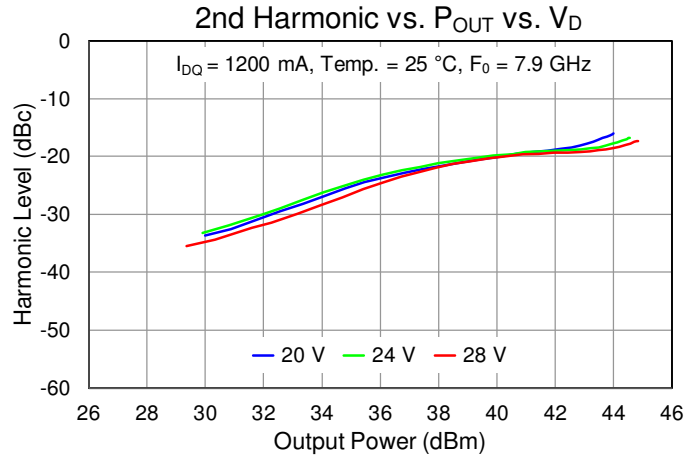
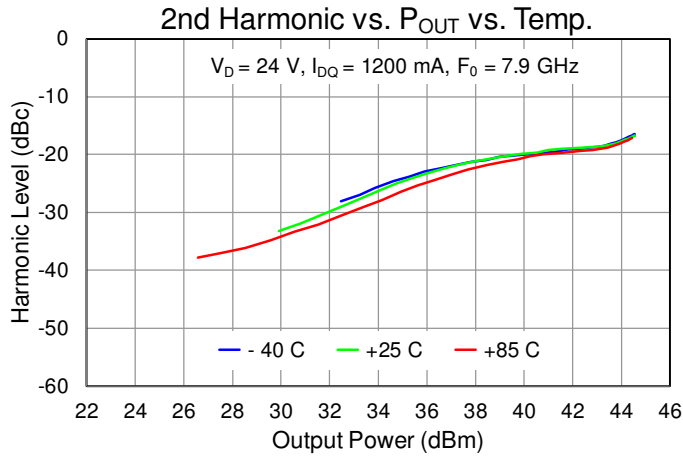

Performance Plots – Small Signal

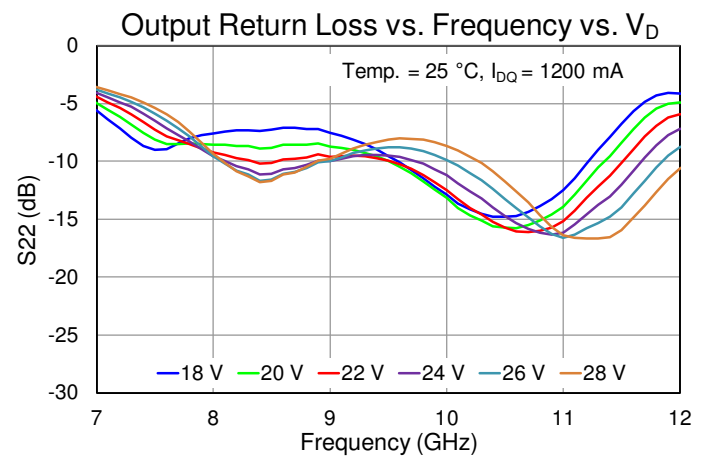
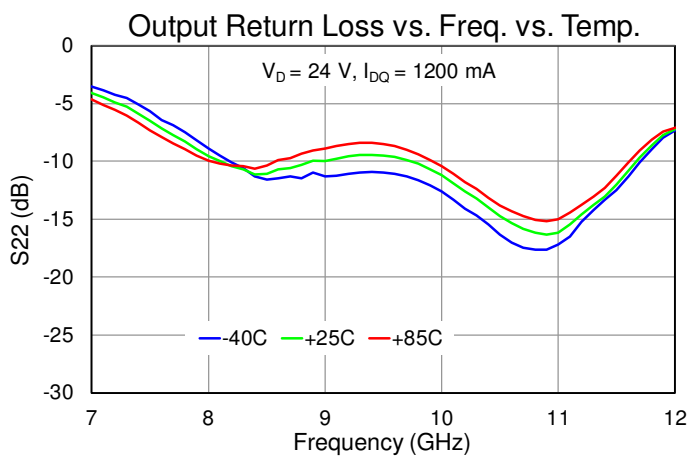
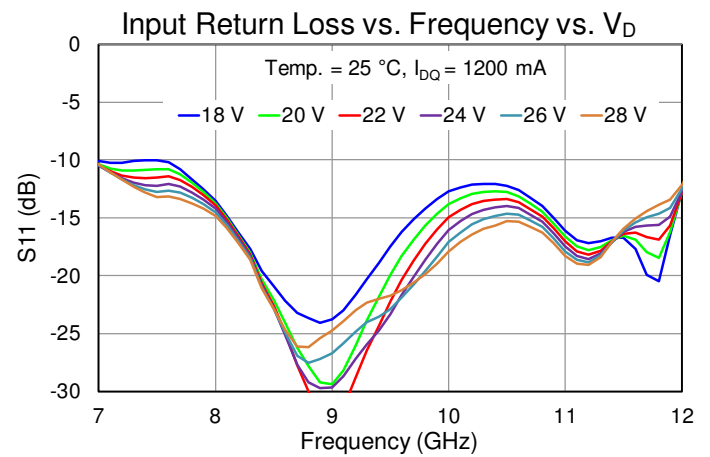
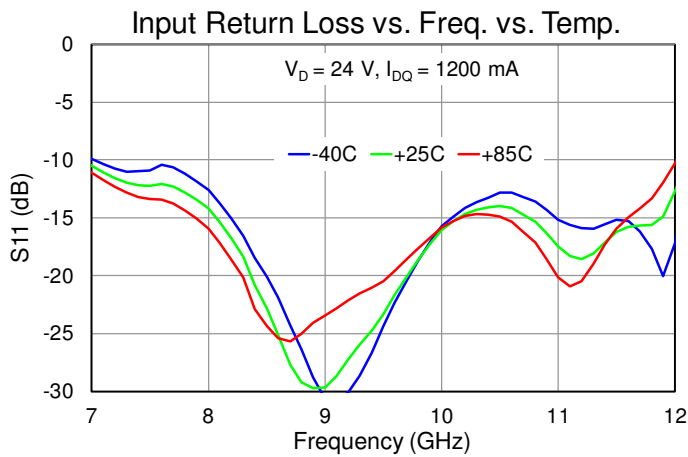
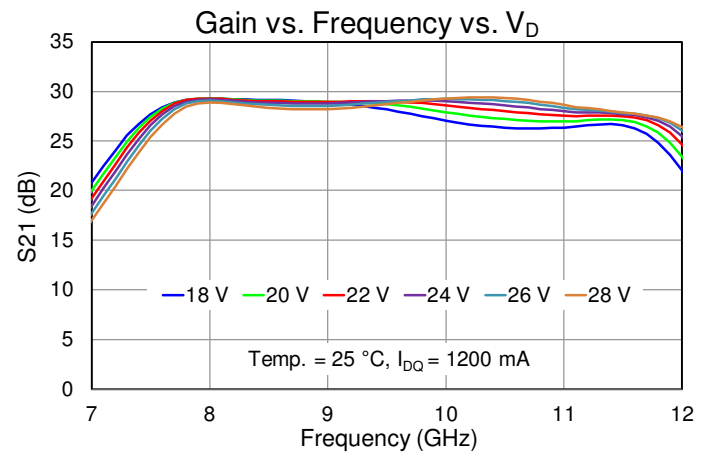
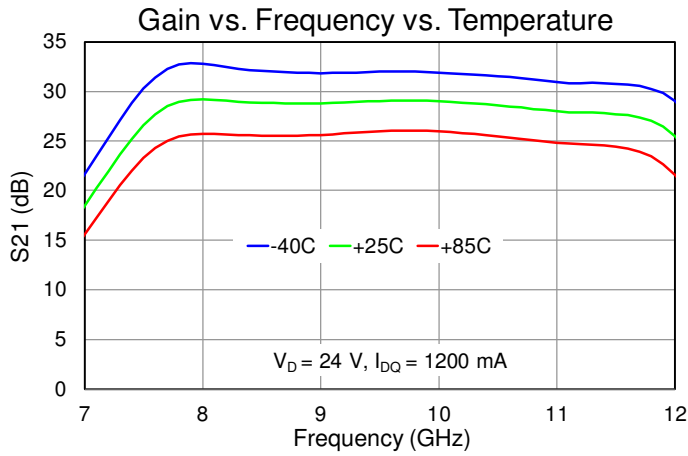

Performance Plots – Small Signal

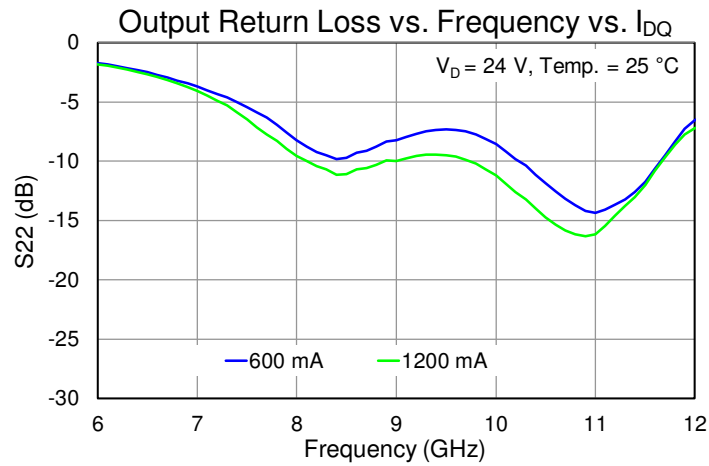
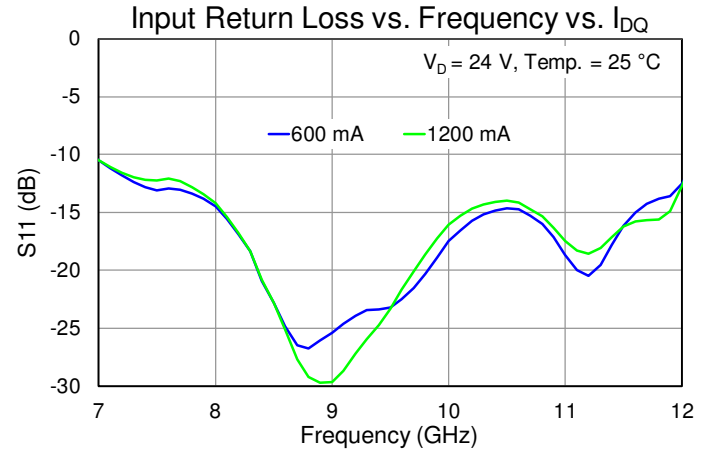
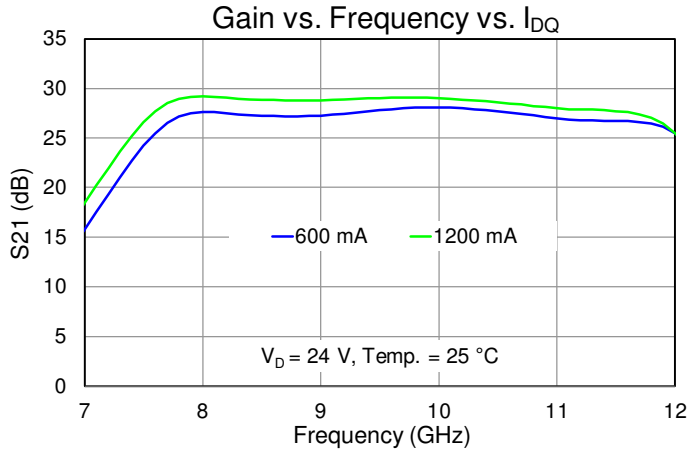

Thermal and Reliability Information

Parameter	Test Conditions	Value	Units
Thermal Resistance (θ_{JC}) ⁽¹⁾	$T_{BASE} = 85\text{ }^{\circ}\text{C}$, $V_D = +24\text{ V}$, $I_{DQ} = 1200\text{ mA}$,	1.49	$^{\circ}\text{C/W}$
Channel Temperature (T_{CH}) (Under RF drive)	Pulsed V_D : $PW = 100\text{ }\mu\text{s}$; $DC = 10\%$,	158	$^{\circ}\text{C}$
Median Lifetime (T_M)	Freq = 9.75 GHz, $P_{IN} = 25\text{ dBm}$, $I_{D_Drive} = 3.3\text{ A}$, $P_{OUT} = 44.7\text{ dBm}$, $P_{DISS} = 48.9\text{ W}$	3.6E +09	Hrs
Thermal Resistance (θ_{JC}) ⁽¹⁾	$T_{BASE} = 85\text{ }^{\circ}\text{C}$, $V_D = +24\text{ V}$, $I_{DQ} = 1200\text{ mA}$, CW,	2.13	$^{\circ}\text{C/W}$
Channel Temperature (T_{CH}) (Quiescent, No RF)	$P_{DISS} = 28.8\text{ W}$	147	$^{\circ}\text{C}$
Median Lifetime (T_M)		1.2E 10	Hrs
Thermal Resistance (θ_{JC}) ⁽¹⁾	$T_{BASE} = 85\text{ }^{\circ}\text{C}$, $V_D = +24\text{ V}$, $I_{DQ} = 1200\text{ mA}$, CW,	2.08	$^{\circ}\text{C/W}$
Channel Temperature (T_{CH}) (Under RF drive)	Freq = 9.75 GHz, $P_{IN} = 25\text{ dBm}$, $I_{D_Drive} = 2.9\text{ A}$,	178	$^{\circ}\text{C}$
Median Lifetime (T_M)	$P_{OUT} = 44.2\text{ dBm}$, $P_{DISS} = 44.7\text{ W}$	4.7E +08	Hrs
Thermal Resistance (θ_{JC}) ⁽¹⁾	$T_{BASE} = 85\text{ }^{\circ}\text{C}$, $V_D = +20\text{ V}$, $I_{DQ} = 1200\text{ mA}$,	1.39	$^{\circ}\text{C/W}$
Channel Temperature (T_{CH}) (Under RF drive)	Pulsed V_D : $PW = 100\text{ }\mu\text{s}$; $DC = 10\%$,	133	$^{\circ}\text{C}$
Median Lifetime (T_M)	Freq = 9.25 GHz, $P_{IN} = 25\text{ dBm}$, $I_{D_Drive} = 3.0\text{ A}$, $P_{OUT} = 44.1\text{ dBm}$, $P_{DISS} = 34.6\text{ W}$	6.0E +10	Hrs
Thermal Resistance (θ_{JC}) ⁽¹⁾	$T_{BASE} = 85\text{ }^{\circ}\text{C}$, $V_D = +20\text{ V}$, $I_{DQ} = 1200\text{ mA}$, CW,	2.13	$^{\circ}\text{C/W}$
Channel Temperature (T_{CH}) (Quiescent, No RF)	$P_{DISS} = 24\text{ W}$	136	$^{\circ}\text{C}$
Median Lifetime (T_M)		4.2E +10	Hrs
Thermal Resistance (θ_{JC}) ⁽¹⁾	$T_{BASE} = 85\text{ }^{\circ}\text{C}$, $V_D = +20\text{ V}$, $I_{DQ} = 1200\text{ mA}$, CW,	1.94	$^{\circ}\text{C/W}$
Channel Temperature (T_{CH}) (Under RF drive)	Freq = 9.5GHz, $P_{IN} = 25\text{ dBm}$, $I_{D_Drive} = 2.8\text{ A}$,	149	$^{\circ}\text{C}$
Median Lifetime (T_M)	$P_{OUT} = 43.7\text{ dBm}$, $P_{DISS} = 33\text{ W}$	9.4E +09	Hrs

Notes:

1. Thermal resistance is measured to the package backside.

Median Lifetime

Median Life Test Conditions: $V_D = +28\text{ V}$; Failure Criteria = 10% reduction in I_{D_MAX} during DC Life Testing

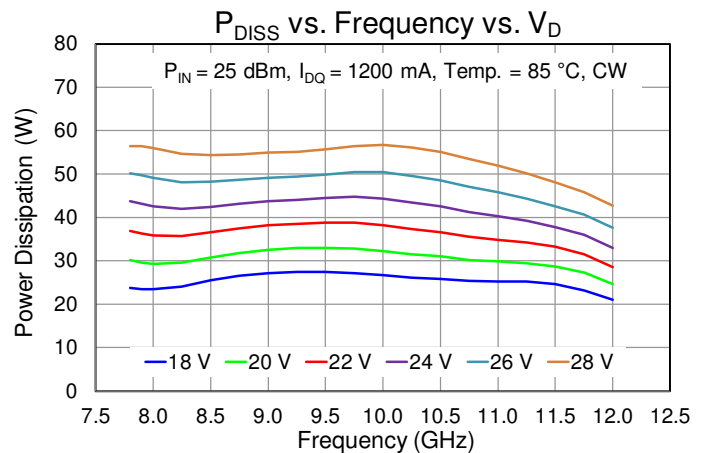
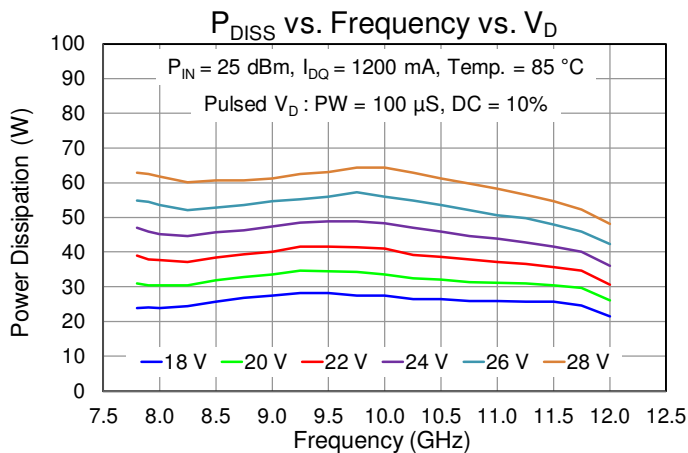
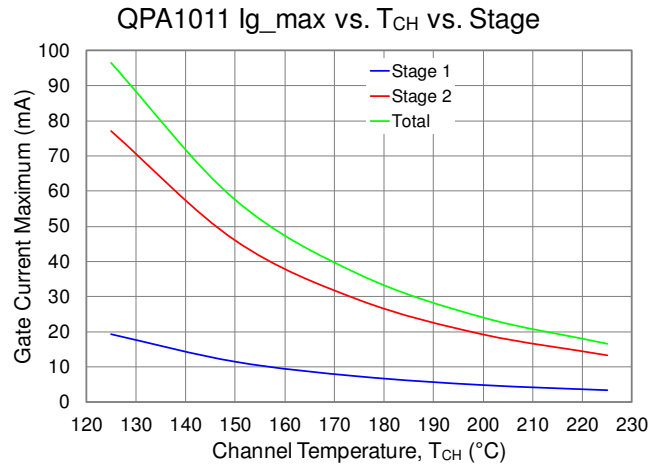
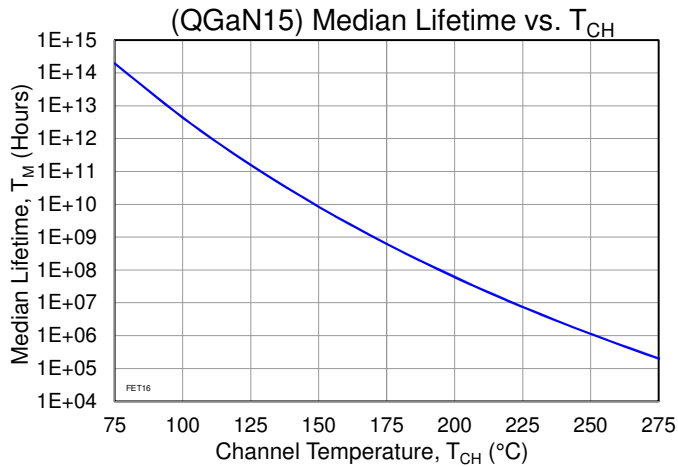

Applications Circuit for Linear and Pulsed Operations

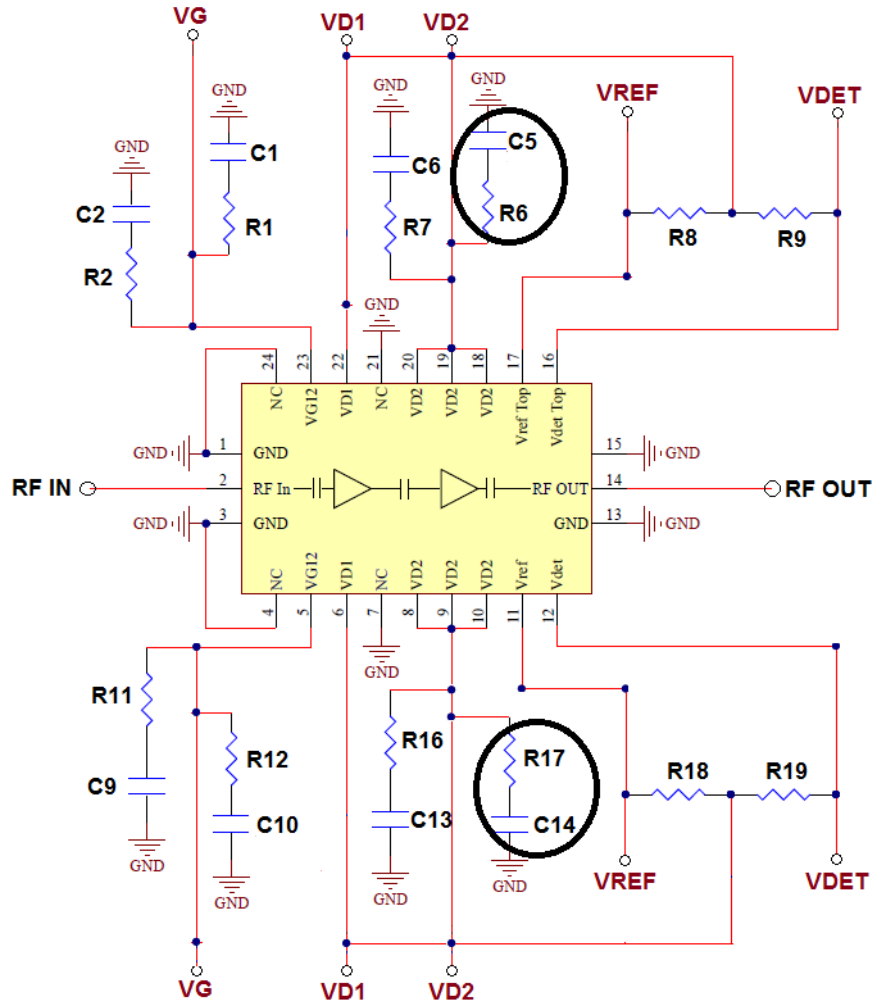

Note: $V_{\Delta} = V_{REF} - V_{DET}$

- QPA1011 can be biased from either the top side or bottom side.
- V_{D1} and V_{D2} need to be tied together
- V_{D1} / V_{D2} and V_{REF} / V_{DET} have to be on the same side for V_{Δ} to work.
- Bypassing components required for the side(s) being biased.
- The extra bias components (R6, R17, C5 and C14) are required for optimum linearity.

Bias Up Procedure

1. Set I_D limit to 4000 mA, I_G limit to 20 mA
2. Apply -5 V to V_G
3. Apply $+24\text{ V}$ to V_D ; ensure I_{DQ} is approx. 0 mA
4. Adjust V_G until $I_{DQ} = 1200\text{ mA}$ ($V_G \sim -1.9\text{ V Typ.}$).
5. Turn on RF supply

Bias Down Procedure

1. Turn off RF supply
2. Reduce V_G to -5 V ; ensure I_{DQ} is approx. 0 mA
3. Set V_D to 0 V
4. Turn off V_D supply
5. Turn off V_G supply

Evaluation Board (EVB) Layout Assembly for Pulsed Operation

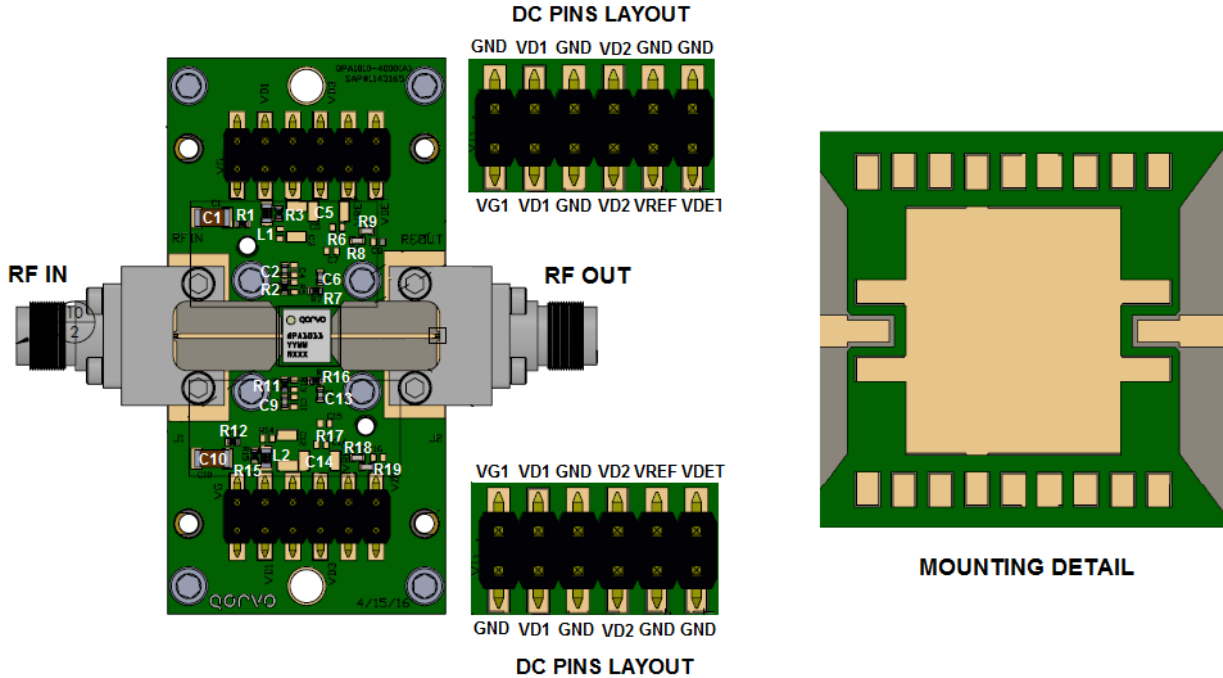

Note: PCB is a multilayer

1. All 4 metal thicknesses are 0.5 oz
2. Upper core 1 is Rogers 4003C, 8 mil thick
3. Lower core 2 is 370HR, 6 mil thick
4. Pre-Preg is an epoxy coated glass fabric
5. Total finished PCB thickness is 25 ±3 mil
6. This EVB uses a copper-coined PCB for optimum thermal management under high dissipation long pulse and/or CW conditions

Bill of Materials for EVB

Reference Des.	Value	Description	Manuf.	Part Number
C1, C5, C10, C14	10 uF	CAP, 1206, 50 V, 20 %, X5R	Various	–
C2, C6, C9, C13	0.01 uF	CAP, 0402, 50 V, 10 %, X7R	Various	–
R1, R12	5.1 Ohm	RES, 0402, 50V, 5 %, SMT	Various	–
R2, R3, R6, R7, R11, R15, R16, R17 ⁽¹⁾	0 Ohm	RES, 0402, 5 %, SMD	Various	–
R8, R9, R18, R19	25.5 K Ohm	RES, 0402, 1/16W, 1%, 0402	Various	–
L1, L2 ⁽¹⁾	0 Ohm	RES, 0603, 1/10 W	Various	–

Note:

1. These components are acting as the jumpers for this EVB.

Mechanical Information

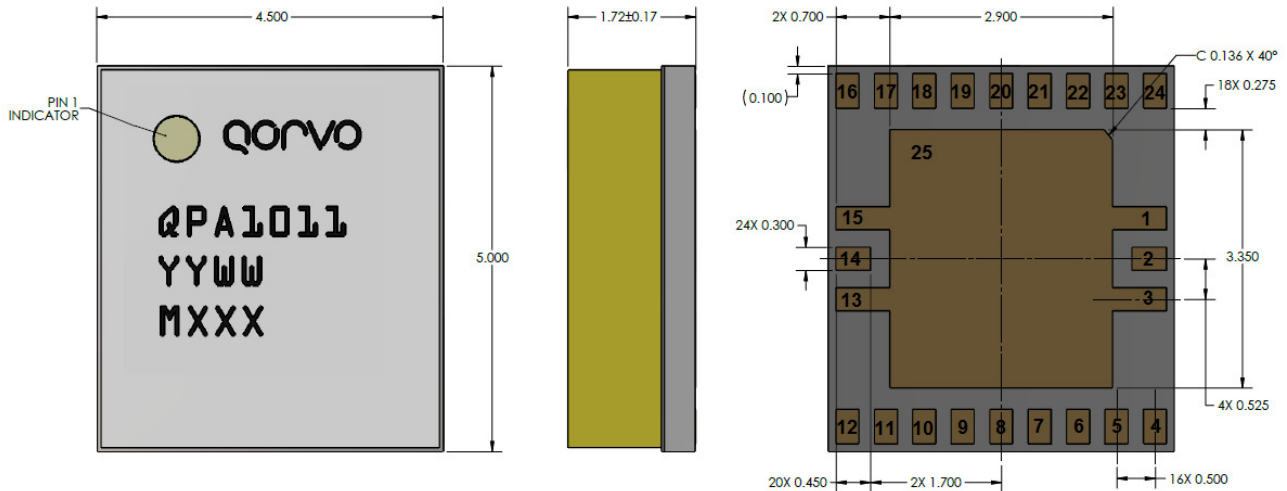

Units: millimeters
 Tolerances: unless specified
 x.xx = ± 0.25
 x.xxx = ± 0.100
 Materials:
 Base: Laminate
 Lid: FR4
 All metalized features are gold plated
 Part is epoxy sealed
 Marking:
 QPA1011: Part number
 YY: Part Assembly year
 WW: Part Assembly week
 MXXX: Batch ID

Pin Description

Pad No.	Symbol	Description
1, 3, 13, 15, Center	GND	Ground. Must be grounded on the PCB. Conductive filled vias recommended for least inductance and improved thermal performance
2	RF _{IN}	RF Input; matched to 50 Ω; DC blocked
4, 7, 21, 24	N/C	Not connected internally. Recommended to be grounded
5, 23	V _{G1-2}	Stage 1-2 Gate Voltage. Bias network is required; see recommended Application Information above on page 21
6, 22	V _{D1}	Stage 1 Drain Voltage. Bias network is required; see recommended Application Information above on page 21
8 – 10, 18 - 20	V _{D2}	Stage 2 Drain voltage; Bias network is required; must be biased from both sides; see recommended Application Information above on page 21
11, 17	V _{REF}	Reference voltage
12, 16	V _{DET}	Detector voltage
14	RF _{OUT}	RF Output; matched to 50 Ω; DC blocked

Handling Precautions

Parameter	Rating	Standard
ESD – Human Body Model (HBM)	TBD	ESDA / JEDEC JS-001-2012
ESD – Charged Device Model (CDM)	TBD	ESDA / JEDEC JS-002-2014
MSL – Convection Reflow 260 °C	TBD	JEDEC standard IPC/JEDEC J-STD-020



Caution!
ESD-Sensitive Device

Solderability

Compatible with the latest version of J-STD-020, Lead-free solder, 260 °C

RoHS Compliance

This product is compliant with the 2011/65/EU RoHS directive (Restrictions on the Use of Certain Hazardous Substances in Electrical and Electronic Equipment), as amended by Directive 2015/863/EU. This product also has the following attributes:

- Lead Free
- Antimony Free
- TBBP-A (C₁₅H₁₂Br₄O₂) Free
- PFOS Free
- SVHC Free
- Qorvo Green

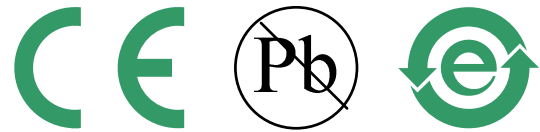

Contact Information

For the latest specifications, additional product information, worldwide sales and distribution locations:

Tel: 1-844-890-8163

Web: www.qorvo.com

Email: customer.support@qorvo.com

For technical questions and application information: **Email: sjapplications.engineering@qorvo.com**

Important Notice

The information contained herein is believed to be reliable; however, Qorvo makes no warranties regarding the information contained herein and assumes no responsibility or liability whatsoever for the use of the information contained herein. All information contained herein is subject to change without notice. Customers should obtain and verify the latest relevant information before placing orders for Qorvo products. The information contained herein or any use of such information does not grant, explicitly or implicitly, to any party any patent rights, licenses, or any other intellectual property rights, whether with regard to such information itself or anything described by such information. **THIS INFORMATION DOES NOT CONSTITUTE A WARRANTY WITH RESPECT TO THE PRODUCTS DESCRIBED HEREIN, AND QORVO HEREBY DISCLAIMS ANY AND ALL WARRANTIES WITH RESPECT TO SUCH PRODUCTS WHETHER EXPRESS OR IMPLIED BY LAW, COURSE OF DEALING, COURSE OF PERFORMANCE, USAGE OF TRADE OR OTHERWISE, INCLUDING THE IMPLIED WARRANTIES OF MERCHANTABILITY AND FITNESS FOR A PARTICULAR PURPOSE.**

Without limiting the generality of the foregoing, Qorvo products are not warranted or authorized for use as critical components in medical, life-saving, or life-sustaining applications, or other applications where a failure would reasonably be expected to cause severe personal injury or death.

Copyright 2016 © Qorvo, Inc. | Qorvo is a registered trademark of Qorvo, Inc.