

Load Switch ICs

0.5A, 1.0A Load Switch ICs

BD2200GUL BD2201GUL

General Description

BD2200GUL and BD2201GUL are load switch ICs (N-Channel MOSFET) for portable devices. These ICs have an ON-Resistance of 100mΩ (Typ). Furthermore, soft-start and output discharge circuits are integrated.

Features

- Single Channel of Low ON-Resistance N-Channel MOSFET Built in
- Soft-Start Circuit
- Output Discharge Circuit

Applications

Load Switches for Mobile Phone , Digital Still Cameras, PDA, MP3 Players, PCs, Portable Devices

Key Specifications

- Input Voltage Range: 2.7V to 5.5V
- ON-Resistance: 100mΩ(Typ)
- Continuous Current:
 - BD2200GUL 0.5A(Max)
 - BD2201GUL 1.0A(Max)
- Standby Current: 0.01μA(Typ)
- Operating Temperature Range: -25°C to +85°C

Package

W(Typ) D(Typ) H(Max)

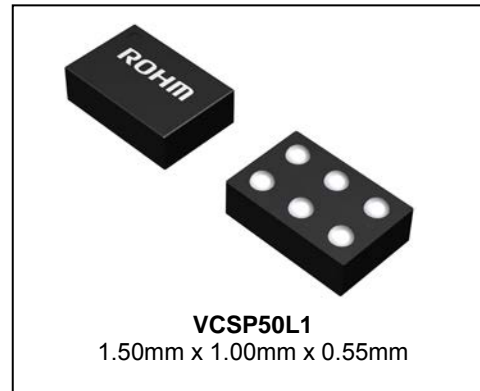

Typical Application Circuit

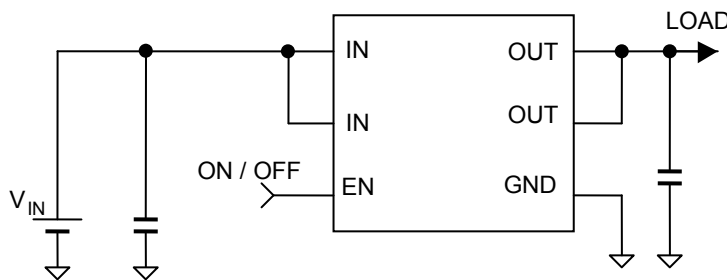

Lineup

On-Resistance	Output Current	Output Turn On Time	Control Logic	Package		Orderable Part Number
100mΩ	0.5A	1.0ms	High	VCSP50L1	Reel of 3000	BD2200GUL-E2
100mΩ	1.0A	1.0ms	High	VCSP50L1	Reel of 3000	BD2201GUL-E2

Block Diagram

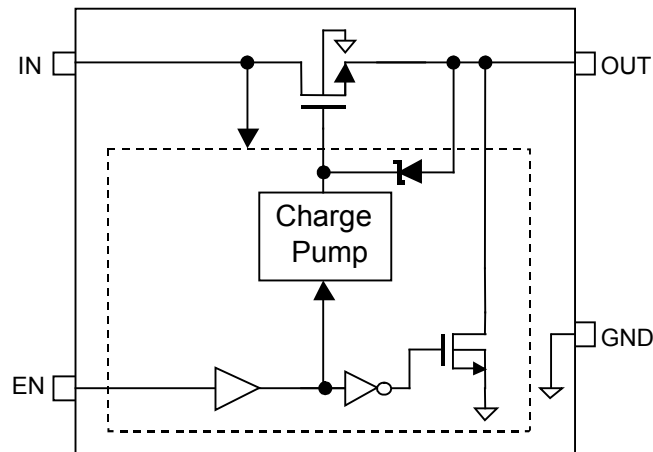

Pin Configuration

(BOTTOM VIEW)

B	IN	OUT	OUT
A	IN	EN	GND
	1	2	3

Pin Description

Pin Number	Pin Name	Pin Function
A3	GND	Ground
B2, B3	OUT	Switch output (Connect each pin externally)
A1, B1	IN	Switch input (Connect each pin externally)
A2	EN	Enable input (Active-high switch on input)

Absolute Maximum Ratings (Ta=25°C)

Parameter	Symbol	Rating	Unit
IN Supply Voltage	V _{IN}	-0.3 to +6.0	V
EN Input Voltage	V _{EN}	-0.3 to V _{IN} + 0.3	V
OUT Voltage	V _{OUT}	-0.3 to +6.0	V
Storage Temperature	T _{stg}	-55 to +150	°C
Power Dissipation	P _d	0.57 (Note 1)	W

(Note 1) Derate by 4.6mW/°C when operating above Ta=25°C (mounted on 50mm x 58mm x 1.75mm board).

Caution: Operating the IC over the absolute maximum ratings may damage the IC. The damage can either be a short circuit between pins or an open circuit between pins and the internal circuitry. Therefore, it is important to consider circuit protection measures, such as adding a fuse, in case the IC is operated over the absolute maximum ratings.

Recommended Operating Conditions

Parameter	Symbol	Rating			Unit
		Min	Typ	Max	
Switch Input Voltage	V _{IN}	2.7	3.3	5.5	V
Operation Temperature	T _{opr}	-25	+25	+85	°C
Output Current (BD2200GUL)	I _{LO}	0	-	500	mA
Output Current (BD2201GUL)	I _{LO}	0	-	1000	mA

Electrical Characteristics

BD2200GUL (Unless otherwise specified, V_{IN} = 3.3V, Ta = 25°C)

Parameter	Symbol	Limit			Unit	Conditions
		Min	Typ	Max		
[Current Consumption]						
Operating Current	I _{DD}	-	20	30	μA	V _{EN} = 1.2V, V _{OUT} = Open
Standby Current	I _{STB}	-	0.01	1	μA	V _{EN} = 0V, V _{OUT} = Open
[I/O]						
EN Input Voltage	V _{ENH}	1.2	-	-	V	High Level Input
	V _{ENL}	-	-	0.4	V	Low Level Input
EN Input Current	I _{EN}	-1	-	+1	μA	V _{EN} = 0V or V _{EN} = 1.2V
[Power Switch]						
ON-Resistance	R _{ON}	-	100	200	mΩ	I _{LO} = 500mA
Switch Leakage Current	I _{LEAK}	-	0.01	1	μA	V _{EN} = 0V, V _{OUT} = 0V
Output Rise Time	t _{ON1}	-	1.0	2.0	ms	R _L = 10Ω, V _{OUT} : 10% to 90%
Output Turn-ON Time	t _{ON2}	-	1.2	2.4	ms	R _L = 10Ω, V _{EN} : 50% to V _{OUT} : 90%
Output Fall Time	t _{OFF1}	-	2.5	5.0	μs	R _L = 10Ω, V _{OUT} : 90% to 10%
Output Turn-Off Time	t _{OFF2}	-	4.5	9.0	μs	R _L = 10Ω, V _{EN} : 50% to V _{OUT} : 10%
[Discharge Circuit]						
Discharge ON-Resistance	R _{DISC}	-	70	110	Ω	I _{LO} = -1mA, V _{EN} = 0V
Discharge Current	I _{DISC}	-	15	20	mA	V _{OUT} = 3.3V, V _{EN} = 0V

Electrical Characteristics - continued

BD2201GUL (Unless otherwise specified, $V_{IN} = 3.3V$, $T_a = 25^\circ C$)

Parameter	Symbol	Limit			Unit	Conditions
		Min	Typ	Max		
[Current Consumption]						
Operating Current	I_{DD}	-	20	30	μA	$V_{EN} = 1.2V, V_{OUT} = \text{Open}$
Standby Current	I_{STB}	-	0.01	1	μA	$V_{EN} = 0V, V_{OUT} = \text{Open}$
[I/O]						
EN Input Voltage	V_{ENH}	1.2	-	-	V	High Level Input
	V_{ENL}	-	-	0.4	V	Low Level Input
EN Input Current	I_{EN}	-1	-	+1	μA	$V_{EN} = 0V$ or $V_{EN} = 1.2V$
[Power Switch]						
ON-Resistance	R_{ON}	-	100	180	$m\Omega$	$I_{LO} = 500mA$
Switch Leakage Current	I_{LEAK}	-	0.01	1	μA	$V_{EN} = 0V, V_{OUT} = 0V$
Output Rise Time	t_{ON1}	-	1.0	2.0	ms	$R_L = 10\Omega, V_{OUT}: 10\% \text{ to } 90\%$
Output Turn-ON Time	t_{ON2}	-	1.2	2.4	ms	$R_L = 10\Omega, V_{EN}: 50\% \text{ to } V_{OUT}: 90\%$
Output Fall Time	t_{OFF1}	-	2.5	5.0	μs	$R_L = 10\Omega, V_{OUT}: 90\% \text{ to } 10\%$
Output Turn-OFF Time	t_{OFF2}	-	4.5	9.0	μs	$R_L = 10\Omega, V_{EN}: 50\% \text{ to } V_{OUT}: 10\%$
[Discharge Circuit]						
Discharge ON-Resistance	R_{DISC}	-	70	110	Ω	$I_{LO} = -1mA, V_{EN} = 0V$
Discharge Current	I_{DISC}	-	15	20	mA	$V_{OUT} = 3.3V, V_{EN} = 0V$

Test Circuit

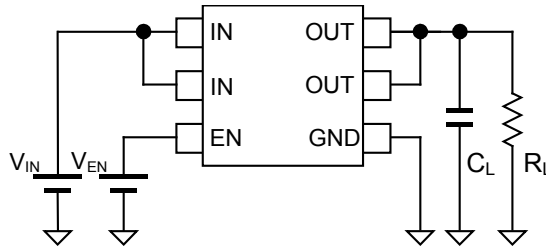

Switch Output Turn ON/OFF Timing

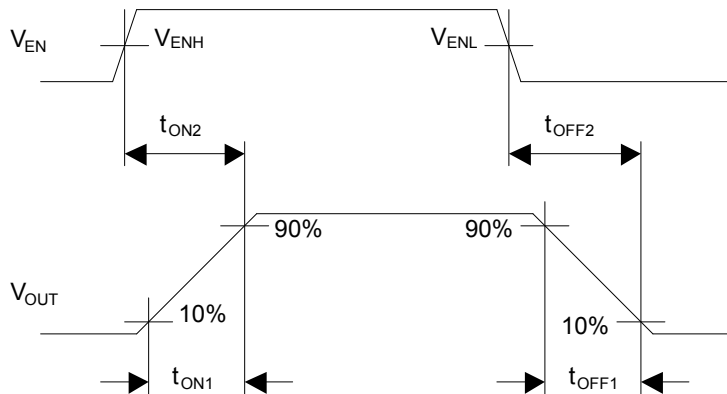

Typical Performance Curves

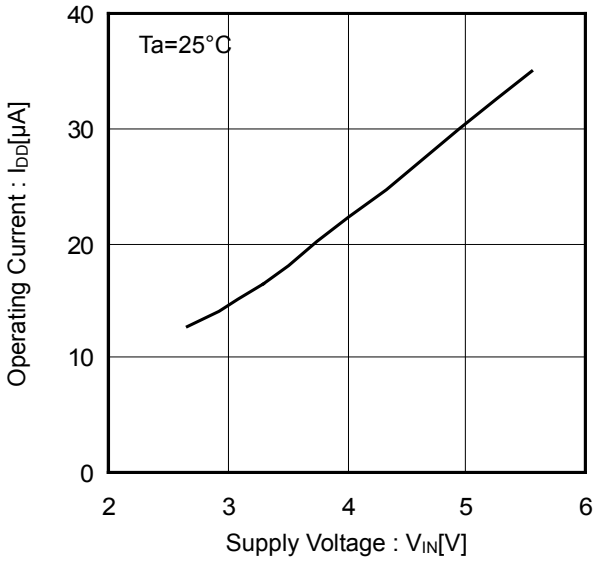

Figure 1. Operating Current vs Supply Voltage (EN Enable)

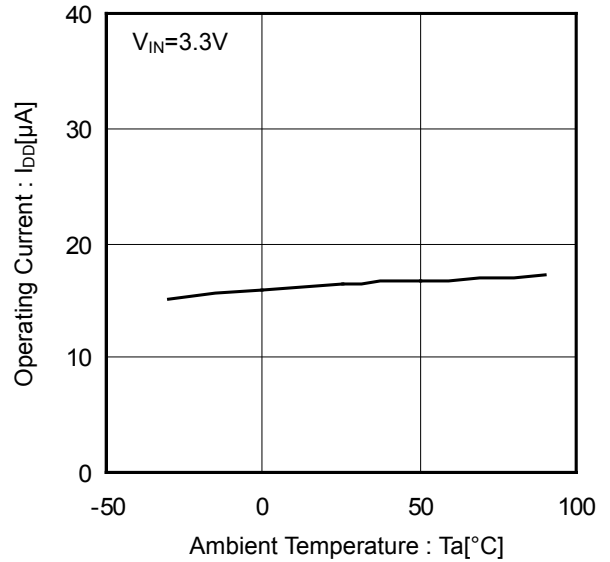

Figure 2. Operating Current vs Ambient Temperature (EN Enable)

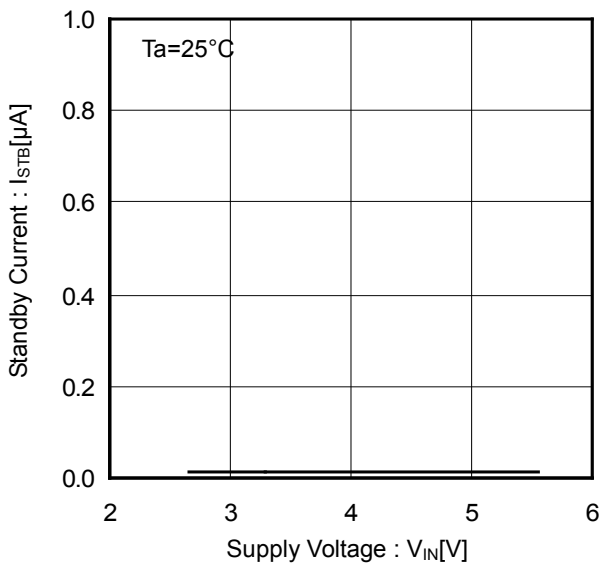

Figure 3. Standby Current vs Supply Voltage (EN Disable)

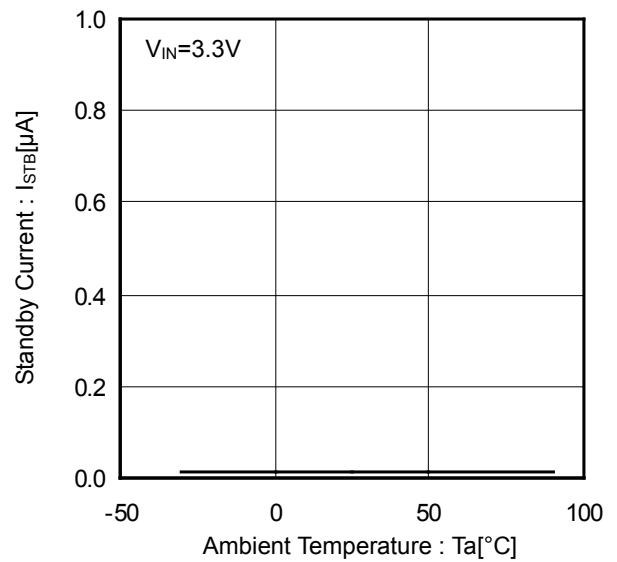

Figure 4. Standby Current vs Ambient Temperature (EN Disable)

Typical Performance Curves - continued

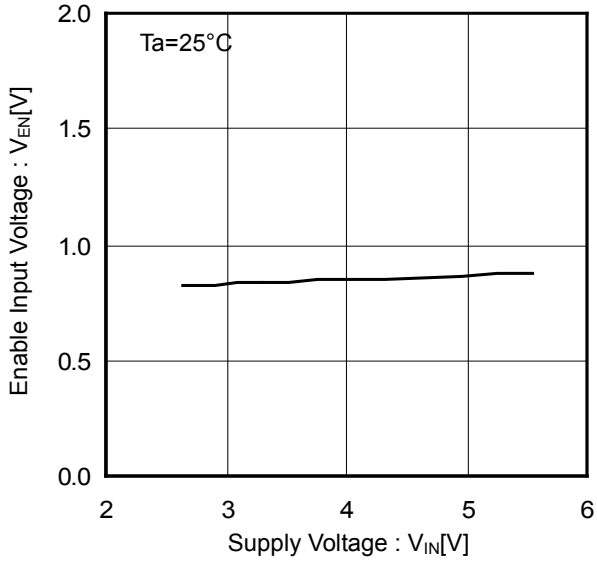

Figure 5. EN Input Voltage vs Supply Voltage

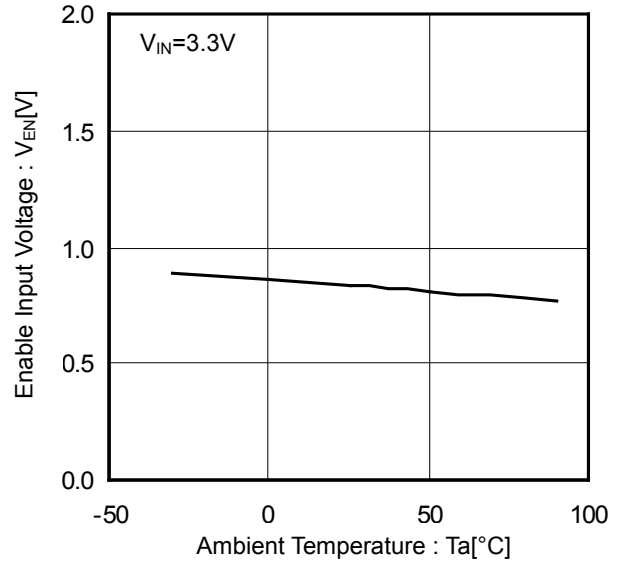

Figure 6. EN Input Voltage vs Ambient Temperature

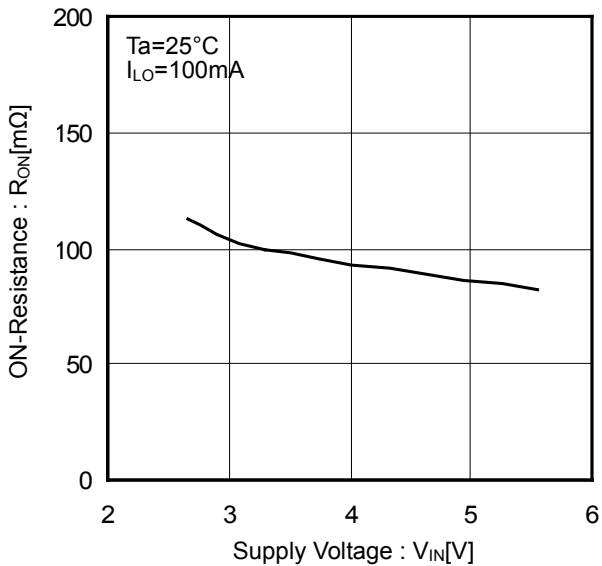

Figure 7. ON-Resistance vs Supply Voltage

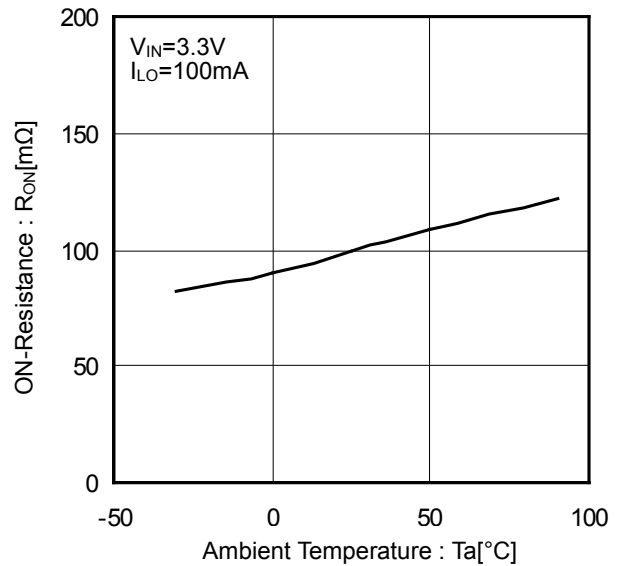

Figure 8. ON-Resistance vs Ambient Temperature

Typical Performance Curves - continued

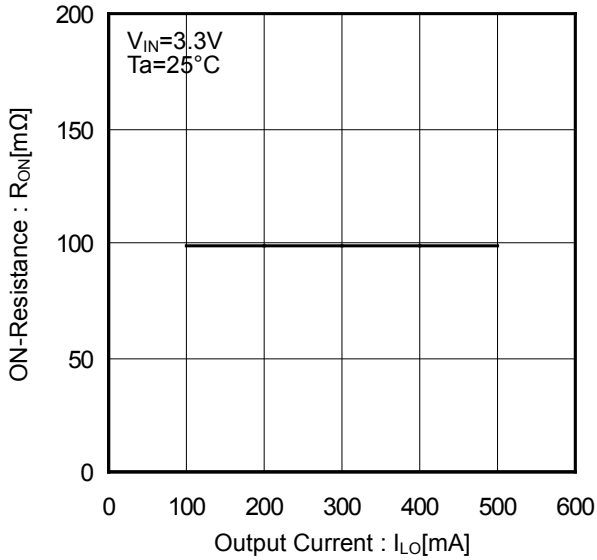

Figure 9. ON-Resistance vs Output Current

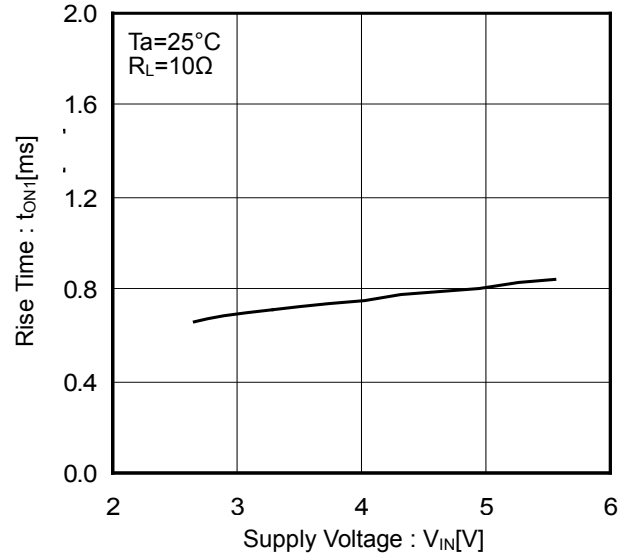

Figure 10. Output Rise Time vs Supply Voltage

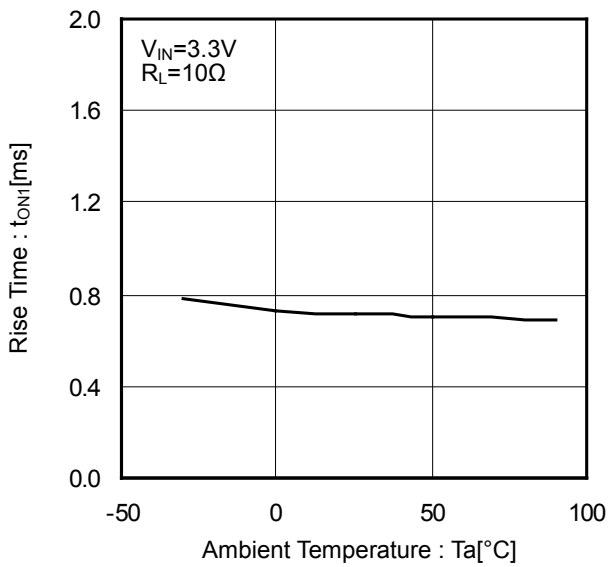

Figure 11. Output Rise Time vs Ambient Temperature

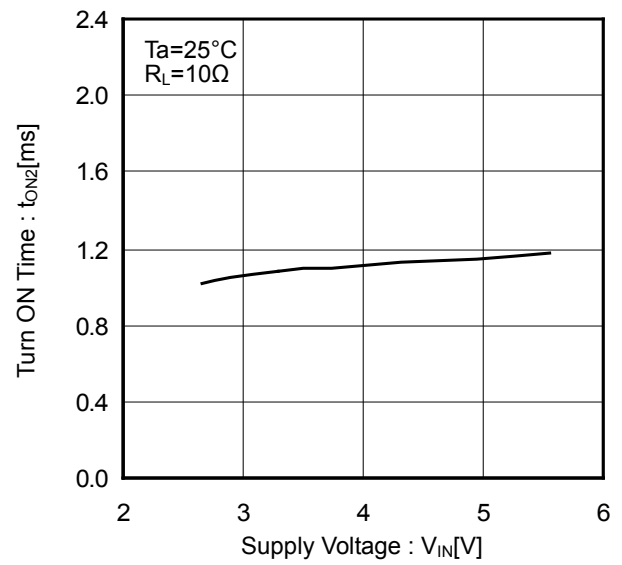

Figure 12. Output Turn ON Time vs Supply Voltage

Typical Performance Curves - continued

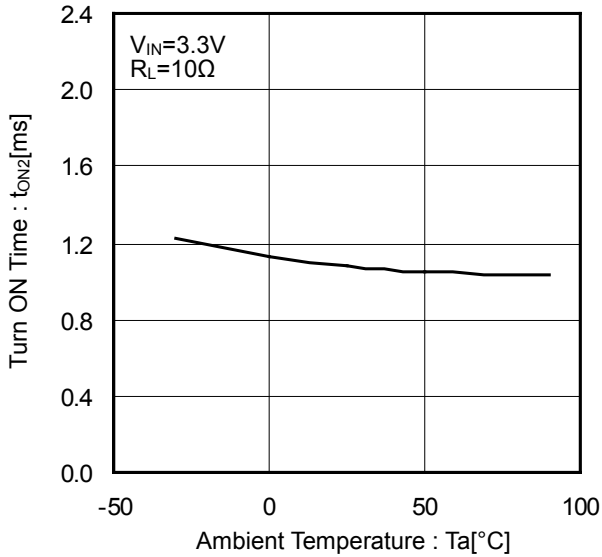

Figure 13. Output Turn ON Time vs Ambient Temperature

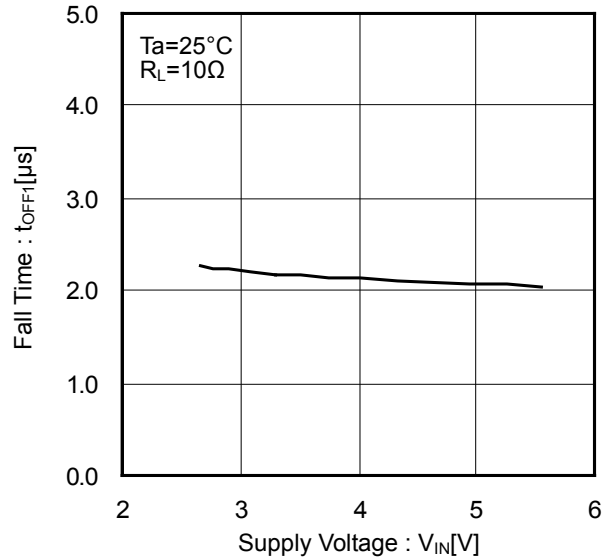

Figure 14. Output Fall Time vs Supply Voltage

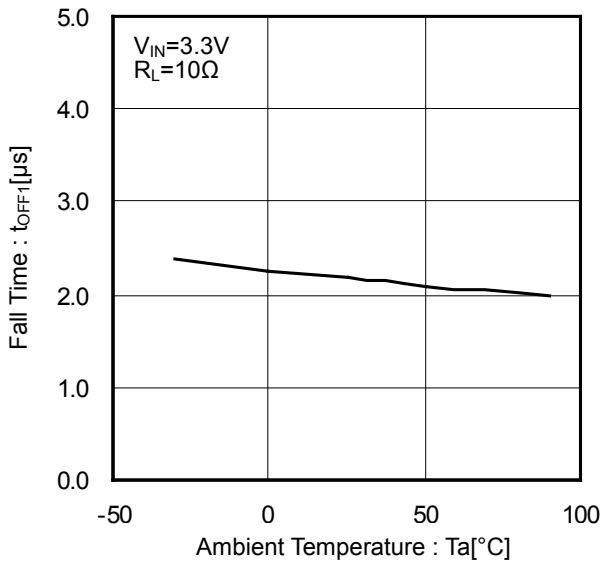

Figure 15. Output Fall Time vs Ambient Temperature

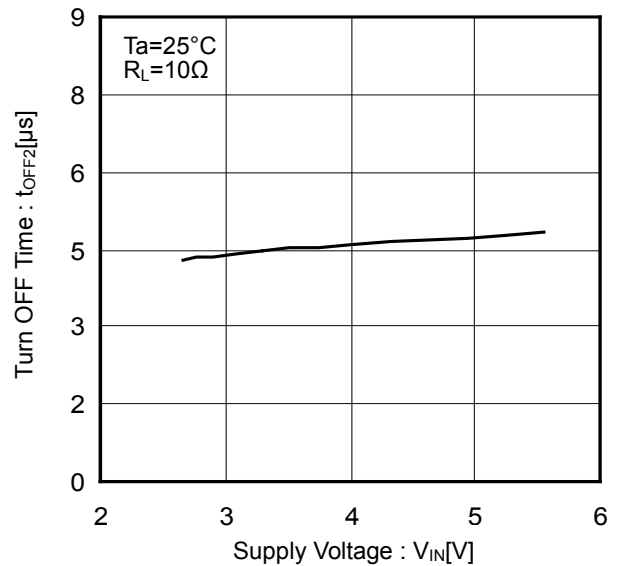

Figure 16. Output Turn OFF Time vs Supply Voltage

Typical Performance Curves - continued

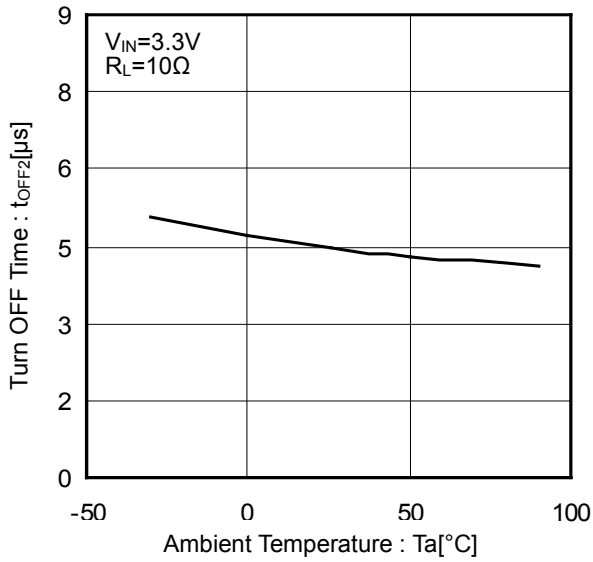

Figure 17. Output Turn OFF Time vs Ambient Temperature

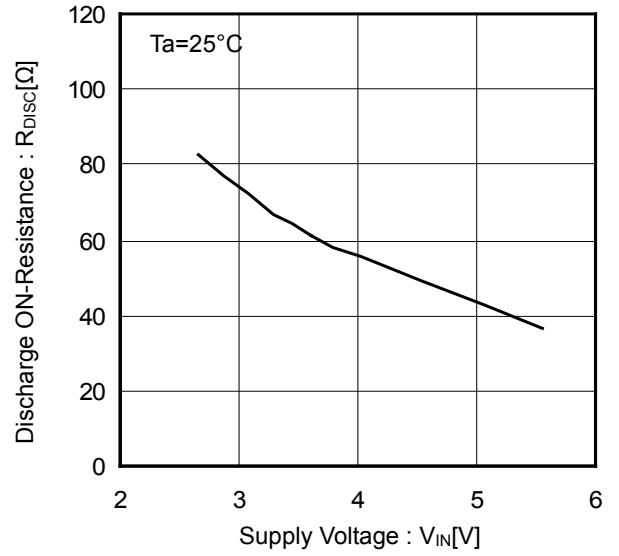

Figure 18. Discharge ON-Resistance vs Supply Voltage

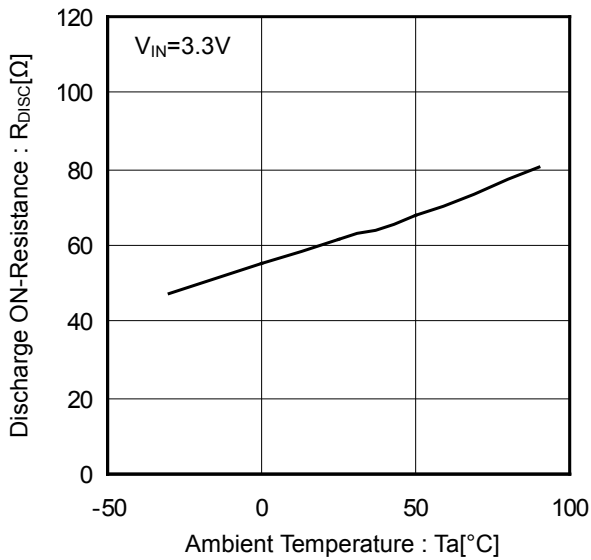

Figure 19. Discharge ON-Resistance vs Ambient Temperature

Typical Wave Forms
(BD2200GUL)

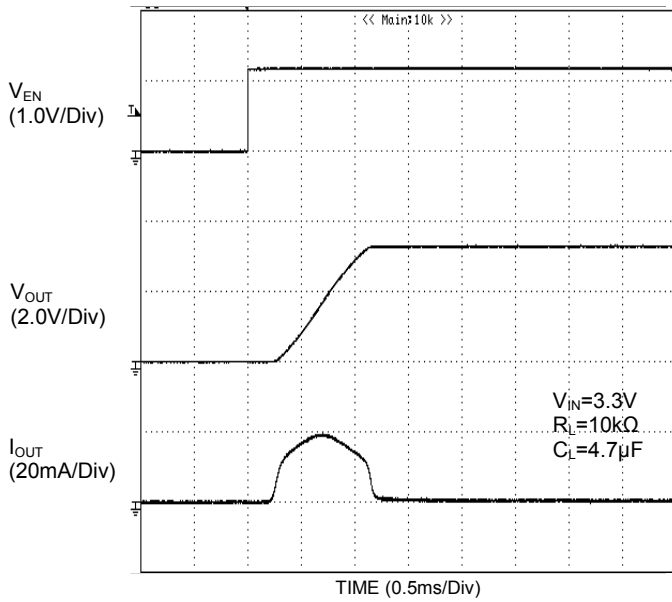

Figure 20. Output Turn ON Response
($V_{IN}=3.3V$ $R_L=10k\Omega$ $C_L=4.7\mu F$)

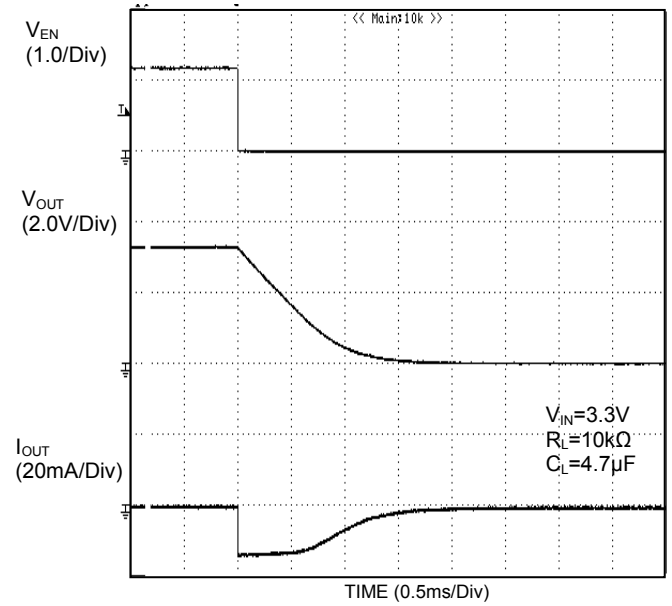

Figure 21. Output Turn OFF Response
($V_{IN}=3.3V$ $R_L=10k\Omega$ $C_L=4.7\mu F$)

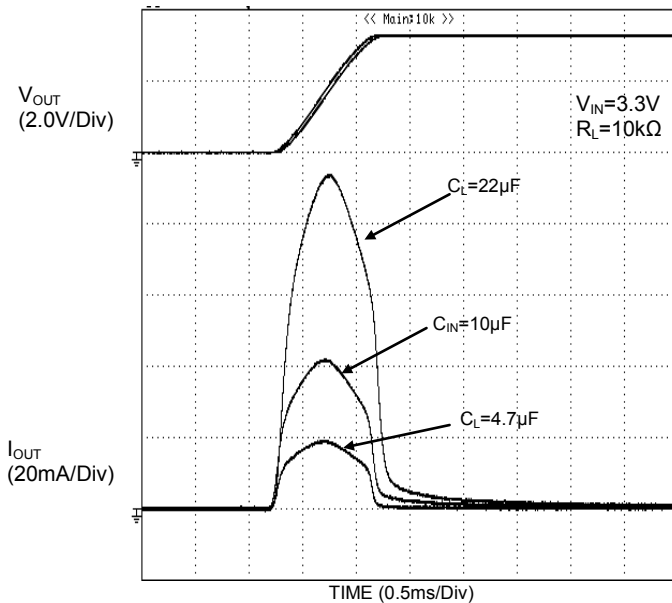
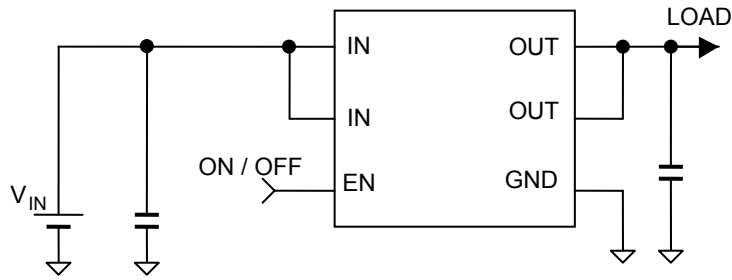

Figure 22. Rush Current Response
($V_{IN}=3.3V$ $R_L=10k\Omega$)

Application Circuit Example



This application circuit does not guarantee its operation. When using the circuit with changes to the external circuit constants, make sure to leave an adequate margin for external components including AC/DC characteristics as well as dispersion of the IC.

Functional Description

1. Switch Operation
 IN and OUT are connected to the MOSFET's drain and source. By setting the EN input to high, the internal charge pump operates and turns on the MOSFET. When the MOSFET is turned on, the switch becomes bi-directional. Consequently, when $V_{IN} < V_{OUT}$, the current is flowing from OUT to IN.

2. Output Discharge Circuit
 The output discharge circuit operates when the switch is turned off. During its operation, a 70Ω (Typ) resistor is connected between OUT and GND. Unwanted electrical charge is discharged quickly into this resistor.

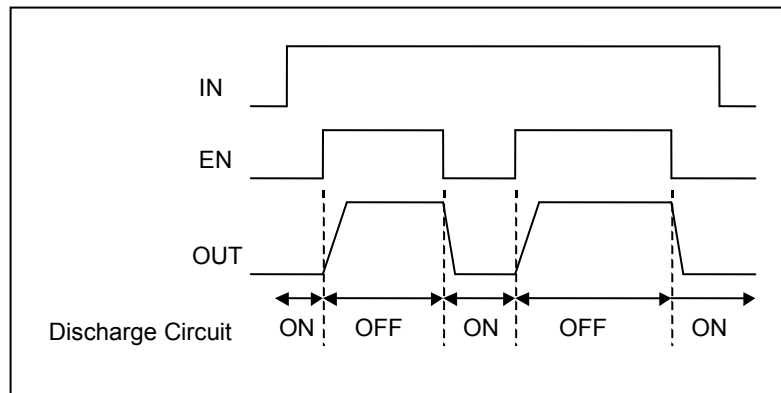
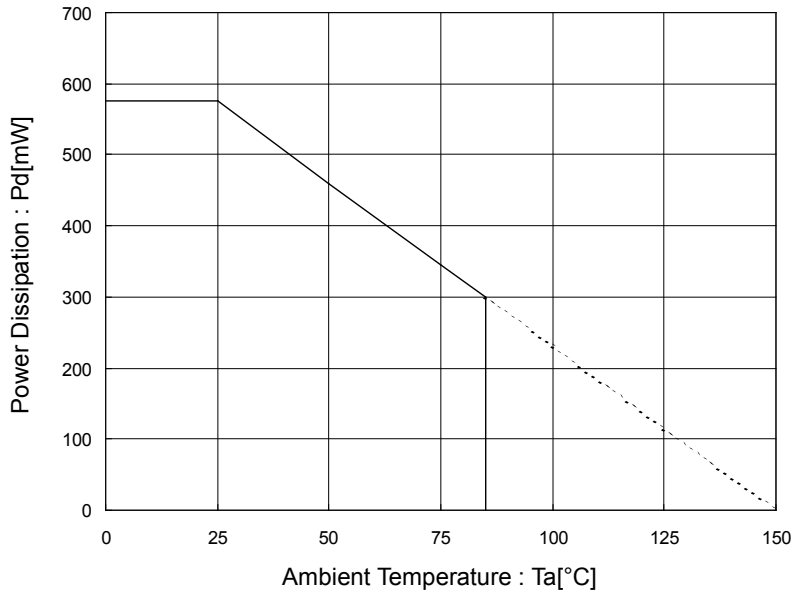

Figure 23. Timing Diagram

Power Dissipation



50mm x 58mm x 1.75mm Glass Epoxy Board

Figure 24. Power Dissipation Curve (Pd-Ta Curve)
(VCSP50L1 Package)

I/O Equivalence Circuit

Pin Name	Pin Number	Equivalence Circuit
EN	A2	
IN OUT	A1, B1 B2, B3	

Operational Notes

1. Reverse Connection of Power Supply

Connecting the power supply in reverse polarity can damage the IC. Take precautions against reverse polarity when connecting the power supply, such as mounting an external diode between the power supply and the IC's power supply pins.

2. Power Supply Lines

Design the PCB layout pattern to provide low impedance supply lines. Separate the ground and supply lines of the digital and analog blocks to prevent noise in the ground and supply lines of the digital block from affecting the analog block. Furthermore, connect a capacitor to ground at all power supply pins. Consider the effect of temperature and aging on the capacitance value when using electrolytic capacitors.

3. Ground Voltage

Ensure that no pins are at a voltage below that of the ground pin at any time, even during transient condition.

4. Ground Wiring Pattern

When using both small-signal and large-current ground traces, the two ground traces should be routed separately but connected to a single ground at the reference point of the application board to avoid fluctuations in the small-signal ground caused by large currents. Also ensure that the ground traces of external components do not cause variations on the ground voltage. The ground lines must be as short and thick as possible to reduce line impedance.

5. Thermal Consideration

Should by any chance the power dissipation rating be exceeded the rise in temperature of the chip may result in deterioration of the properties of the chip. The absolute maximum rating of the Pd stated in this specification is when the IC is mounted on a 70mm x 70mm x 1.6mm glass epoxy board. In case of exceeding this absolute maximum rating, increase the board size and copper area to prevent exceeding the Pd rating.

6. Recommended Operating Conditions

These conditions represent a range within which the expected characteristics of the IC can be approximately obtained. The electrical characteristics are guaranteed under the conditions of each parameter.

7. Inrush Current

When power is first supplied to the IC, it is possible that the internal logic may be unstable and inrush current may flow instantaneously due to the internal powering sequence and delays, especially if the IC has more than one power supply. Therefore, give special consideration to power coupling capacitance, power wiring, width of ground wiring, and routing of connections.

8. Operation Under Strong Electromagnetic Field

Operating the IC in the presence of a strong electromagnetic field may cause the IC to malfunction.

9. Testing on Application Boards

When testing the IC on an application board, connecting a capacitor directly to a low-impedance output pin may subject the IC to stress. Always discharge capacitors completely after each process or step. The IC's power supply should always be turned off completely before connecting or removing it from the test setup during the inspection process. To prevent damage from static discharge, ground the IC during assembly and use similar precautions during transport and storage.

10. Inter-pin Short and Mounting Errors

Ensure that the direction and position are correct when mounting the IC on the PCB. Incorrect mounting may result in damaging the IC. Avoid nearby pins being shorted to each other especially to ground, power supply and output pin. Inter-pin shorts could be due to many reasons such as metal particles, water droplets (in very humid environment) and unintentional solder bridge deposited in between pins during assembly to name a few.

Operational Notes - continued

11. Unused Input Pins

Input pins of an IC are often connected to the gate of a MOS transistor. The gate has extremely high impedance and extremely low capacitance. If left unconnected, the electric field from the outside can easily charge it. The small charge acquired in this way is enough to produce a significant effect on the conduction through the transistor and cause unexpected operation of the IC. So unless otherwise specified, unused input pins should be connected to the power supply or ground line.

12. Regarding the Input Pin of the IC

This monolithic IC contains P+ isolation and P substrate layers between adjacent elements in order to keep them isolated. P-N junctions are formed at the intersection of the P layers with the N layers of other elements, creating a parasitic diode or transistor. For example (refer to figure below):

When GND > Pin A and GND > Pin B, the P-N junction operates as a parasitic diode.
 When GND > Pin B, the P-N junction operates as a parasitic transistor.

Parasitic diodes inevitably occur in the structure of the IC. The operation of parasitic diodes can result in mutual interference among circuits, operational faults, or physical damage. Therefore, conditions that cause these diodes to operate, such as applying a voltage lower than the GND voltage to an input pin (and thus to the P substrate) should be avoided.

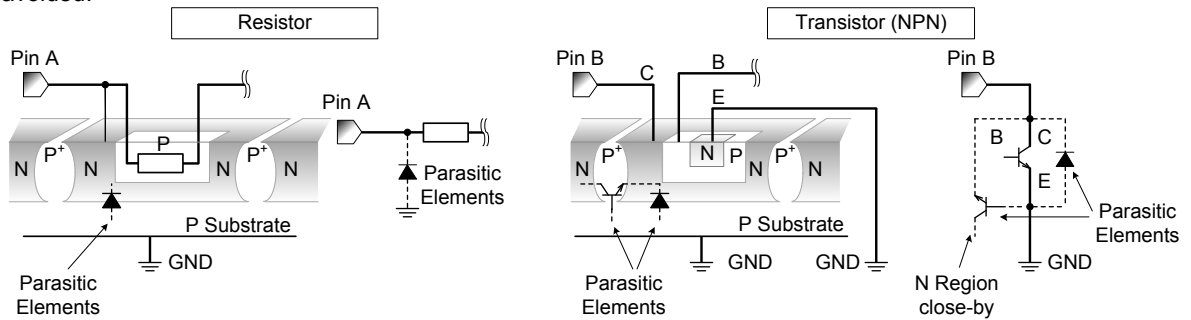

Figure 25. Example of monolithic IC structure

13. Ceramic Capacitor

When using a ceramic capacitor, determine the dielectric constant considering the change of capacitance with temperature and the decrease in nominal capacitance due to DC bias and others.

14. Disturbance light

In a device where a portion of silicon is exposed to light such as in a WL-CSP, IC characteristics may be affected due to photoelectric effect. For this reason, it is recommended to come up with countermeasures that will prevent the chip from being exposed to light.

Ordering Information

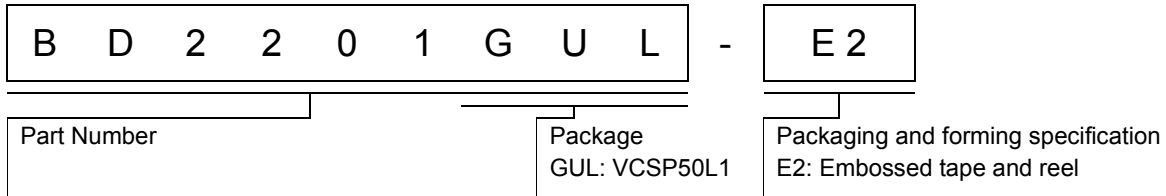
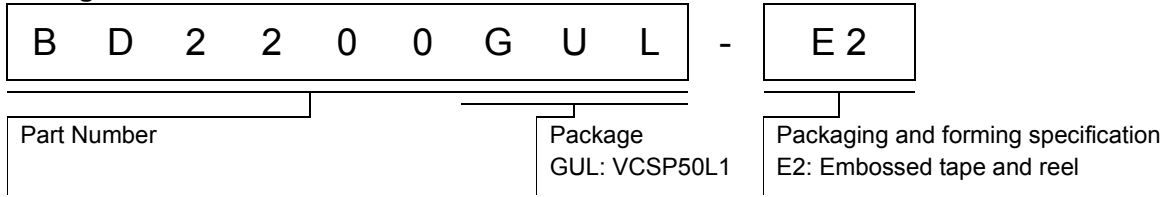

Marking Diagram

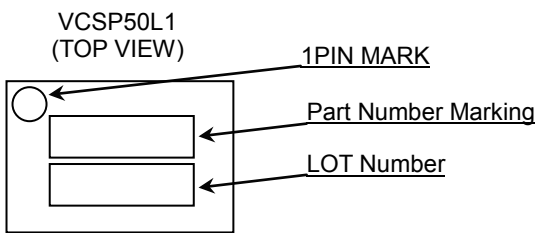

Part Number	Part Number Marking
BD2200GUL	ABA
BD2201GUL	ABU

Physical Dimension Tape and Reel Information

Package Name	VCSP50L1 (BD2200GUL)
--------------	----------------------

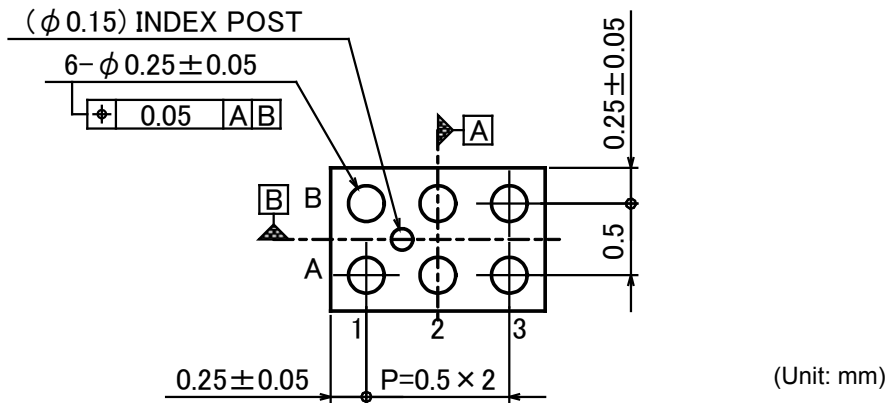
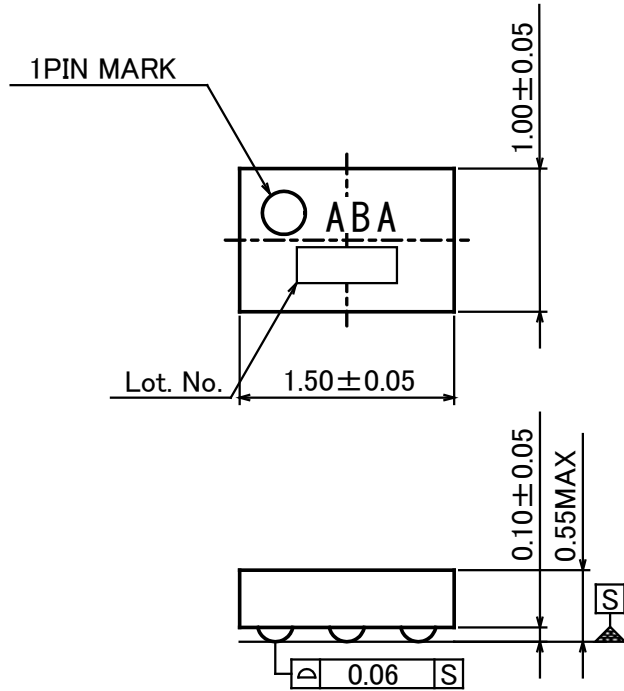

<Tape and Reel information>

Tape	Embossed carrier tape
Quantity	3000pcs
Direction of feed	E2 (The direction is the 1pin of product is at the upper left when you hold reel on the left hand and you pull out the tape on the right hand)

Reel

1pin

Direction of feed

*Order quantity needs to be multiple of the minimum quantity.

Physical Dimension Tape and Reel Information - continued

Package Name	VCSP50L1 (BD2201GUL)
--------------	----------------------

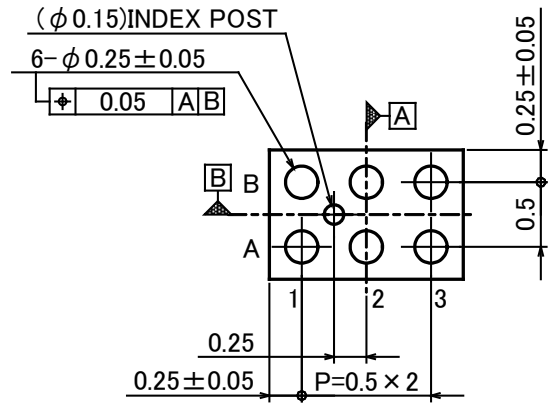
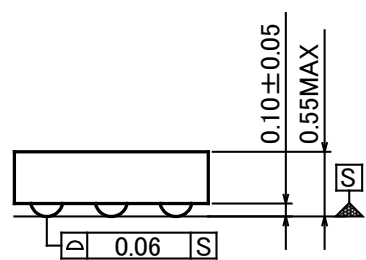
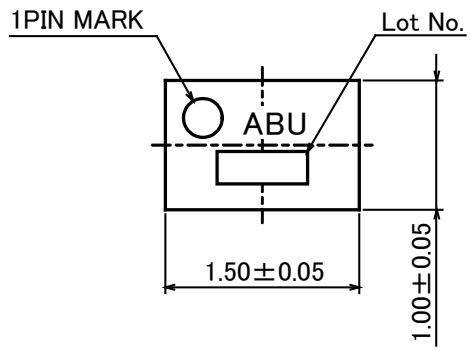

(Unit: mm)

<Tape and Reel information>

Tape	Embossed carrier tape
Quantity	3000pcs
Direction of feed	E2 (The direction is the 1pin of product is at the upper left when you hold reel on the left hand and you pull out the tape on the right hand)

*Order quantity needs to be multiple of the minimum quantity.

Revision History

Date	Revision	Changes
11.Mar.2013	001	New Release
21.Aug.2014	002	Applied the ROHM Standard Style and improved understandability.

Notice

Precaution on using ROHM Products

- Our Products are designed and manufactured for application in ordinary electronic equipments (such as AV equipment, OA equipment, telecommunication equipment, home electronic appliances, amusement equipment, etc.). If you intend to use our Products in devices requiring extremely high reliability (such as medical equipment ^(Note 1), transport equipment, traffic equipment, aircraft/spacecraft, nuclear power controllers, fuel controllers, car equipment including car accessories, safety devices, etc.) and whose malfunction or failure may cause loss of human life, bodily injury or serious damage to property ("Specific Applications"), please consult with the ROHM sales representative in advance. Unless otherwise agreed in writing by ROHM in advance, ROHM shall not be in any way responsible or liable for any damages, expenses or losses incurred by you or third parties arising from the use of any ROHM's Products for Specific Applications.

(Note1) Medical Equipment Classification of the Specific Applications

JAPAN	USA	EU	CHINA
CLASS III	CLASS III	CLASS II b	CLASS III
CLASS IV		CLASS III	

- ROHM designs and manufactures its Products subject to strict quality control system. However, semiconductor products can fail or malfunction at a certain rate. Please be sure to implement, at your own responsibilities, adequate safety measures including but not limited to fail-safe design against the physical injury, damage to any property, which a failure or malfunction of our Products may cause. The following are examples of safety measures:
 - Installation of protection circuits or other protective devices to improve system safety
 - Installation of redundant circuits to reduce the impact of single or multiple circuit failure
- Our Products are designed and manufactured for use under standard conditions and not under any special or extraordinary environments or conditions, as exemplified below. Accordingly, ROHM shall not be in any way responsible or liable for any damages, expenses or losses arising from the use of any ROHM's Products under any special or extraordinary environments or conditions. If you intend to use our Products under any special or extraordinary environments or conditions (as exemplified below), your independent verification and confirmation of product performance, reliability, etc. prior to use, must be necessary:
 - Use of our Products in any types of liquid, including water, oils, chemicals, and organic solvents
 - Use of our Products outdoors or in places where the Products are exposed to direct sunlight or dust
 - Use of our Products in places where the Products are exposed to sea wind or corrosive gases, including Cl₂, H₂S, NH₃, SO₂, and NO₂
 - Use of our Products in places where the Products are exposed to static electricity or electromagnetic waves
 - Use of our Products in proximity to heat-producing components, plastic cords, or other flammable items
 - Sealing or coating our Products with resin or other coating materials
 - Use of our Products without cleaning residue of flux (even if you use no-clean type fluxes, cleaning residue of flux is recommended); or Washing our Products by using water or water-soluble cleaning agents for cleaning residue after soldering
 - Use of the Products in places subject to dew condensation
- The Products are not subject to radiation-proof design.
- Please verify and confirm characteristics of the final or mounted products in using the Products.
- In particular, if a transient load (a large amount of load applied in a short period of time, such as pulse. is applied, confirmation of performance characteristics after on-board mounting is strongly recommended. Avoid applying power exceeding normal rated power; exceeding the power rating under steady-state loading condition may negatively affect product performance and reliability.
- De-rate Power Dissipation (Pd) depending on Ambient temperature (Ta). When used in sealed area, confirm the actual ambient temperature.
- Confirm that operation temperature is within the specified range described in the product specification.
- ROHM shall not be in any way responsible or liable for failure induced under deviant condition from what is defined in this document.

Precaution for Mounting / Circuit board design

- When a highly active halogenous (chlorine, bromine, etc.) flux is used, the residue of flux may negatively affect product performance and reliability.
- In principle, the reflow soldering method must be used; if flow soldering method is preferred, please consult with the ROHM representative in advance.

For details, please refer to ROHM Mounting specification

Precautions Regarding Application Examples and External Circuits

1. If change is made to the constant of an external circuit, please allow a sufficient margin considering variations of the characteristics of the Products and external components, including transient characteristics, as well as static characteristics.
2. You agree that application notes, reference designs, and associated data and information contained in this document are presented only as guidance for Products use. Therefore, in case you use such information, you are solely responsible for it and you must exercise your own independent verification and judgment in the use of such information contained in this document. ROHM shall not be in any way responsible or liable for any damages, expenses or losses incurred by you or third parties arising from the use of such information.

Precaution for Electrostatic

This Product is electrostatic sensitive product, which may be damaged due to electrostatic discharge. Please take proper caution in your manufacturing process and storage so that voltage exceeding the Products maximum rating will not be applied to Products. Please take special care under dry condition (e.g. Grounding of human body / equipment / solder iron, isolation from charged objects, setting of ionizer, friction prevention and temperature / humidity control).

Precaution for Storage / Transportation

1. Product performance and soldered connections may deteriorate if the Products are stored in the places where:
 - [a] the Products are exposed to sea winds or corrosive gases, including Cl₂, H₂S, NH₃, SO₂, and NO₂
 - [b] the temperature or humidity exceeds those recommended by ROHM
 - [c] the Products are exposed to direct sunshine or condensation
 - [d] the Products are exposed to high Electrostatic
2. Even under ROHM recommended storage condition, solderability of products out of recommended storage time period may be degraded. It is strongly recommended to confirm solderability before using Products of which storage time is exceeding the recommended storage time period.
3. Store / transport cartons in the correct direction, which is indicated on a carton with a symbol. Otherwise bent leads may occur due to excessive stress applied when dropping of a carton.
4. Use Products within the specified time after opening a humidity barrier bag. Baking is required before using Products of which storage time is exceeding the recommended storage time period.

Precaution for Product Label

QR code printed on ROHM Products label is for ROHM's internal use only.

Precaution for Disposition

When disposing Products please dispose them properly using an authorized industry waste company.

Precaution for Foreign Exchange and Foreign Trade act

Since our Products might fall under controlled goods prescribed by the applicable foreign exchange and foreign trade act, please consult with ROHM representative in case of export.

Precaution Regarding Intellectual Property Rights

1. All information and data including but not limited to application example contained in this document is for reference only. ROHM does not warrant that foregoing information or data will not infringe any intellectual property rights or any other rights of any third party regarding such information or data. ROHM shall not be in any way responsible or liable for infringement of any intellectual property rights or other damages arising from use of such information or data.:
2. No license, expressly or implied, is granted hereby under any intellectual property rights or other rights of ROHM or any third parties with respect to the information contained in this document.

Other Precaution

1. This document may not be reprinted or reproduced, in whole or in part, without prior written consent of ROHM.
2. The Products may not be disassembled, converted, modified, reproduced or otherwise changed without prior written consent of ROHM.
3. In no event shall you use in any way whatsoever the Products and the related technical information contained in the Products or this document for any military purposes, including but not limited to, the development of mass-destruction weapons.
4. The proper names of companies or products described in this document are trademarks or registered trademarks of ROHM, its affiliated companies or third parties.

General Precaution

1. Before you use our Products, you are requested to carefully read this document and fully understand its contents. ROHM shall not be in any way responsible or liable for failure, malfunction or accident arising from the use of any ROHM's Products against warning, caution or note contained in this document.
2. All information contained in this document is current as of the issuing date and subject to change without any prior notice. Before purchasing or using ROHM's Products, please confirm the latest information with a ROHM sales representative.
3. The information contained in this document is provided on an "as is" basis and ROHM does not warrant that all information contained in this document is accurate and/or error-free. ROHM shall not be in any way responsible or liable for any damages, expenses or losses incurred by you or third parties resulting from inaccuracy or errors of or concerning such information.

Mouser Electronics

Authorized Distributor

Click to View Pricing, Inventory, Delivery & Lifecycle Information:

[ROHM Semiconductor:](#)

[BD2201GUL-E2](#) [BD2200GUL-E2](#)