

Cree® PLCC4 1 in 1 SMD LED CLM2D-RCC/ACC



PRODUCT DESCRIPTION

SMD LEDs is packaged in the industry standard package. These LEDs have high reliability performance and are designed to work under a wide range of environmental conditions.

This high reliability feature makes them ideally suited to be used under Architectural lighting application conditions

These LEDs are suited for channel letter, or Architectural lighting applications. Cree has been certified in accordance with ISO/ IATF16949.

FEATURES

- Size (mm): 3.2 x 2.8
- Color and Typical Dominant Wavelength:
Red (619 - 624nm)
Amber (584 - 596nm)
- Luminous Intensity (mcd)
CLM2D-RCC: (2800 - 9000)
CLM2D-ACC: (2800 - 9000)
- Moisture Sensitivity Level: 5a
- Lead-Free
- RoHS Compliant
- Untinted Diffused Lens

APPLICATIONS

- Channel Letter
- Architectural Lighting

ABSOLUTE MAXIMUM RATINGS ($T_A = 25^\circ\text{C}$)

Items	Symbol	Absolute Maximum Rating		Unit
		Red	Amber	
Forward Current	I_F	70		mA
Peak Forward Current ^{Note}	I_{FP}	200		mA
Reverse Voltage	V_R	5		V
Power Dissipation	P_D	182		mW
Operation Temperature	T_{opr}	-40 ~ +100		$^\circ\text{C}$
Storage Temperature	T_{stg}	-40 ~ +100		$^\circ\text{C}$
Junction Temperature	T_J	110		$^\circ\text{C}$
Junction/Ambient	R_{THJA}	250		$^\circ\text{C}/\text{W}$
Junction/Solder Point	R_{THJS}	100		$^\circ\text{C}/\text{W}$
Electrostatic Discharge Classification(MIL-STD-883E)	ESD	Class 2		

Note: Pulse width ≤ 0.1 msec, duty $\leq 1/10$.

TYPICAL ELECTRICAL & OPTICAL CHARACTERISTICS ($T_A = 25^\circ\text{C}$)

Characteristics	Color	Symbol	Condition	Unit	Minimum	Typical	Maximum
Forward Voltage	Red	V_F	$I_F = 20$ mA	V		2.0	2.6
	Amber	V_F	$I_F = 20$ mA	V		2.1	2.6
Reverse Current	Red/Amber	I_R	$V_R = 5$ V	μA			10
Dominant Wavelength	Red	λ_D	$I_F = 20$ mA	nm	619	621	624
	Amber	λ_D	$I_F = 20$ mA	nm	584	590	596
Luminous Intensity	Red	I_V	$I_F = 20$ mA	mcd	2800	5000	
	Amber	I_V	$I_F = 20$ mA	mcd	2800	5200	

Note: Continuous reverse voltage can cause LED damage.

INTENSITY BIN LIMIT ($I_F = 20 \text{ mA}$)

Red

Bin Code	Min. (mcd)	Max. (mcd)
Ya	2800	3550
Yb	3550	4500
Z0	4500	5600
A0	5600	7100
B0	7100	9000

Amber

Bin Code	Min. (mcd)	Max. (mcd)
Ya	2800	3550
Yb	3550	4500
Z0	4500	5600
A0	5600	7100
B0	7100	9000

Tolerance of measurement of luminous intensity is $\pm 10\%$.

COLOR BIN LIMIT ($I_F = 20 \text{ mA}$)

Red

Bin Code	Min. (nm)	Max. (nm)
RB	619	624

Amber

Bin Code	Min. (nm)	Max. (nm)
A2	584	587
A3	587	590
A4	590	593
A5	593	596

Tolerance of measurement of dominant wavelength is $\pm 1 \text{ nm}$.

ORDER CODE TABLE*

Color	Kit Number	Luminous Intensity (mcd)		Dominant Wavelength				Package
		Min.	Max.	Color Bin	Min.(nm)	Color Bin	Max.(nm)	
Red	CLM2D-RCC-CYaB0BB3	2800	9000	RB	619	RB	624	Reel
Red	CLM2D-RCC-CYbB0BB3	3550	9000	RB	619	RB	624	Reel
Red	CLM2D-RCC-CZ0B0BB3	4500	9000	RB	619	RB	624	Reel

Color	Kit Number	Luminous Intensity (mcd)		Dominant Wavelength				Package
		Min.	Max.	Color Bin	Min.(nm)	Color Bin	Max.(nm)	
Amber	CLM2D-ACC-CYaB0253	2800	9000	A2	584	A5	596	Reel
Amber	CLM2D-ACC-CYbB0253	3550	9000	A2	584	A5	596	Reel
Amber	CLM2D-ACC-CZ0B0343	4500	9000	A3	587	A4	593	Reel

Notes:

1. The above kit numbers represent order codes that include multiple intensity-bin and color-bin codes. Only one intensity-bin code and one color-bin code will be shipped on each bulk. Single intensity-bin code and single color-bin codes will not be orderable.
2. Please refer to the "Cree LED Lamp Reliability Test Standards" document #1 for reliability test conditions.
3. Please refer to the "Cree LED Lamp Soldering & Handling" document #2 for information about how to use this LED product safely.

#1: Refer to http://www.cree.com/led-components/media/documents/LED_Lamp_Reliability_Test_Standard.pdf

#2: Refer to <http://www.cree.com/led-components/media/documents/sh-HB.pdf>

GRAPHS

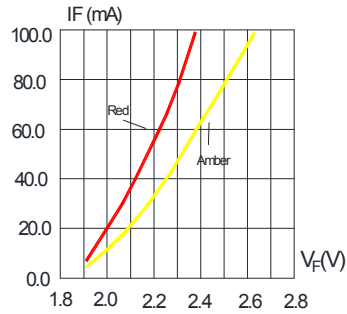

FIG.1 FORWARD CURRENT VS. FORWARD VOLTAGE.

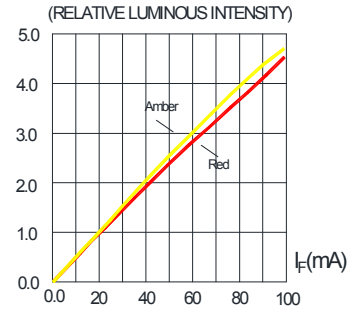

FIG.2 RELATIVE LUMINOUS INTENSITY VS. FORWARD CURRENT

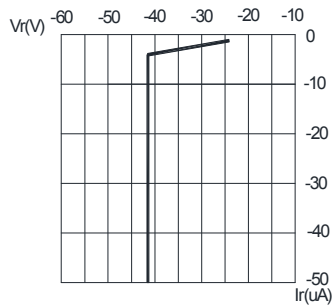

FIG.3 RED&AMBER REVERSE CURRENT VS. REVERSE VOLTAGE.

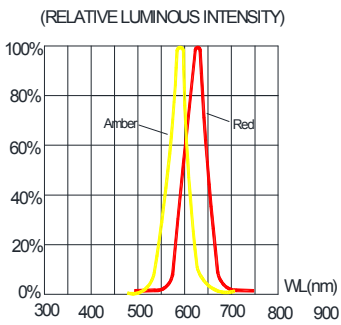

FIG.4 RELATIVE LUMINOUS INTENSITY VS. WAVELENGTH.

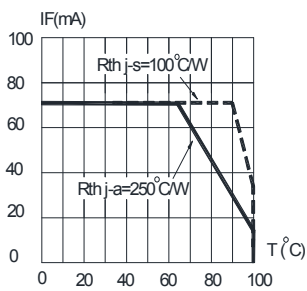

FIG.5 RED&AMBER MAXIMUM FORWARD DC CURRENT VS AMBIENT TEMPERATURE (Tjmax=110°C)

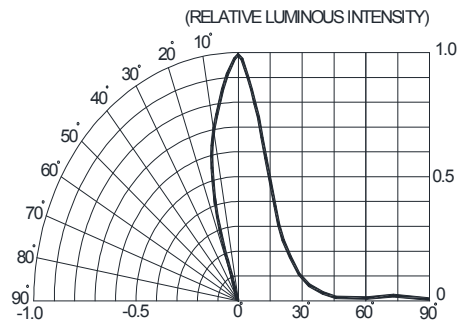
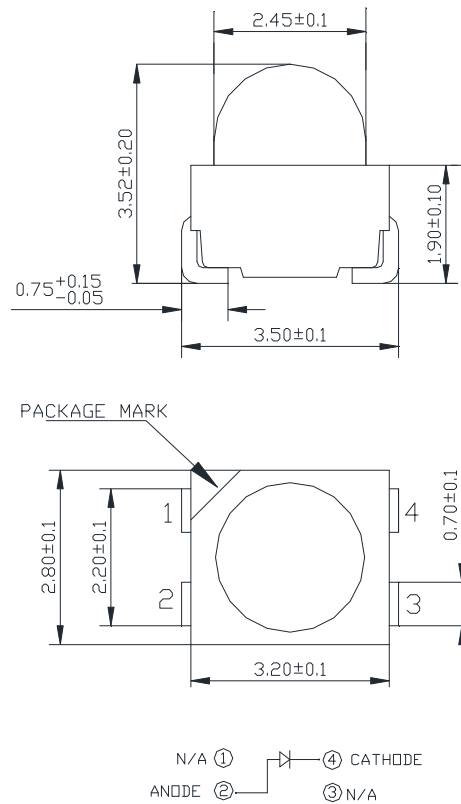

FIG.6 FAR FIELD PATTERN

The above data are collected from statistical figures that do not necessarily correspond to the actual parameters of each single LED. Hence, these data will be changed without further notice.

MECHANICAL DIMENSIONS

All dimensions are in mm.



NOTES

RoHS Compliance

The levels of RoHS-restricted materials in this product are below the maximum concentration values (also referred to as the threshold limits) permitted for such substances, or are used in an exempted application in accordance with EU Directive 2011/65/EC (RoHS2), as implemented by EU member states on January 2, 2013 and amended on March 31, 2015 by EU Directive 2015/863/EU.

RoHS Declarations for this product can be obtained from your Cree representative or from the Product Ecology section of the Cree website.

Vision Advisory Claim

Users should be cautioned not to stare at the light of this LED product. The bright light can damage the eye.

KIT NUMBER SYSTEM

Cree LED lamps are tested and sorted into performance bins. A bin is specified by ranges of color, forward voltage, and brightness. Sorted LEDs are packaged for shipping in various convenient options. Please refer to the "Cree LED Lamp Packaging Standard" document for more information about shipping and packaging options.

Cree LEDs are sold by order codes in combinations of bins called kits. Order codes are configured in the following manner:



REFLOW SOLDERING

- The CLM2D-RCC/ACC is rated as a MSL 5a product.
- The recommended floor life out of bag is 24hrs.
- The temperature profile is as below.



Use only with CLM2D-RCC/ACC

Solder
Average ramp-up rate = 4°C/s max
Preheat temperature = 150°C ~200°C
Preheat time = 120s max
Ramp-down rate = 6°C/s max
Peak temperature = 235°C max
Time within 5°C of actual Peak Temperature = 10s max
Duration above 217°C is 45s max

Refer to "<http://www.cree.com/led-components/media/documents/sh-HB.pdf>" for soldering & handling details.

NOTES

- The packaging sizes of these SMD products are very small and the resin is still soft after solidification. Users are required to handle with care. Never touch the resin surface of SMD products.
- To avoid damaging the product's surface and interior device, it is recommended to choose a special nozzle to pick up the SMD products during the process of SMT production. If handling is necessary, take special care when picking up these products. The following method is necessary:



PACKAGING

- The boxes are not water resistant and they must be kept away from water and moisture.
- The LEDs are packed in cardboard boxes after packaging in normal or anti-electrostatic bags.
- Cardboard boxes will be used to protect the LEDs from mechanical shocks during transportation.
- The reel pack is applied in SMD LED.
- Max 2300 pcs per reel.

