

コイン形二酸化マンガンリチウム電池
Coin manganese dioxide lithium batteries

CR2450X

■外形寸法 Dimensions(mm)

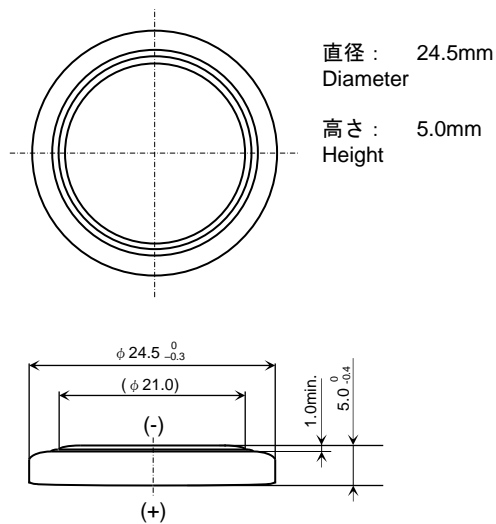

(Unit : mm)

■定格 Specifications

公称電圧 Nominal Voltage	3 V
公称容量 (終止電圧 2.0V) Nominal Capacity (2.0V cutoff)	600 mAh
推奨連続放電電流値 (容量利用率高) Recommended Continuous Discharge Current (High capacity usage rate)	≤1 mA
最大パルス放電電流(mA) *DOD50%時, 23°C, パルス長さ3sec, 2V以上 Maximum Pulse Discharge current (mA) *Assumption : Current to keep higher than 2V at 50% discharge with 23°C and pulse length 3sec.	30mA
標準質量 Weight	6.2 g
使用温度範囲 Operating Temperature	-40 ~ +85°C

用途 Applications

- 車載
 - ・タイヤ空気圧監視システム(TPMS)
 - ・スマートキー/キーレスエントリ
 - ・ETC (Electronic Toll Collection System) リーダ
 - ・ドライブカウンタ
- IoT / その他
 - ・スマートメータ
 - ・FA制御機器
 - ・トラッキングデバイス/センサーノード
- Automotive
 - ・TPMS(Tire Pressure Monitoring System)
 - ・Smart Key/Keyless entry
 - ・Toll Collection Device
 - ・Drive counter
- IoT / Other
 - ・Factory Automation Instruments
 - ・Tracking devices/Sensor node

■放電温度特性

Discharge Temperature Characteristics

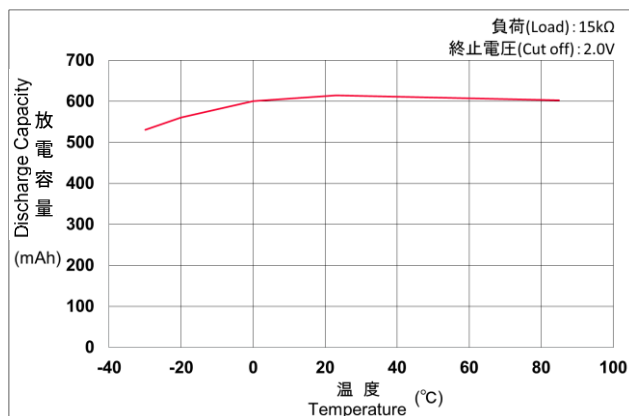

■保存特性

Storage Characteristic

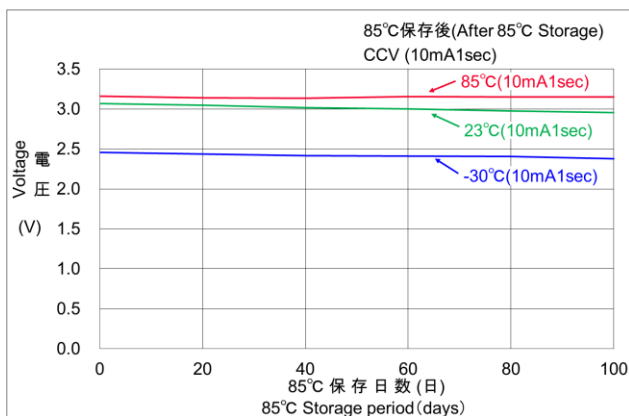

■放電負荷特性

Discharge Characteristics by Load

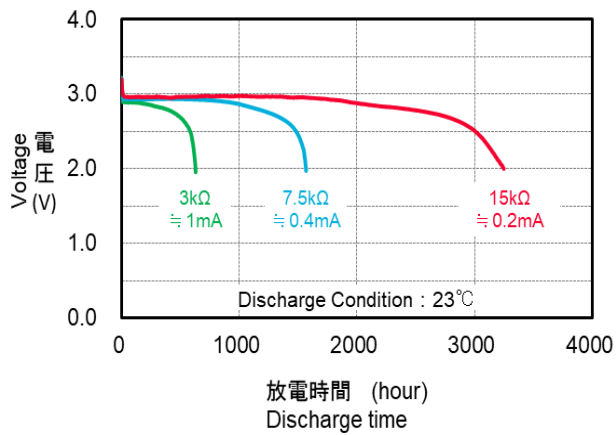

■放電温度特性

Discharge Characteristics by Temperature

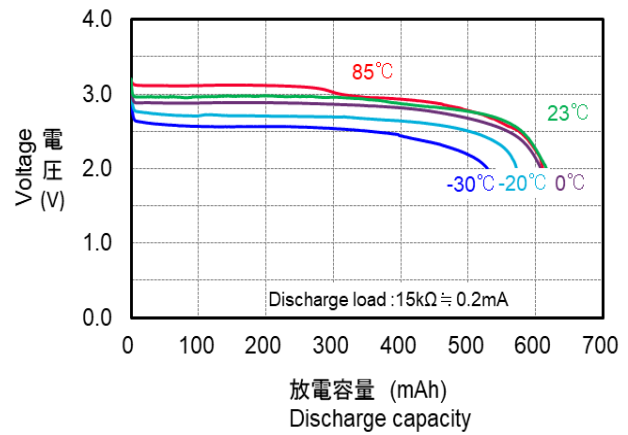

■閉路電圧特性

Closed Circuit Voltage by Temperature

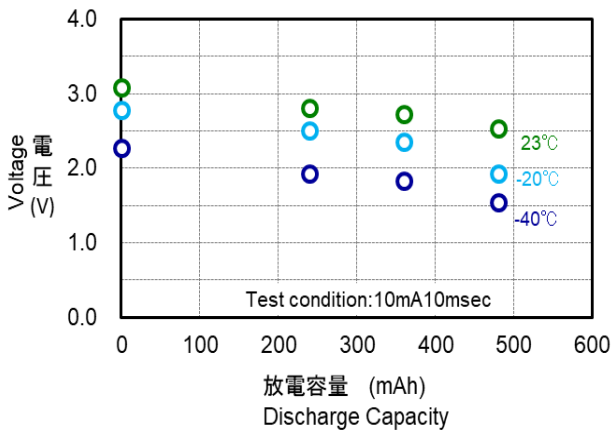

■内部抵抗

Impedance by Temperature

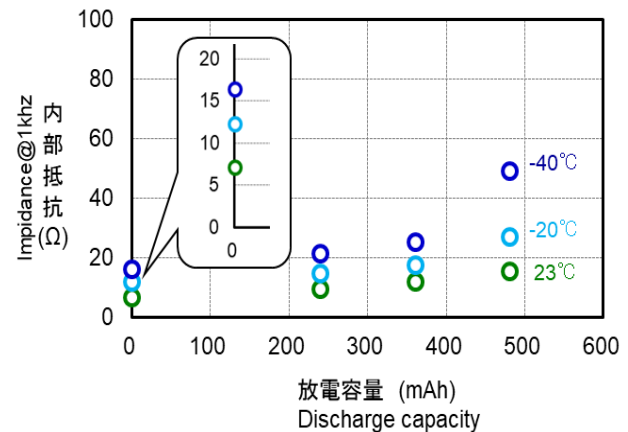

■自己放電特性

Self Discharge Characteristic by Temperature

注: 20°C未満の自己放電率は 20°Cと同じ自己放電率になります。
 Note: The self-discharge rate of less than 20°C shows the same self-discharge rate as 20°C.

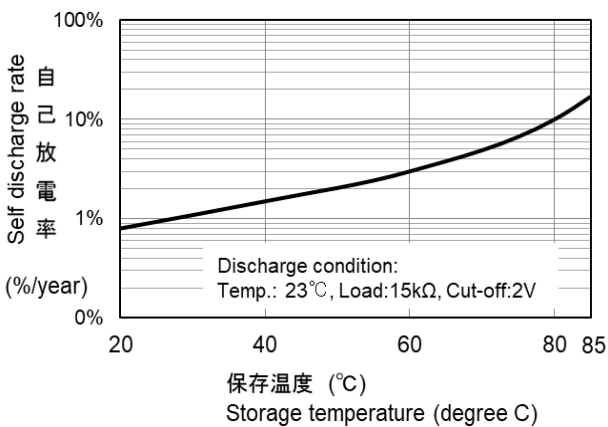

*記載のデータ及び数値は、参考値であり保証値ではありません。
 *Data is not guaranteed, and is provided for reference purposes