

# Preliminary



**SF2251E**

**1600 MHz  
SAW Filter**

- *Low-loss RF SAW Filter*
- *3.0 x 3.0 x 1.4 mm Surface-mount Case*
- *No Matching Required for 50Ω Operation*
- *Complies with Directive 2002/95/EC (RoHS)*



## Absolute Maximum Ratings

Rating	Value	Units
Incident Power in Passband	+10	dBm
DC Voltage on any Non-ground Terminal	3	VDC
Operating Temperature Range	-55 to +85	°C
Storage Temperature Range in Tape and Reel	-55 to +95	°C
Maximum Soldering Profile, 5 cycles/10 seconds maximum	265	°C

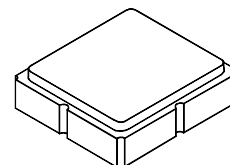

**SM3030-6**

## Electrical Characteristics

Characteristic	Sym	Notes	Min	Typ	Max	Units
Center Frequency	$f_c$			1600		MHz
Insertion Loss, 1580 to 1620 MHz	IL			3.15	5.00	dB
1500 MHz Attenuation Referenced to 0 dB			45	64		dB
1700 MHz Attenuation Referenced to 0 dB			40	47		dB
Terminating Source Impedance	$Z_s$			50		Ω
Terminating Load Impedance	$Z_L$			50		Ω
Input/Output Impedance Match	No matching network required for 50 ohm source/load					
Case Style	SM3030-6					
Lid Symbolization	992					



**CAUTION: Electrostatic Sensitive Device. Observe precautions for handling.**

**Notes:**

1. US and international patents may apply.
2. RFM, stylized RFM logo, and RF Monolithics, Inc. are registered trademarks of RF Monolithics, Inc.

# Matching Circuit

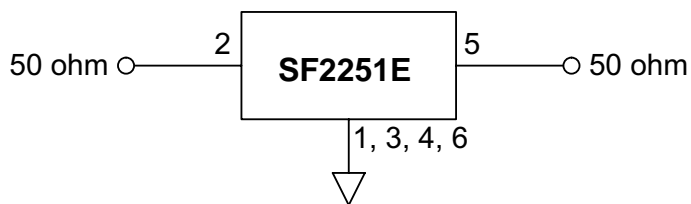

# Frequency Response Plots

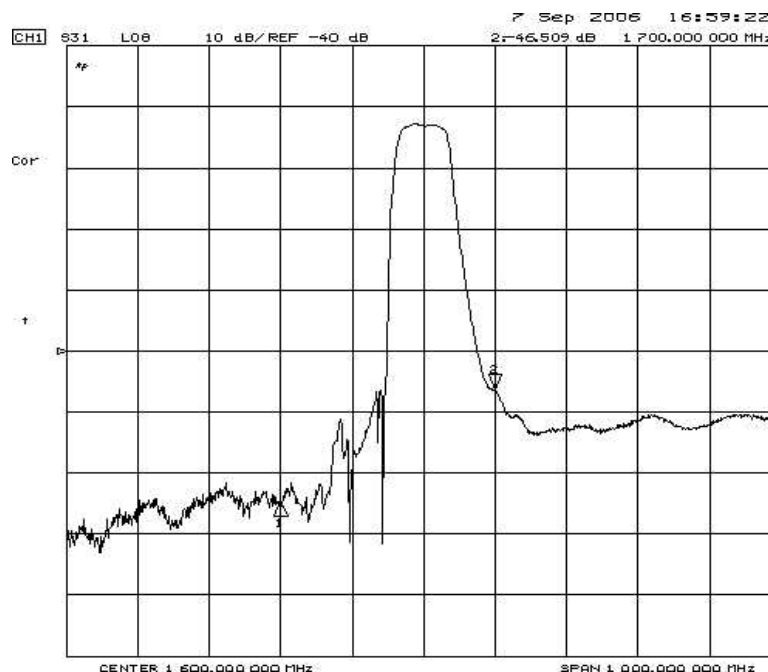
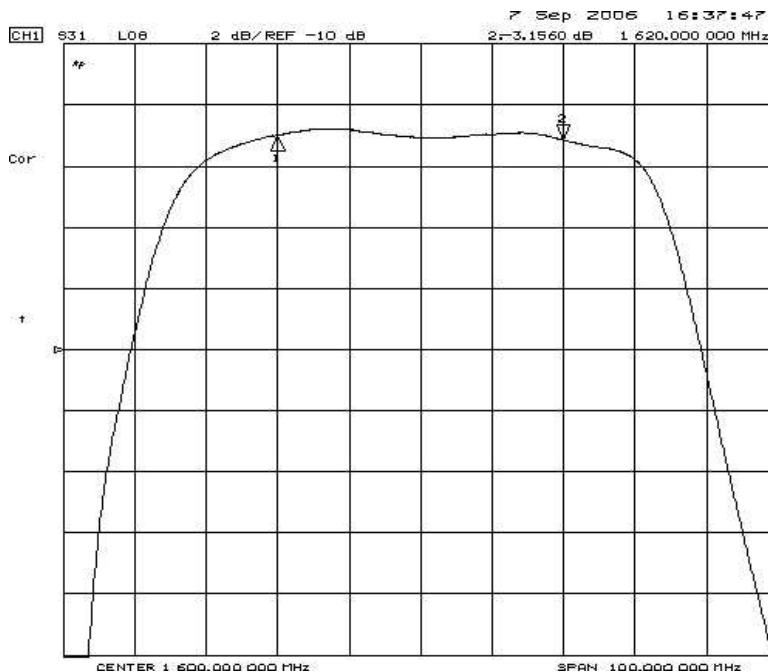

# Input/Output Impedance Plots

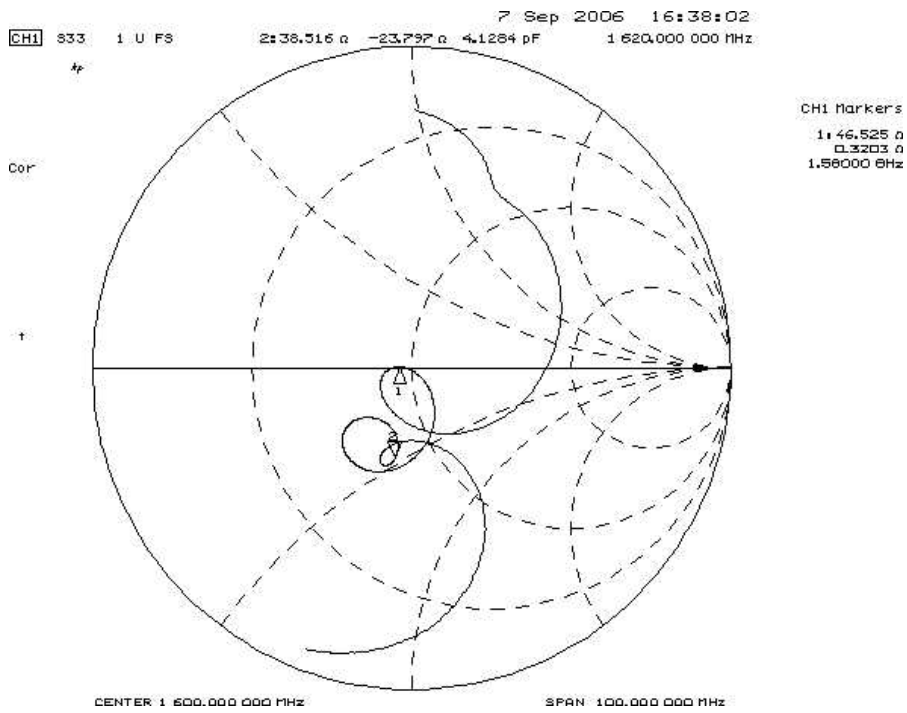
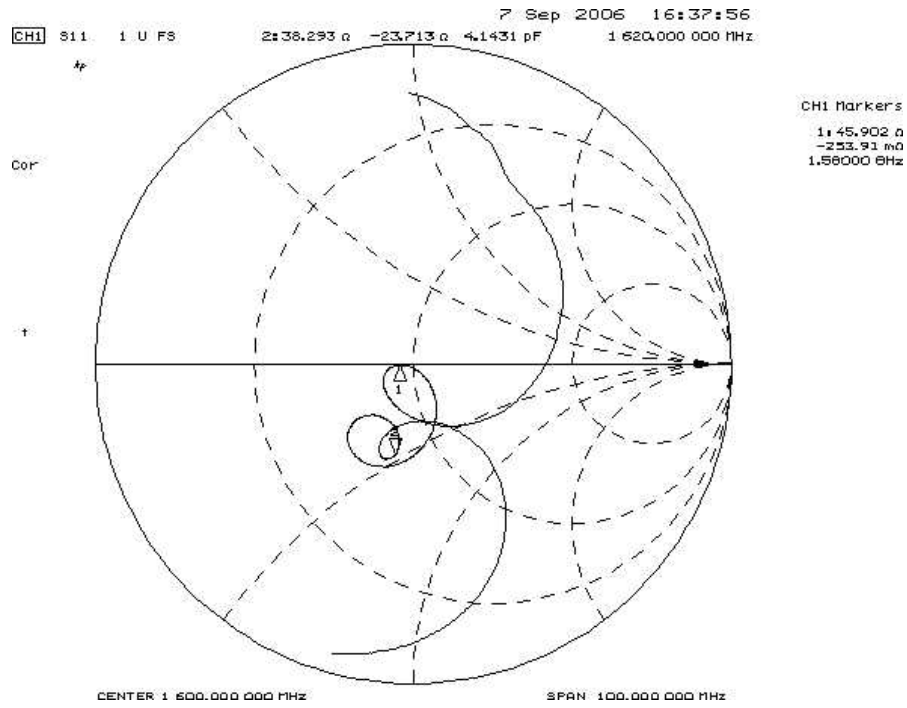

## 6-Terminal Ceramic Surface-Mount Case 3.0 X 3.0 mm Nominal Footprint

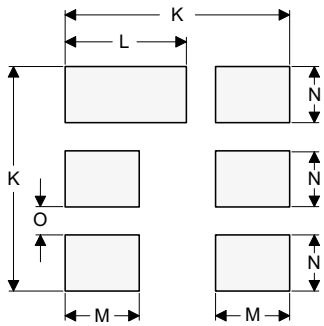
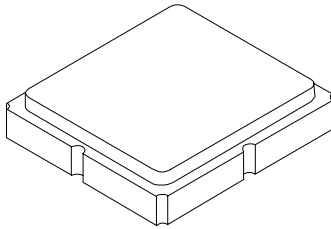

**PCB Footprint Top View**

### Case and PCB Footprint Dimensions

Dimension	mm			Inches		
	Min	Nom	Max	Min	Nom	Max
A	2.87	3.00	3.13	0.113	0.118	0.123
B	2.87	3.00	3.13	0.113	0.118	0.123
C	1.12	1.25	1.38	0.044	0.049	0.054
D	0.77	0.90	1.03	0.030	0.035	0.040
E	2.67	2.80	2.93	0.105	0.110	0.115
F	1.47	1.60	1.73	0.058	0.063	0.068
G	0.72	0.85	0.98	0.028	0.033	0.038
H	1.37	1.50	1.63	0.054	0.059	0.064
I	0.47	0.60	0.73	0.019	0.024	0.029
J	1.17	1.30	1.43	0.046	0.051	0.056
K		3.20			0.126	
L		1.70			0.067	
M		1.05			0.041	
N		0.81			0.032	
O		0.38			0.015	

### Case Materials

Materials	
Solder Pad Plating	0.3 to 1.0 $\mu\text{m}$ Gold over 1.27 to 8.89 $\mu\text{m}$ Nickel
Lid Plating	2.0 to 3.0 $\mu\text{m}$ Nickel
Body	$\text{Al}_2\text{O}_3$ Ceramic
Pb Free	

### TOP VIEW

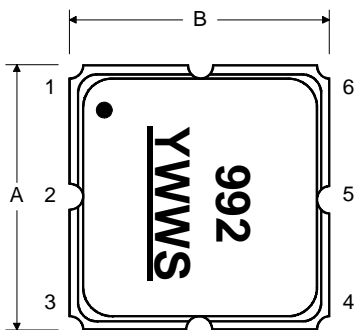

### BOTTOM VIEW

