

## CONTROL PANEL WITH FONTS, GRAPHICS COMMANDS AND MACROS

**Integrated Touch panel**



EA KIT240-7CTP  
Dimensions 144x104mm

### TECHNICAL DATA

- \* LCD GRAPHIC DISPLAY WITH MANY GRAPHICS FUNCTIONS AND FONTS
- \* 240x128 PIXELS WITH CFL ILLUMINATION, BLUE NEGATIVE (RECOMMENDED)
- \* 240x128 PIXELS WITH LED ILLUMINATION YELLOW/GREEN
- \* 240x128 PIXELS WITH WHITE LED ILLUMINATION, BLUE NEGATIVE MODE
- \* INTEGRATED TOUCH PANEL WITH 10x6 FIELDS (ANTI-GLARE, SCRATCH-RESISTANT)
- \* FONT ZOOM OF approx. 2mm VIA approx. 5mm UP TO approx. 50mm
- \* SUPPLY VOLTAGE 5V/700mA (CFL)/1200mA (LED) OR OPTIONALLY 9..35V
- \* RS-232 OR ALTERNATIVELY RS-422 WITH BAUD RATES 1200..115200
- \* POSITIONING ACCURATE TO THE PIXEL WITH ALL FUNCTIONS
- \* PROGRAMMING BY MEANS OF HIGH-LEVEL LANGUAGE-TYPE COMMANDS:
- \* STRAIGHT LINE, POINT, AREA, AND/OR/EXOR, BAR GRAPH...
- \* UP TO 256 MACROS PROGRAMMABLE
- \* 4 CLIPBOARD FUNCTIONS, PULL-DOWN MENUS

### ACCESSORIES

- \* INTEGRATED ALUMINUM BEZEL: BLACK (EA 0FP240-7SW) OR BLUE (-7BL)
- \* FLOPPY DISK FOR MACRO PROGRAMMING (PC DOS): EA DISK240
- \* CABLE (1.5m) FOR CONNECTION TO 9-PIN SUB-D (RS-232 FEMALE): EA KV24-9B

With  
integrated bezel



### ORDER DESIGNATION

240x128 DOT SWITH TOUCH PANEL, CFL ILLUM., BLUE NEGATIVE	EA KIT240-7CTP
240x128 DOT SWITH TOUCH PANEL, LED ILLUMINATION, Y/G	EA KIT240-7LEDTP
240x128 DOT SWITH TOUCH PANEL, LED ILLUMINATION, WHITE	EA KIT240-7LWTP
240x128 DOT SWITH CFL ILLUMINATION, BLUE NEGATIVE	EA KIT240-7C
240x128 DOT SWITH LED ILLUMINATION, Y/G	EA KIT240-7LED
240x128 DOT SWITH LED ILLUMINATION, WHITE	EA KIT240-7LW
SUPPLY VOLTAGE 9..35V INSTEAD OF 5V	EA OPT-9/35V
RS-422 INTERFACE INSTEAD OF RS-232	EA OPT-RS4224
8 DIGITAL INPUTS AND 8 OUTPUTS WITH OPTOCOUPLER	EA OPT-OPTO8I80

### GENERAL

The EA KIT240 graphics kit is a fully assembled control and operating unit with a variety of integrated functions. The display has very compact dimensions and offers excellent super-twist contrast, which means the unit can be put into operation immediately. It is controlled via the standard RS-232 or RS-422 interface. In addition to complete graphics routines for display output, the graphics kit also contains a wide variety of fonts. Graphics command similar to those used in high-level programming languages are used for programming. There is thus no longer any need for the time-consuming programming of character sets and graphics routines. The ease of use offered by macros and input via touch panel make it a real power display.

### DISPLAYVERSIONS

- CFL-Backlight EA KIT240-7CTP: blue background with white characters. Extreme bright and with high contrast. Life time (MTBF) for backlight 10,000~20,000h. BBacklight unit is as a spare part available (ordering code EA CFL240-7). Current consumption typ. 450 mA.
- LED-Backlight EAKIT240-7LWTP: blue background with white characters. Bright and with high contrast. Life time for half of brightness: 20,000~30,000h. Current consumption typ. 250 mA.
- LED-Backlight EA KIT240-7LEDTP: Yellow/green background with black characters. Good contrast, Life time (MTBF) 100,000h. Current consumption typ. 1200 mA.

### HARDWARE

The graphics kit is designed for an operating voltage of +5V. A supply voltage of 9..35V is also possible. Serial asynchronous data transfer is carried out in RS-232 or RS-422 format. The transmission format is set permanently to 8 data bits, 1 stop bits, and no parity. A transimssion rate of between 1200 and 115,200 baud can be selected by means of DIP switches. RTS and CTS handshake lines are available.

Data format:

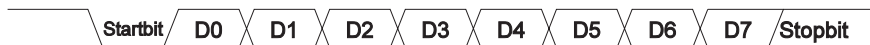

### TOUCH PANEL

The EA KIT240-7CTP and -7LEDTP versions are equipped with an integrated touch panel. You can make entries and choose menu settings by touching the display. The labeling of the "keys" is flexible and can also be changed during runtime (different languages, icons). The drawing of the individual "keys" and the labeling or grouping of several fields is handled by the integrated software.

### SOFTWARE

The graphic kits are programmed by means of commands such as *Draw a rectangle from (0,0) to (64, 15)*. No additional software or drivers are required. Strings can be placed with **pixel accuracy**. Text and graphics can be combined at any time. Up to 16 different character sets can be used. Thus, when the 8-times zoom is used with character set 16x8, the words and numbers fill the screen.

### ACCESSORIES

#### Front panel for mounting

A front panel made of anodized aluminum is available as an accessory. This allows the graphics kit to be mounted without any screws visible. Installing it is child's play. The EA 0FP240-7 front panel is available in black (SW) and blue (BL).

#### Floppy disk for creating macros

A floppy disk (EA DISK240) is required for macro programming\*). This converts the commands entered in a text file into a code that can be read by the graphics kit, and programs them into the EEPROM.

#### Cable for PC

To enable simple connection to PCs (macro programming), we provide a 1.5m cable and a 9-pin SUB-D female connector (EA KV24-9B). Simply insert it into COM 1 or COM 2 and get started. Note: The cable is not suitable for the RS-422 version (EA OPT-RS4224).

## ELECTRONIC ASSEMBLY

### EXTERNAL KEYBOARD

A keyboard (anything from individual keys to a 10x6 matrix keyboard) can be connected at the plug-in connection. The connected keys are debounced by means of software. Please note that it is only possible to connect an external keyboard to versions without an integrated touch panel.

Each key is switched between an output and an input. Each input has a 100kΩ pullup. Up to 6 keys can be connected at each output.

#### Transmitting the keystrokes

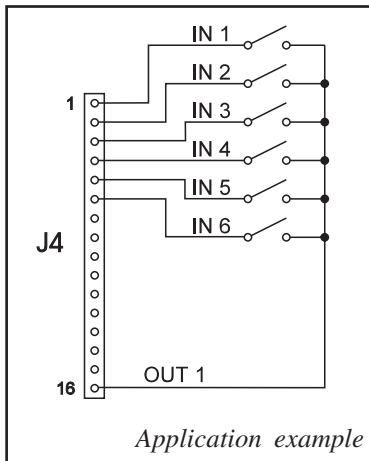

At each keystroke, the associated key number (1..60) is transmitted. The release of the key is not transmitted. If the release of the key is to be transmitted as well, this can be done by defining touch macro no. 0. The automatic keyboard scan can be deactivated by means of the command "ESC T A 0".

The key number can be determined as follows: **Key number = (output - 1) \* 10 + input** (output: a number between 1 and 10; input: a number between 1 and 6).

Note: If the handshake line (e.g. CTS) does not permit transmission, keystrokes can be lost.

J4 matrix keyboard connection		
Pin	Symbol	Function
1	IN 1	Input line 1
2	IN 2	Input line 2
3	IN 3	Input line 3
4	IN 4	Input line 4
5	IN 5	Input line 5
6	IN 6	Input line 6
7	OUT 10	Output column 10
8	OUT 9	Output column 9
9	OUT 8	Output column 8
10	OUT 7	Output column 7
11	OUT 6	Output column 6
12	OUT 5	Output column 5
13	OUT 4	Output column 4
14	OUT 3	Output column 3
15	OUT 2	Output column 2
16	OUT 1	Output column 1

### TOUCH PANEL (EA KIT240-7CTP AND -7LEDTP ONLY)

Versions EA KIT240-7CTP and -7LEDTP are supplied with an integrated touch panel with 60 fields. The graphics kit offers convenient commands supporting this touch panel. It is possible, for example, to group a number of touch fields to form a single large key and then draw and label the key. You can also assign a record code (1..255) to the key you have defined. If a return code of 0 is assigned, the key is disabled and has no effect when it is pressed.

When the touch keys are touched, they can be automatically inverted and a tone can sound, indicating they have been touched. At the same time, the defined return code of the key is transmitted via the serial interface, or an internal touch macro with the number of the return code is started.

#### Example:

Definition of a key from field 13 to 25 with the return code 65='A' and the text "STOP". Note: Before individual keys are defined, all fields should be disabled by means of "ESC T R".

1	2	3	4	5	6	7	8	9	10
11	12	13	14	15	16	17	18	19	20
21	22	23	24	25	26	27	28	29	30
31	32	33	34	35	36	37	38	39	40
41	42	43	44	45	46	47	48	49	50
51	52	53	54	55	56	57	58	59	60

Example	Codes to be output										Note		
For compiler	#TH 13, 25, 'A', 2, "STOP"										The end code 0 is not specified here		
As ASCII	ESC	T	H	.	.	A	.	S	T	O	P	.	The dots '.' stand for ASCII characters that are not to be displayed
In hex	\$1B	\$54	\$48	\$0D	\$19	\$41	\$02	\$53	\$54	\$4F	\$50	\$00	
In decimal	27	84	72	13	25	65	2	83	84	79	80	0	
Command ID	Initiation of touch command	Horizontal labeling	Upper left touch field	Lower right touch field	Return code	Drawing of key with frame						End of text ID	



## BAUD RATES

The baud rate can be set by means of the 3 DIP switches on the left. 9,600 baud is set at the factory (DIP 3 ON). Please note that the internal data buffer only holds 22 bytes. It is therefore imperative that the RTS handshake line be queried (a level of +10V means data can be accepted; a level of -10V means the display is busy). The data format is fixed at 8 data bits, 1 stop bit and no parity.

Baud rates			
DIP switches			Data format 8,N,1
1	2	3	
ON	ON	ON	1200
OFF	ON	ON	2400
ON	OFF	ON	4800
OFF	OFF	ON	9600
ON	ON	OFF	19200
OFF	ON	OFF	38400
ON	OFF	OFF	57600
OFF	OFF	OFF	115200

## WRITE PROTECTION FOR PROGRAMMED MACROS

You can use DIP switch 6 to prevent the programmed macros, images and fonts from being inadvertently overwritten.

Write protection	
DIP	Write protection for EEPROM
6	
ON	On No macro progr. possible
	Off
OFF	Macro progr. possible



## RS-232/RS-422 CONNECTION

The graphics kit is shipped with an RS-232 interface as standard. The pin assignment of the plug connector (J3) is as shown in the table on the left. The J3 has a 2.54mm grid. If the graphics kit is

RS-232 J3 connection			
Pin	Symb	In/Out	Function
1	VDD	-	+ 5V supply
2	DCD	-	Strap to DTR
3	DSR	-	Strap to DTR
4	TxD	Out	Transmit data
5	CTS	In	Clear to send
6	RxD	In	Receive data
7	RTS	Out	Request to send
8	DTR	-	See pin 2, pin 3
9	-	-	NC
10	GND	-	0V ground

ordered together with the EA OPT-RS4224 optional component, RS-422 drivers are fitted. In this case, the pin assignment is as shown in the table on the right.

The same serial data with 5V levels and TTL logic is available at the J5 eyelet strip. These levels are suitable for direct connection to a  $\mu$ C. However, if these signals are used, modules 202 and 75176 must be removed.

RS-422 J3 connection		
Pin	Symbol	Function
1	VDD	+ 5V supply
2	Data In-	Receive data
3	Data In+	Receive data
4	Data Out-	Transmit data
5	Data Out+	Transmit data
6	HS In-	Handshake
7	HS In+	Handshake
8	HS Out-	Handshake
9	HS Out+	Handshake
10	GND	0V ground

## SUPPLY VOLTAGE / EA OPT-9/35V

In the standard model, the supply voltage of +5V is fed in via screw-type terminal J1. In the case of the version for 9..35V (EA OPT-9/35V), the power is supplied via J2.

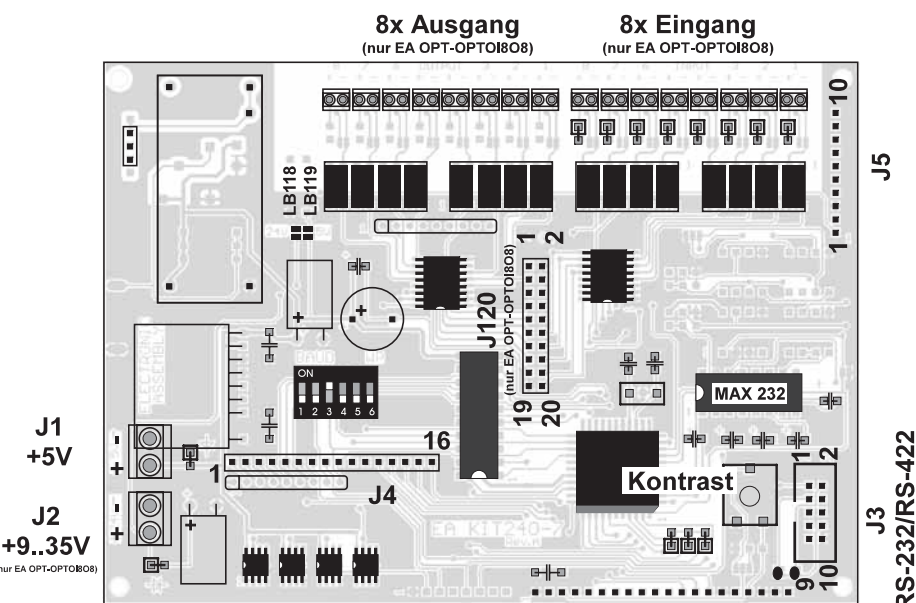

**Important:** It is imperative that the polarity is correct. Polarity reversal, even for a very short time, can cause the immediate destruction of the entire display.

J5 add-on			
Pin	Symbol	In/Out	Function
1	VU	-	9..35V supply
2	VDD	-	+ 5V supply
3	GND	-	0V, ground
4	TxD5	Out	Transmit data
5	RxD	In	Receive data
6	RTS	Out	Request to send
7	CTS	In	Clear to send
8	RESET	In	H: reset
9	SCL	Out	I2C bus, clock
10	SDA	In/Out	I2C bus, data



## ELECTRONIC ASSEMBLY

### EA OPT-OPTO8I8O INPUTS AND OUTPUTS

All EA KIT240 graphics kits are available optionally with 8 digital inputs and 8 outputs (EA OPT-OPTO8I8O). All the inputs and outputs are isolated from the rest of the electronic components as well as each other. The connection is made via 16 different screw-type terminals. At the same time the same outputs (non-floating) can be connected at the 20-pin plug-in connector (J120) via 5V CMOS level.

**Note:** The logic circuitry is designed for slow operations; in other words, more than 3 changes per second cannot be easily executed.

**Note:** The optocouplers invert the input logic (all inputs open: port macro 255). It is advisable here (in the power-on macro, for example) to use the "ESC Y I 1" command to evaluate the inputs inversely (all inputs open: port macro 0).

#### 8 outputs

Each line can be controlled individually using the "ESC Y W" command. A maximum current of 10mA can be switched per line.

#### 8 inputs

A voltage of >4V starts an internal port macro. However, the inputs can also be queried and evaluated directly via the serial interface ("ESC Y R"). When the 8 lines are combined, up to 256 port macros can thus be addressed. Each of these port macros can change the contents of the screen or switch an output, thus enabling a wide range of control functions. To create the port macros you need a PC and the EA DISK240 floppy disk. You will find a more detailed description on page 6. The automatic port query can be disabled by means of the "ESC Y A 0" command.

Pin	Symbol	Function	Pin	Symbol	Function
1	VDD	+5V supply	2	GND	0V, ground
3	OUT 1	Output 1	4	IN 1	Input 1
5	OUT 2	Output 2	6	IN 2	Input 2
7	OUT 3	Output 3	8	IN 3	Input 3
9	OUT 4	Output 4	10	IN 4	Input 4
11	OUT 5	Output 5	12	IN 5	Input 5
13	OUT 6	Output 6	14	IN 6	Input 6
15	OUT 7	Output 7	16	IN 7	Input 7
17	OUT 8	Output 8	18	IN 8	Input 8
19	GND	0V, ground	20	VDD	+5V supply

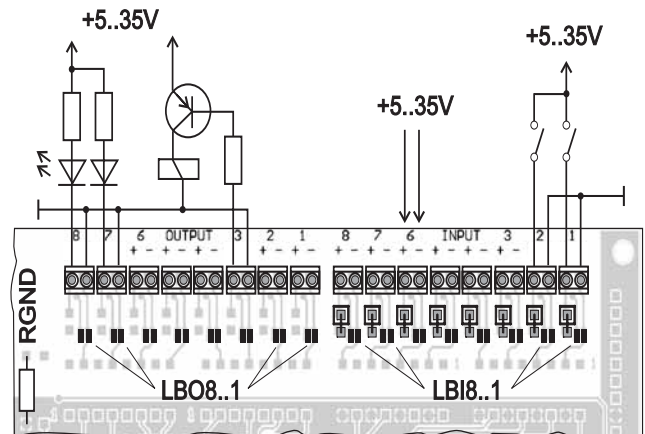

### APPLICATION EXAMPLES

Direct voltages of 5..35V can be applied at all 8 inputs. Voltages of over 4V are recognized as high level, while voltages of under 2V are low level. Voltages of between 2 and 4V are undefined. The polarity is insignificant.

The collector and emitter of a transistor is brought out at the screw-type terminals as the output. Each output can switch a maximum of 10mA. Ensure the polarity is correct, and note the transistor's load-dependent voltage drop of 0.6..5V.

**Note:** The negative pole of each screw-type terminal can be interconnected by closing the solder straps LBI1..8 and LBO1..8. These solder straps can also be connected to system ground GND (solder 0Ω strap R<sub>GND</sub>).

### DEFAULT SETTINGS

After power-on or a manual reset, the registers shown here are set to a specific value.

Please note that all the settings can be overwritten by creating a power-on macro (normal macro no. 0).

Register	Command	After power-on/reset
Text mode	ESC L	Set, black
Terminal font	ESC FT	Font 3, no zoom
Cursor	ESC QC	On
Flashing time	ESC QZ	0.6 secs
User-defined characters	ESC E	Undefined
Graphics mode	ESC V	Set
Graphics font	ESC F	Font 3, no zoom
Last xy	ESC W	(0;0)
Bar graph 1..16	ESC B	Undefined
Clipboard	ESC C	Empty
Select/deselect	ESC K	Selected
Outputs OUT1..8	ESC Y	High level/open

### MACROPROGRAMMING

Single or multiple command sequences can be grouped together in macros and stored in the EEPROM. You can then start them by using the *Run macro* commands. There are 3 different types of macros:

#### Touch macros (1..255)

These are started when you touch a touch field (in versions with a touch panel - TP) or when you operate an external key/matrix keyboard. Touch macro no. 0 is different: It is started when you release a key.

#### Port macros (0..255)

These are started when voltage is applied to IN 1..8 (only in versions with EA OPT-OPTO8I8O inputs and outputs).

#### Normal macros (1..255)

These are started by means of a command via the serial interface or from another macro. A series of macros occurring one after the other can be called cyclically (movie, hourglass, multi-page help text).

#### Power-on macro

Normal macro no. 0 is different: It is executed automatically after power-on. It allows you to switch off the cursor and define an opening screen, for example.

### STORING 256 IMAGES IN THE EEPROM

To reduce the transmission times of the serial interface or to save storage space in the processor system, up to 256 images can be stored in the internal EEPROM. They can be called using the "ESC U E" command via the serial interface or from within a touch/port/normal macro. All the images can be used in the Windows BMP format. They can be created and edit using widely available software such as Windows Paint or Photoshop.

### CREATING INDIVIDUAL MACROS

To create your own macros, you need the following:

- The EA DISK240\*) floppy disk, which contains a compiler, examples and fonts
- A PC with a COM1 or COM2 serial interface and approximately 500KB hard disk space
- A text editor such as WordPad or Norton Editor

To define a sequence of commands as a macro, all the commands are written to a file on the PC (e.g. DEMO.KMC). You specify which character sets are to be integrated and which command sequences are to be in which macros.

Once the macros are defined, you start the program C:>KITCOMP DEMO.KMC. This creates an EEPROM file called DEMO.EEP, which is then automatically stored in the display EEPROM with the baud rate entered. This only takes a few seconds, and you can then use your user-defined macros immediately. You will find a detailed description of how to program macros, together with a large number of examples, in the files DOKU.DOC (for WORD) and DOKU.TXT (DOS) on the EA DISK240\*) floppy disk.

```
;Macro demo
COM2: 115200                ; KIT is connected to COM2
                           ; Transmission at 115,200 baud
;-----
;Define constants
AUS = 0
EIN = 1
FONT4x6 = 1
FONT5x6 = 2
FONT6x8 = 3
FONT8x8 = 4
FONT8x16 = 5
;-----
;Include fonts
Font: FONT4x6, 32, 95 INTERN4x6
Font: FONT5x6, 32, 158 INTERN5x6
Font: FONT6x8, 32, 158 INTERN6x8
Font: FONT8x8, 32, 158 INTERN8x8
Font: FONT8x16, 32, 158 INTERN8x16
;-----
Macro: 0                    ; Power-on/reset macro
      #QC EIN                ; Cursor visible
      #FT FONT8x16           ; Set terminal font
      #UL 0, 20, <EA2.BMP>   ; ELECTRONIC ASSEMBLY logo
```

\*) Also on the Internet: <http://www.lcd-module.de/deu/disk/disk240.zip>

## ELECTRONIC ASSEMBLY

### INTEGRATED FONTS

5 character sets are integrated in each graphics unit as standard. Each character set can be used at its normal height or at up to 8 times this height. Independently of the height, the width can also be increased two to eight times.

Font 1: 4x6

+ Lower Upper	\$0 (0)	\$1 (1)	\$2 (2)	\$3 (3)	\$4 (4)	\$5 (5)	\$6 (6)	\$7 (7)	\$8 (8)	\$9 (9)	\$A (10)	\$B (11)	\$C (12)	\$D (13)	\$E (14)	\$F (15)
\$20 (dez: 32)		!	"	#	\$	%	&	'	(	)	*	+	,	-	.	/
\$30 (dez: 48)	0	1	2	3	4	5	6	7	8	9	:	;	<	=	>	?
\$40 (dez: 64)	@	A	B	C	D	E	F	G	H	I	J	K	L	M	N	O
\$50 (dez: 80)	P	Q	R	S	T	U	V	W	X	Y	Z	[	\	]	^	_

+ Lower Upper	\$0 (0)	\$1 (1)	\$2 (2)	\$3 (3)	\$4 (4)	\$5 (5)	\$6 (6)	\$7 (7)	\$8 (8)	\$9 (9)	\$A (10)	\$B (11)	\$C (12)	\$D (13)	\$E (14)	\$F (15)
\$20 (dez: 32)		!	"	#	\$	%	&	'	(	)	*	+	,	-	.	/
\$30 (dez: 48)	0	1	2	3	4	5	6	7	8	9	:	;	<	=	>	?
\$40 (dez: 64)	@	A	B	C	D	E	F	G	H	I	J	K	L	M	N	O
\$50 (dez: 80)	P	Q	R	S	T	U	V	W	X	Y	Z	[	\	]	^	_
\$60 (dez: 96)	^	a	b	c	d	e	f	g	h	i	j	k	l	m	n	o
\$70 (dez: 112)	p	q	r	s	t	u	v	w	x	y	z	{		}	~	À
\$80 (dez: 128)	Ç	ü	ë	ä	ö	ä	ç	è	é	ë	ï	î	ï	ä	ä	
\$90 (dez: 144)	É	æ	Æ	ö	ö	ö	ö	ö	ö	ö	ö	ö	ö	ö	ö	ö

Font 3: 6x8

justified or centered. 90° rotation (for vertical installation of the display) is also possible. Macro programming permits the inclusion of up to 11 additional fonts and the complete redesign of the individual characters. A font editor on the EA DISKFONT6963 floppy disk allows you to create and program in any font you like with a size of up to 16x16 pixels.

Font 5: 8x16

+ Lower Upper	\$0 (0)	\$1 (1)	\$2 (2)	\$3 (3)	\$4 (4)	\$5 (5)	\$6 (6)	\$7 (7)	\$8 (8)	\$9 (9)	\$A (10)	\$B (11)	\$C (12)	\$D (13)	\$E (14)	\$F (15)
\$20 (dez: 32)		!	"	#	\$	%	&	'	(	)	*	+	,	-	.	/
\$30 (dez: 48)	0	1	2	3	4	5	6	7	8	9	:	;	<	=	>	?
\$40 (dez: 64)	@	A	B	C	D	E	F	G	H	I	J	K	L	M	N	O
\$50 (dez: 80)	P	Q	R	S	T	U	V	W	X	Y	Z	[	\	]	^	_
\$60 (dez: 96)	^	a	b	c	d	e	f	g	h	i	j	k	l	m	n	o
\$70 (dez: 112)	p	q	r	s	t	u	v	w	x	y	z	{		}	~	À
\$80 (dez: 128)	Ç	ü	ë	ä	ö	ä	ç	è	é	ë	ï	î	ï	ä	ä	
\$90 (dez: 144)	É	æ	Æ	ö	ö	ö	ö	ö	ö	ö	ö	ö	ö	ö	ö	ö

### TIP: FONT EFFECTS

With large fonts, you can use the command ESC L TEXT mode (link, pattern) to produce interesting effects through overlaying (writing and offsetting a word several times).

TEST

Original font 8x16 with ZOOM 3 at position 0,0 with black pattern

TEST

"Outline font" produced by overlaying (EXOR) at pos. 1,1

TEST

Overlaying (EXOR) of the "outline font" at pos. 2,2. results in an "outline font with fill"

TEST

Overlaying (OR) with 50% gray pattern of the "outline font" at pos. 0,0. results in a "font with pattern fill"

## ALL COMMANDS AT A GLANCE

Command table for the EA KIT240										
Command	Codes					Note				
<b>Commands for terminal operation</b>										
Form feed FF (dec:12)	^L					Deletes the screen and sets the cursor at position (1,1)				
Carriage return CR(13)	^M					Positions the cursor on the left at the beginning of the line				
Line feed LF (dec:10)	^J					Positions the cursor in the line below the current one. If the cursor is in the last line, positions it in the 1st line				
Cursor on/off	ESC	Q	C	n1		n1=0: cursor is not visible; n1=1: cursor flashes (inverse 6/10s)				
Position cursor	ESC	O	n1	n2		n1=column; n2=line; upper left origin is (1,1)				
Set terminal font	ESC	F	T	n1		n1=1: sets font no. n1 (1..16) for terminal operation				
<b>Text output commands</b>										
Text mode	ESC	L	n1	pat		Mode n1: 1=set; 2=delete; 3=inverse 4=replace; 5=inverse replace; pat: pattern no. 0..7				
Set font	ESC	F	n1	n2	n3	Sets font with the number n1 (1..16); n2=X- n3=Y-zoom factor (1x..8x)				
Output string horizontally	ESC	Z	L Z R	x1	y1	Text ... NUL	Outputs a string (...) at x1,y1. 'NUL' (\$00)=end of string; lines are separated by the character ' ' (\$7C, dec:124); 'L':= left justified at x1; 'Z':= centered at x1; 'R':= right justified at x1; y1 is always the upper edge of the string			
Output string rotated by 90° (vertically)	ESC	Z	O M U	x1	y1	Text ... NUL	Outputs a string (...) rotated by 90° at x1,y1; 'NUL' (\$00)=end; lines are separated by the character ' ' (\$7C, dec: 124); 'O':= top justified at y1; 'M':= vertically centered at y1; 'U':= bottom justified at y1; x1 is always the right edge of the string			
Define character	ESC	E	n1	data ...			n1=character no.; data=number of bytes depending on current font			
<b>Drawing commands</b>										
Graphics mode	ESC	V	n1				Sets the drawing mode for the commands 'Set point', 'Draw straight line', 'Rectangle', 'Rounded rectangle' and 'Fill area with pattern' n1: 1=set; 2=delete; 3=inverse; 4=replace; 5=inverse replace			
Set point	ESC	P	x1	y1			Sets a pixel at position x1, y1			
Draw straight line	ESC	G	x1	y1	x2	y2	Draws a straight line from x1,y1 to x2,y2			
Continue straight line	ESC	W	x1	y1			Draws a straight line from the last end point to x1, y1			
<b>Rectangle commands</b>										
Draw rectangle	ESC	R	R	x1	y1	x2	y2	Draws a rectangle (frame) from x1,y1 to x2,y2		
Draw rounded rectangle			N	x1	y1	x2	y2	Draws a rectangle with rounded corners from x1,y1 to x2,y2		
Delete area			L	x1	y1	x2	y2	Deletes an area from x1,y1 to x2,y2 (all pixels off)		
Invert area			I	x1	y1	x2	y2	Inverts an area from x1,y1 to x2,y2 (inverts all pixels)		
Fill area			S	x1	y1	x2	y2	Fills an area from x1,y1 to x2,y2 (all pixels on)		
Fill area with pattern			M	x1	y1	x2	y2	pat	Fills an area from x1,y1 to x2,y2 with the pattern pat (0..7)	
Draw box			O	x1	y1	x2	y2	pat	Draws a rectangle with the fill pattern pat (0..7); (always replace)	
Draw rounded box			J	x1	y1	x2	y2	pat	Draws a rectangle with the fill pattern mst (0..7); (always replace)	
<b>Bitmap image commands</b>										
Image from EEPROM	ESC	U	E	x1	y1	no		Loads an internal image with the number (0..255) from the EEPROM to x1,y1		
Load image			L	x1	y1	data ...		Loads an image to x1,y1; see image structure for the data of the image		
Send hard copy			H	x1	y1	x2	y2	Requests an image. Sends the width and height in pixels followed by the actual image data via RS232		
<b>Display commands (which apply to the whole display)</b>										
Delete display	ESC	D	L					Deletes the contents of the display (all pixels off)		
Invert display			I					Inverts the contents of the display (inverts all pixels)		
Fill display			S					Fills the contents of the display (all pixels on)		
Switch display off			A					Makes the contents of the display invisible, but they remain there and further commands are possible		
Switch display on			E					Makes the contents of the display visible again		
Clipboard display			C					Displays the contents of the clipboard. The display contents are no longer visible		
Normal display			N					Displays the current image (normal mode). All outputs are visible again		
Reset display			R					Resets and re-initializes the display controller		
<b>Macro commands</b>										
Execute macro	ESC	M	N	n1					Calls the (normal) macro with the number n1 (max. 7 levels)	
Execute touch macro			T	n1					Calls the touch macro with the number n1 (max. 7 levels)	
Execute port macro			P	n1					Calls the port macro with the number n1 (max. 7 levels)	
Macros autom. cyclical			A	n1	n2	n3			Processes macros n1..n2 automatically cyclically; n3=pause in 1/10s	
Macros autom. ping-pong			J	n1	n2	n3			Processes macros n1..n2..n1 automatically (ping-pong); n3=pause in 1/10s	



Bar graph commands													
Define bar graph	ESC	B	R L O U	no	x1	y1	x2	y2	sv	ev	pat	Defines a bar graph to the left (L), right (R), top (O) or bottom (U) with the number no (1..16). x1,y1,x2,y2 define the rectangle enclosing the bar graph. sv,ev are the values for 0% and 100%. pat=pattern (0..7)	
Draw bar graph				no	value							Sets the bar graph with the number no (1..16) to the new user 'value'	
Clipboard commands (clipboard for image areas)													
Save display contents	ESC	C	B									Copies the entire contents of the display to the clipboard as an image area	
Save image			S	x1	y1	x2	y2					Copies the image area from x1, y1 to x2, y2 to the clipboard	
Restore display			R										Copies the image area on the clipboard back to the display
Copy area			K	x1	y1								Copies the image area on the clipboard to position x1, y1 in the display
Keyboard/touch panel commands													
Define touch key with horizontal label	ESC	T	H	f1	f2	Ret code	Form	Text ...	NUL			Groups touch fields f1 to f2 (diametrically opposite corner fields) together to form a touch key with the return value 'Ret. code' (=1..255) (Ret. code=0 means the touch key is inactive). "Form": Draws touch key (=0 nothing; =1 delete; =2 with frame) "Text": Positions a string on the touch key (centered) using the current font; lines are separated by the character ' ' (\$7C, dec: 124); NUL character (\$00) = end of string	
Define touch key with vertical label (rotated by 90°)			V										
(P)reset touch keys			P										Activates all touch keys in ascending order (fields with code 1..60)
			R										Deactivates all touch keys (all fields with code 0)
Touch key response			I	n1									n1=0: Touch key is not inverted when touched n1=1: Touch key is automatically inverted when touched
			S	n1									n1=0: No tone sounds when (touch) key is touched n1=1: Tone sounds briefly when (touch) key is touched
Invert touch key			M	n1									The touch key assigned the return code n1 is inverted manually
Query key manually			W										Sends the currently depressed (touch) key at the RS-232/RS-422 interface
Key query on/off	A	n1									The keyboard query is n1=0:deactivated; n1=1:activated, keystrokes are sent automatically; n1=2:activated, keystrokes are not sent (query with ESC T W)		
Menu/pop-up commands													
Define menu with horizontal items	ESC	N	H	x1	y1	no	Text ...	NUL				Draws a menu from the corner x1,y1 (horizontal menu = upper left corner; vertical menu = upper right corner) using the current font. no:= currently inverted item (e.g.: 1 = 1st item) Text:= string with the menu items. The items are separated by the character ' ' (\$7C,dec:124), e.g. "Item1 Item2 Item3" The background of the menu is automatically saved to the clipboard. If a menu is already defined, it is automatically canceled and removed	
Define menu with vertical items (rotated by 90°)			V										
Invert menu box			I										Inverts the entire menu box. Useful for negative display
Next item			N										Inverts the next item or remains at the end
Previous item			P										Inverts the previous item or remains at the beginning
Menu end/send			S										Removes the menu from the display and replaces it with the clipboard contents. The current item is sent as a number (1..n) (0=no menu displayed)
Menu end/macro			M	no									Removes the menu from the display and replaces it with the contents of the clipboard. Macro 'no' is called for item 1; macro no+1 for item 2, and so on
Menu end/cancel			A										Removes the menu from the display and replaces it with the contents of the clipboard
Control/definition commands													
Automatic flashing area (cursor function)	ESC	Q	D	x1	y1	x2	y2					Defines a flashing area from x1,y1 to x2,y2; activates the flashing function	
			Z	n1									Sets the flashing time n1= 1..15 in 1/10s; 0=deactivates the flashing function
			M	l	pat								Inverse mode (flashing area is inverted); activates the flashing function Clipboard mode pat=pattern (0..7) of the block cursor; activates flashing
			C	n1								Automatically flashing area as cursor for terminal operation n1=0: deactivates flashing function; n1=1: activates flashing function (inverse, 6/10s)	
Select/deselect	ESC	K	S	add								Activates the kit with the address n1 (n1=255: all)	
			D	add									Deactivates the kit with the address n1 (n1=255: all)
			A	add									Assigns a new address (add) (in the power-on macro, for example)
Wait (pause)	ESC	X	n1								Wait n1 tenths of a second before the next command is executed		
Buzzer on/off	ESC	J	n1									n1=0:tone off; n1=1:tone on; n1=2..255:for n1 1/10s long on	
Send bytes	ESC	S	num					data ...				Sends num (1..255; 0=256) bytes at the RS-232/RS-422 interface; data ... = num bytes (e.g. control of an external serial printer)	
Read I2C bus	ESC	I	R	add	num							Requests num (1..255; 0=256) bytes from the module on the I2C bus with the device address add and sends them via the RS-232/RS-422	
Write I2C bus	ESC	I	W	add	num			data ...				Sends num (1..31) bytes on the I2C bus for the module with the device address add. data ... = num bytes	
Port commands													
Write output port	ESC	Y	W	n1	n2							n1=0: Sets all 8 output ports in accordance with n2 (=8-bit binary value) n1=1..8: Resets (n2=0), sets (n2=1) or inverts (n2=2) output port n1	
Read input port			R	n1									n1=0: Reads in all 8 input ports as 8-bit binary value n1=1..8: Reads in input port <n1> (1=high level=5V, 0=low level=0V)
Port scan on/off			A	n1									Deactivates (n1=0) or activates (n1=1) automatic scanning of the input port
Input port inverse			I	n1									

### PARAMETERS

The graphics kit can be programmed by means of various integrated commands. Each command begins with ESC followed by one or two command letters and then parameters. All the commands and their parameters, such as coordinates and other transfer values, are always expected as bytes. No separating characters, such as spaces or commas, must be used between them. The commands require **no final byte** such as a carriage return (except for the string \$00).

**A..Z, L/R/O/U** ..... All commands are transferred as ASCII characters.  
Example: G= 71 (dec.) = \$47 initiates the straight-line command.

**x1, x2, y1, y2** ..... Coordinates are transferred with 1 byte.  
Example: x1= 10 (dec.) = \$0A

**ESC** ..... 1 byte: 27(dec.) = \$1B

**n1,n2,nr,aw,ew,wert,mst,ret, frm,daten** ..... Numerical values are transferred with 1 byte.  
Example: n1=15(dec.) = \$0F

### PROGRAMMINGEXAMPLE

The following table shows an example in which the string "Test" is output left justified at coordinate 7,3.

Example	Codes to be output									
	ESC	Z	L	BEL	ETX	T	e	s	t	NUL
In ASCII										
In hex	\$1B	\$5A	\$4C	\$07	\$03	\$54	\$65	\$73	\$74	\$00
In decimal	27	90	76	7	3	84	101	115	116	0
For Turbo Pascal	write(aux, chr(27), 'Z', 'L', chr(7), chr(3), 'Test', chr(0));									
For C	fprintf(stdaux, "\x1BZL%c%c%s\x00", 7, 3, "Test");									
For Q Basic	OPEN "COM1:9600,N,8,1,BIN" FOR RANDOM AS #1 PRINT #1,CHR\$(27)+"ZL"+CHR\$(7)+CHR\$(3)+"Test"+CHR\$(0)									

### PATTERN

A pattern type (mst = 0..7) can be set as a parameter with some commands. In this way, rectangular areas, bar graphs and even texts can be linked to different patterns and displayed.

The following fill patterns are available:

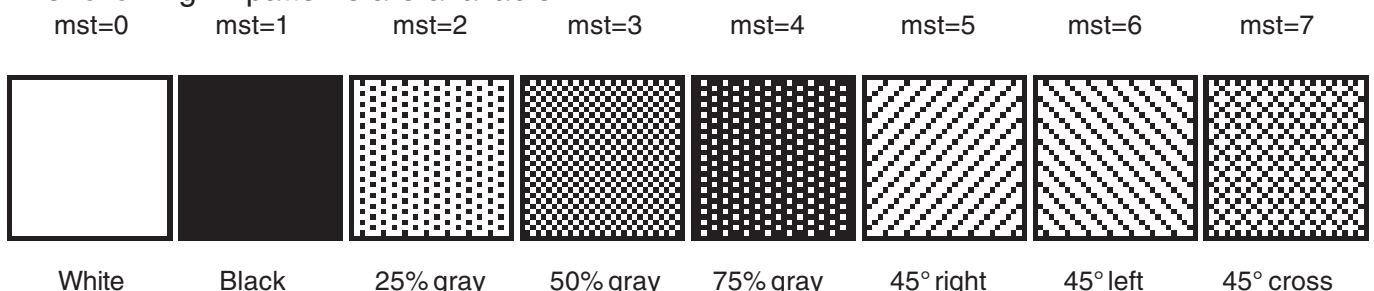

## ELECTRONIC ASSEMBLY

## DESCRIPTIONS OF THE VARIOUS GRAPHICS FUNCTIONS

On the following pages you will find detailed descriptions of all of the functions in alphabetical order. In each case, an enlarged section of the image, 50x32 pixels in size, is shown as a hard copy example, indicating the contents of the display after the command is executed. The bytes to be transferred are shown as hex values in the examples.

**ESC B L/R/O/U no x1 y1 x2 y2 sv ev pat Define bar graph**

Up to 16 bar graphs (**no**=1..16) can be defined. These can extend to the left (**L**), right (**R**), up (**O**) or down (**U**). At its full extent, the bar graph occupies an area from **x1,y1** to **x2,y2**. It is scaled with the start value (no extension) **sv** (=0..254) and the end value (full extension) **ev** (=0..254). The bar graph is always drawn in inverse mode with the pattern (**pat**): The background is thus always retained. (Note: When this command is executed, it defines the bar graph but does not display it).

Example: \$1B \$42 \$4F \$01 \$04 \$02 \$09 \$1E \$04 \$14 \$01

Bar graph no. 1, which extends upwards, is defined. When it is fully extended, it takes up an area from 4,2 to 9,30. The start and end values correspond to a 4..20 mA display. (The diagram shows the bar graph fully extended, as represented with \$42 \$01 \$14.)

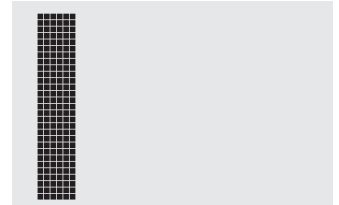
**ESC B no value**

The bar graph with the number **n1** (1..16) is set to the new value (**sv** <= **value** <= **ev**). If **value** > **ev**, the end value (**ev**) is displayed. The bar graph must be defined first (see above).

Example: \$1B \$42 \$01 \$0A

Bar graph no. 1 defined in the above example is set to a value of 10.

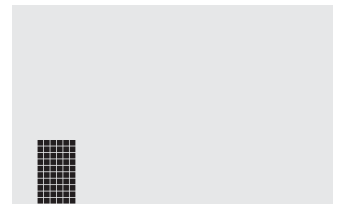
**Draw bar graph****ESC C B Save contents of display to clipboard**

Copies the entire contents of the display to the clipboard.

Example: \$1B \$43 \$42

Saves the entire contents of the display to the clipboard so that the screen can subsequently be restored. The contents of the display do not change.

**ESC C S x1 y1 x2 y2 Save area to clipboard**

Copies an area from the upper left corner (**x1,y1**) to the lower right corner (**x2,y2**) to the clipboard.

Example: \$1B \$43 \$53 \$00 \$00 \$17 \$1B

Saves the area from 0,0 to 23,27 so that the screen can subsequently be restored. The contents of the display do not change.

**ESC C R Restore area**

Copies the the area last saved from the clipboard back to the display. Destination: the original coordinates.

Example: \$1B \$43 \$52

Restores the area last saved.

**ESC C K x1 y1 Copy area from clipboard**

Copies the area last saved on the clipboard to a new position (**x1,y1**) on the display.

Example: \$1B \$43 \$4B \$0A \$20

Copies the area last saved to the point 10,32.

## ESC D L/I/S

## Change contents of display

The entire contents of the display are deleted (**L** - white), inverted (**I**) or filled (**S** - black).

Example: \$1B \$44 \$49

Inverts the entire contents of the display.

## ESC D A/E

## Switch display on/off

Switches the contents of the display off (**A** - not visible) or on (**E** - visible). Outputs are still possible when it is switched off.

Example: \$1B \$44 \$41

The contents of the display are no longer visible after this command.

## ESC D N/C

## Display normal/clipboard contents

The normal contents (**N**) or the clipboard contents (**C**) appear on the display. Concealed drawing is possible with this command. Example: The current contents of the display are saved to the clipboard with **ESC C B**, and the contents of the clipboard are then displayed with **ESC D C**. All subsequent outputs to the display will be invisible until the command **ESC D N** is entered, at which point the current contents will become visible again.

Example: \$1B \$44 \$49

The display now shows the contents of the clipboard (only complete images are recognizable).

## ESC E n1 data

## Define character

You can define up to 21 characters yourself (depending on the font size). These characters then have the ASCII codes 1 to max. 21 and remain in an invisible screen RAM 128 bytes in size until the supply voltage is switched off. In the case of a 4x6 font, up to 21 characters can be defined, whereas only 8 characters can be defined for an 8x16 font. Please note that if you want to define several characters in different fonts, you must bear in mind that a character with code 1 of the 8x16 font, for example, requires the same amount of RAM as the characters with the codes 1 to 3 in the 4x6 font (see the adjacent table).

Example 1:

\$1B \$45 \$01

\$20 \$70 \$A8 \$20 \$20 \$20 \$20 \$00

Defines an arrow pointing upward for ASCII no. 1 using the 6x8 character set.

Example 2:

\$1B \$45 \$02

\$10 \$10 \$10 \$10 \$10 \$10 \$10 \$10 \$10 \$10 \$92 \$54 \$38 \$10 \$00 \$00

Defines an arrow pointing downward for ASCII no. 2 using the 8x16 character set.

		BIT NO.							
		7	6	5	4	3	2	1	0
Byte 1									
Byte 2									
Byte 3									
Byte 4									
Byte 5									
Byte 6									
Byte 7									
Byte 8									

		BIT NO.							
		7	6	5	4	3	2	1	0
Byte 1									
Byte 2									
Byte 3									
Byte 4									
Byte 5									
Byte 6									
Byte 7									
Byte 8									
Byte 9									
Byte 10									
Byte 11									
Byte 12									
Byte 13									
Byte 14									
Byte 15									
Byte 16									

		User-definable characters (code)			
		4x6	6x8	8x1	16x16
		5x6	8x8	8x8	16
1	1				
2	2		1		
3	3			1	
4	4		2		
5	5				
6	6		3		
7	7			2	
8	8		4		
9	9				
10	10		5		
11	11			3	
12	12		6		
13	13				
14	14		7		
15	15			4	
16	16		8		
17	17				
18	18		9		
19	19				
20	20		10		
21	21				

## ESC F n1 n2 n3

## Set font

Sets the font with the number **n1** (1=4x6 uppercase letters only; 2=6x8; 3=8x16). In addition, an enlargement factor (1..8 times) is set for the width (**n2**) and height (**n3**) separately.

Example: \$1B \$46 \$02 \$03 \$04

The 6x8 with 3 times the width and 4 times the height is set with immediate effect. In the adjacent figure, the character 'E' is shown in the 6x8 font and with various enlargement factors.

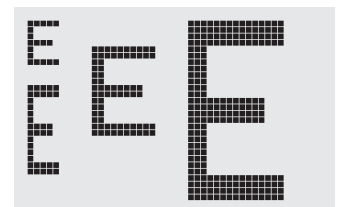

## ESC F T n1

## Set terminal font

Sets the font with the number **n1** for terminal operation. The font for the terminal is always used without zoom and in REPLACE mode.

Example: \$1B \$46 \$54 \$03

The 6x8 font is set as the terminal font with immediate effect.



## ELECTRONIC ASSEMBLY

### ESC G x1 y1 x2 y2

A straight line is drawn from **x1,y1** to **x2,y2** taking into account the graphics mode set 'V' (set/delete/inverse).

Example: \$1B \$47 \$03 \$14 \$28 \$06

A straight line is drawn from 3,20 to 50,6.

### Draw straight line

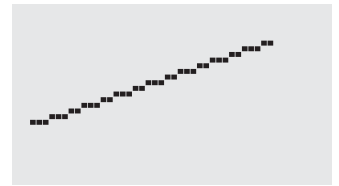

### ESC H x1 y1 x2 y2

### Create hard copy of display contents

Requests the area from the upper left corner (**x1,y1**) to the lower right corner (**x2,y2**). The graphics chip then immediately sends the width and height of the image section followed by the image data. See the upload image command ('U') for the structure of the image data.

Example: \$1B \$48 \$00 \$00 \$1F \$0F

The upper left part of the screen (32 x 16 pixels) is sent via RS-232.

### ESC J n1

### Switch tone on/off manually

Switches the tone off (**n1=0**), on for an undefined period (**n1=1**) or on for n1/10 seconds (**n1=2..255**). (This only applies to versions with EA KIT240-7CTP and EA KIT240-7LEDTP touch panels.)

Example: \$1B \$4A \$0A

The tone sounds for 1 second after this command.

### ESC K A add

### Assign address

Assigns an address to the KIT240 (**add=0..254**). The best place for this command is in the power-on macro.

Example: \$1B \$4B \$41 \$01

The KIT240 is assigned the address \$01 with immediate effect.

### ESC K S/Dadd

### (De)select KIT240

Selects (**S**) or deselects (**D**) the KIT240 with the address **add** (0..254); the address 255=\$FF is a master address for all KIT240 units.

Example: \$1B \$4B \$44 \$01

All commands for the KIT240 with the address \$01 are ignored with immediate effect.

### ESC L n1 pat

### Set text mode

Sets the link mode (**n1**) and pattern (**pat**) for the string output text function (**ESC Z**).

Example: \$1B \$4C \$03 \$03

Sets the link mode for all subsequent text functions to gray characters (pattern 3 = 50% gray) inverted with the background.

Link mode n1:

- 1 = set: black pixels irrespective of the previous value (OR)
- 2 = delete: white pixels irrespective of the previous value
- 3 = inverse: changes black pixels to white pixels and vice versa (EXOR)
- 4 = replace: deletes the background and sets black pixels
- 5 = inverse replace: fills the background and sets white pixels

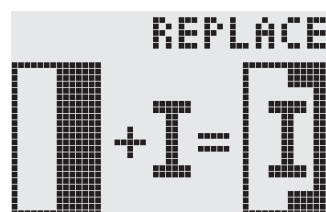
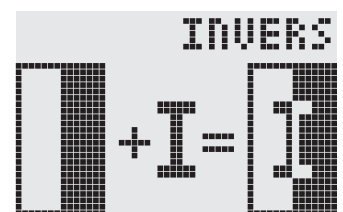
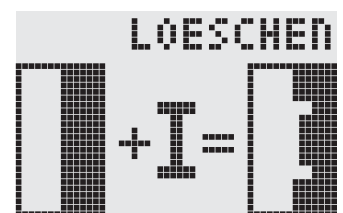
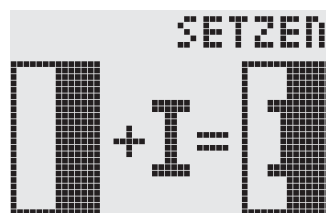

### ESC M N/T/P n1

### Call macro

Calls the normal macro (N), touch macro (T) or port macro (P) with the number n1 (0..255).

Example: \$1B \$4D \$4E \$0F

The (normal) macro with the number 15 is executed.

### ESC M A/Jn1 n2 n3

### Execute macros automatically

Calls the normal macros with the numbers n1 to n2 automatically every n3/10 seconds. A=cyclical call (e.g. 1,2,3,4,1,2,3,4, etc.); J=ping-pong call (e.g. 1,2,3,4,3,2,1,2,3,4, etc.).

Automatic execution is terminated:

- When a character is received from the RS-232 interface
- When a touch automatically executes a touch macro
- When an input change executes a port macro

Example: \$1B \$4D \$41 \$01 \$03 \$05

The macros with the numbers 1, 2 and 3 are executed automatically with a break of 1/2 second.

### ESC N H/Vx1 y1 no Text... NUL

### Display menu

Defines and displays a menu with the current font. The background of the menu box is automatically saved on the clipboard (**the previous contents of the clipboard are lost**): H=horizontal menu at x1,y1 (upper left corner) or V=vertical menu (rotated 90°) at x1,y1 (upper right corner). n1=currenty inverted item; Text...=string containing the items. The individual items are separated by the character '|' (=\$7C). The string must be terminated with NUL= \$00.

Example 1 - Horizontal menu:

\$1B \$4E \$48 \$02 \$02 \$01

\$54 \$65 \$73 \$74 \$7C \$53 \$74 \$6F \$70 \$7C \$45 \$6E \$64 \$00

Defines a horizontal menu containing the items "Test", "Stop" and "End" at position 2,2. The 1st item is inverted.

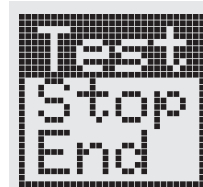

Example 2 - Vertical menu:

\$1B \$4E \$56 \$28 \$01 \$01

\$54 \$65 \$73 \$74 \$7C \$53 \$74 \$6F \$70 \$7C \$45 \$6E \$64 \$00

Defines a vertical menu containing the items "Test", "Stop" and "End" at position 40,1. The 1st item is inverted.

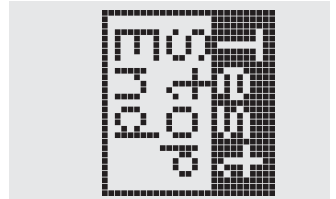

### ESC N N/P

### Next/previous menu item

Inverts the next (N) or previous (P) menu item. If the last/first item is already inverted, the command is ignored.

Example: \$1B \$4E \$4E

The next menu item is inverted.

### ESC N I

### Invert menu box

Inverts the entire menu box.

Example: \$1B \$4E \$49

### ESC N S

### Terminate and send menu

Removes the menu from the display and replaces it with the background from the clipboard. The currently selected item is sent as a number (1..max. item) via the RS 232 interface.

Example: \$1B \$4E \$53

### ESC N M n1

### Terminate menu and call macro

Removes the menu from the display and replaces it with the background from the clipboard. If item 1 is selected, the (normal) macro with the number n1 is called, for item 2 the macro n1+1 etc.

Example: \$1B \$4E \$4D \$0A

### ESC N A

### Cancel menu

Removes the menu from the display and replaces it with the background from the clipboard.

Example: \$1B \$4E \$41

## ELECTRONIC ASSEMBLY

**ESC O n1 n2****Position cursor**

Sets the cursor to column **n1** and row **n2** for terminal operation. The origin in the upper left corner is 1,1.

Example: \$1B \$4F \$03 \$05

Sets the cursor to the 3rd column in row 5.

**ESC P x1 y1****Set dot**

Sets a pixel at **x1,y1** taking into account the graphics set mode 'ESC V' (set/delete/invert).

Example: \$50 \$11 \$0D

Sets the pixel at 17,13.

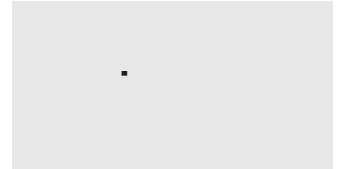
**ESC Q C n1****Cursor on/off**

**n1=1:** Switches the cursor on; it flashes at the current position on the terminal.

**n1=0:** Switches the cursor off.

Example: \$1B \$51 \$43 \$01

Switches the cursor off.

**ESC Q D x1 y1 x2 y2****Define flashing area**

Defines the area from the upper left corner (**x1,y1**) to the lower right corner (**x2,y2**) as an automatically flashing area. The flashing function is started at the same time. This deactivates the terminal cursor.

Example: \$1B \$51 \$44 \$00 \$0F \$07 \$10

Defines the flashing area from 0,15 to 7,16.

**ESC Q Z n1****Set flashing time**

Sets the flashing time to **n1** (=1..15) tenths of a second. When **n1= 0**, the flashing function is deactivated and the original screen restored.

Example: \$1B \$51 \$5A \$03

Sets the flashing time to 0.3 seconds.

**ESC Q M I****Inverse flashing mode**

Automatically inverts the defined flashing area cyclically with the set flashing time. The flashing function is started at the same time.

Example: \$1B \$51 \$49

Sets the inverse flashing mode.

**ESC Q M pat****Block cursor flashing mode**

Saves the defined flashing area on the clipboard (**the previous contents of the clipboard are lost**). There is a cyclical changeover between the original area and the pattern **pat** (=0..7) on the basis of the set flashing time. In this way, for example, a block cursor can be simulated (**pat=1** black) or a flashing word displayed (**pat=0** white). The flashing function is started at the same time.

Example: \$1B \$51 \$43 \$00

The block cursor flashing mode is set with the pattern white. As a result, the set area flashes on a white background.

**ESC R R x1 y1 x2 y2****Draw rectangle**

Draws a rectangle from the upper left corner (**x1,y1**) to the lower right corner (**x2,y2**) taking into account the set graphics mode 'V' (set/delete/inverse). The contents of the rectangle are not changed. See 'ESC R O' (Draw box).

Example: \$1B \$52 \$52 \$15 \$08 \$30 \$25

Draws a rectangle from 21,8 to 48,37.

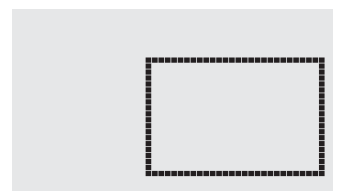

### ESC R N x1 y1 x2 y2

Draws a rectangle with rounded corners from the upper left corner (**x1,y1**) to the lower right corner (**x2,y2**) taking into account the set graphics mode 'V' (set/delete/inverse). The contents of the rounded rectangle are not changed. See 'ESC R J' (Draw rounded box).

Example: \$1B \$52 \$4E \$06 \$02 \$26 \$13  
Draws a rounded rectangle from 6,2 to 38,19.

### ESC R L x1 y1 x2 y2

Deletes the area from the upper left corner (**x1,y1**) to the lower right corner (**x2,y2**).

Example: \$1B \$44 \$53 \$1B \$52 \$4C \$06 \$04 \$28 \$19  
The display is filled with **ESC D S** and then deleted from 6,4 to 40,25.

### ESC R I x1 y1 x2 y2

Inverts the area from the upper left corner (**x1,y1**) to the lower right corner (**x2,y2**) (black pixels turn white and vice versa).

Example: \$1B \$52 \$49 \$00 \$00 \$17 \$1B  
Inverts the area from 0,0 to 23,27 with the display contents from the "Set font" example.

### ESC R S x1 y1 x2 y2

Fills the area from the upper left corner (**x1,y1**) to the lower right corner (**x2,y2**) (sets the pixels to black).

Example: \$1B \$52 \$53 \$09 \$05 \$16 \$16  
Sets the area from 9,5 to 22,22 black.

### ESC R M x1 y1 x2 y2 pat

Fills a rectangular area from the upper left corner (**x1,y1**) to the lower right corner (**x2,y2**) with the pattern **pat** taking into account the set graphics mode "ESC V" (set/delete/invert/replace/inverse replace).

Example: \$1B \$52 \$4D \$05 \$01 \$2D \$1A \$07  
Fills the area with the pattern 7=45°cross from 5,1 to 45,26.

### ESC R O x1 y1 x2 y2 pat

Draws a rectangle from the upper left corner (**x1,y1**) to the lower right corner (**x2,y2**) with the pattern **pat**. The background of the box is deleted. See 'ESC R R' (Draw rectangle).

Example: \$1B \$52 \$4F \$02 \$05 \$12 \$1E \$02  
Draws a box from 2,5 to 18,30 with the pattern 2=25%gray.

### ESC R J x1 y1 x2 y2 pat

Draws a rectangle with rounded corners from the upper left corner (**x1,y1**) to the lower right corner (**x2,y2**) with the pattern **pat**. The background is deleted. See 'ESC R N' (Draw rounded rectangle).

Example: \$1B \$52 \$4A \$07 \$03 \$23 \$16 \$03  
Draws a rounded box from 7,3 to 35,22 with the pattern 3=50%gray.

### ESC S num data...

Outputs the next **num** (1..255, 0=256) bytes at the serial interface.

Example: \$1B \$53 \$04 \$54 \$45 \$53 \$54  
Transmits the word 'TEST' via the RS-232C interface.

### Draw rounded rectangle

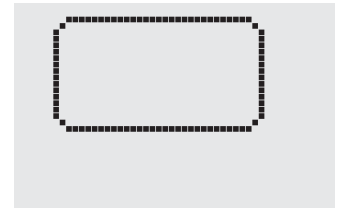

### Delete area



### Invert area

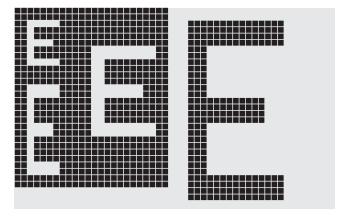

### Fill area

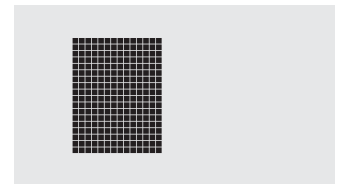

### Fill area with pattern

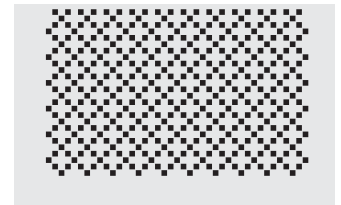

### Draw box

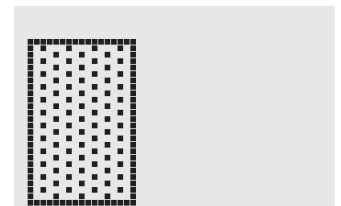

### Draw rounded box

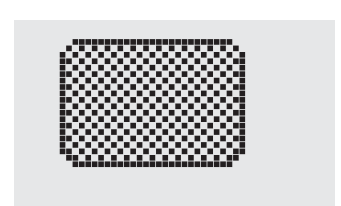

### Send bytes via RS-232



## ELECTRONIC ASSEMBLY

**ESC T H/Vf1 f2 ret frm text... NUL****Define touch key**

Defines a touch key and labels it with the current font. **H**=horizontal or **V**=vertical labeling (rotated 90°). Several touch fields can be grouped together to form a single touch key (**f1**=upper left touch field; **f2**=lower right touch field of the new touch key). This touch key is assigned a return code with **ret** (1..255). When the touch key is touched, the touch macro with the number **ret** is called or, if no touch macro is defined, this return code is sent via the RS232. You use **frm** to define the format of the touch key (frm=0: don't draw anything; frm=1: delete touch key; frm=2: delete touch key and draw with frame). **text...**=string with the label (which is always centered on the touch key). The label can also have more than one line; in this case, the lines are separated by the character '|' (=7C). The string must be concluded with **NUL**= \$00. See example on page 3.

Example 1: Horizontal touch key:

```
$1B $54 $48 $01 $01 $41 $02 $54 $45 $53 $54 $00
```

Defines a horizontal touch key (field no. 1 only) with the return code 65='A'. The touch key is drawn with a frame and labeled with the word 'TEST'.

Example 2: Vertical touch key:

```
$1B $54 $56 $02 $02 $42 $02 $54 $45 $53 $54 $00
```

Defines a vertical touch key (touch field no. 2 only) with the return code 66='B'. The touch key is drawn with a frame and labeled with the word 'TEST'.

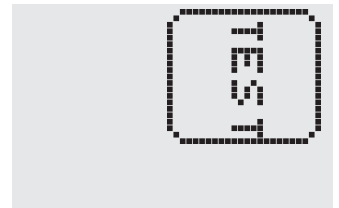
**ESC T P/R****Preset/reset touch fields**

Assigns **P** (=ascending return code: 1..60) or **R** (=reset all touch fields) to all 60 touch fields. In the latter case all touch fields receive the return code 0 (i.e. they are deactivated).

Example: \$1B \$54 \$52

All touch fields are deactivated by this command and no longer recognized.

**ESC T I/S n1****Touch key response**

These commands set the automatic response of the touch panel to touching. Both responses can be activated simultaneously.

**I**=automatic inversion when the touch key is touched (**n1**=0: off or **n1**=1: on)

**S**=automatic signal tone when the touch key is touched (**n1**=0: off or **n1**=1: on)

Example: \$1B \$54 \$49 \$01

After this command the tone sounds when a touch key is touched.

**ESC T M ret****Invert touch key manually**

This command manually inverts the touch key with the return code **ret**.

Example: \$1B \$54 \$4D \$41

Inverts the touch key from the above example with the return code 65='A'.

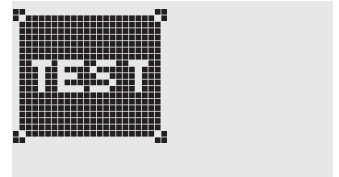
**ESC T A n1****(Touch) key query on/off**

This command sets the (touch) key query:

**n1**=0: Switches the key query off - no touch macros or manual key query possible.

**n1**=1: Activates the key query - keystrokes trigger touch macros or are sent via RS232.

**n1**=2: Activates the key query - keystrokes trigger touch macros; must be queried manually.

Example: \$1B \$54 \$41 \$02

Activates the (touch) key query. The keystrokes are not sent automatically via RS232; they have to be requested manually by means of the command **ESC T W**.

**ESC T W****Query touch key manually**

Sends the return code of the currently depressed touch key at the RS232.

Example: \$1B \$54 \$57

## ESC U E x1 y1 n1

## Load image from EEPROM

Displays the image saved in the EEPROM with the number **n1** (0..255) at position **x1,y1**.

Example: \$1B \$55 \$45 \$02 \$03 \$0E - Displays image number 14 from the EEPROM at position 2,3.

## ESC U L x1 y1 data...

## Upload image

Displays an image at position **x1,y1**.

**data..:**

- 1 byte for the image width in pixels
- 1 byte for the image height in pixels
- Image data: number =  $((\text{width}+7) / 8) * \text{height bytes}$ .

1 byte stands for 8 horizontal pixels on the screen; 0=white, 1=black;  
MSB: left, LSB: right; the image is stored from the top down.  
The BMP2BLH.EXE program on the EA DISK240 floppy disk available as an accessory creates the image data, including the width and height, from monochrome Windows bitmap graphics (\*.BMP).

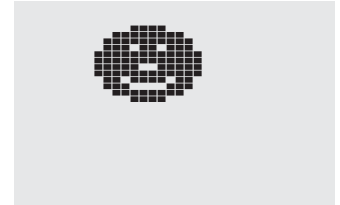

Example:

```
$1B $55 $4C $09 $04 $0C $0C
$0F $00 $3F $C0 $7F $E0 $76 $E0 $FF $F0 $FF $F0
$F1 $F0 $FF $F0 $6F $60 $70 $E0 $3F $C0 $0F $00
```

Loads the adjacent image at position 9,4.

		Bit no.				Bit no.									
		7	6	5	4	3	2	1	0	7	6	5	4		
Byte 1														Byte 2	
Byte 3														Byte 4	
Byte 5														Byte 6	
Byte 7														Byte 8	
Byte 9														Byte 10	
Byte 11														Byte 12	
Byte 13														Byte 14	
Byte 15														Byte 16	
Byte 17														Byte 18	
Byte 19														Byte 20	
Byte 21														Byte 22	
Byte 23														Byte 24	

## ESC V n1

## Set graphics mode

Sets the link mode **n1** for the following graphics functions: ESC P (Set point), ESC G (Draw straight line), ESC W (Continue straight line), ESC R R (Draw rectangle), ESC R N (Draw rounded rectangle), ESC R M (Fill area with pattern).

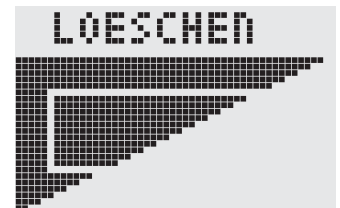
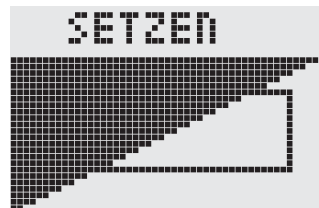

Example: \$1B \$56 \$03

Sets the link mode to inverse.

By way of example, a rectangle is drawn alongside with the link modes set, delete and inverse on an existing background.

Link mode n1:

- 1 = set: black pixels irrespective of the previous value (OR)
- 2 = delete: white pixels irrespective of the previous value
- 3 = inverse: changes black pixels to white pixels and vice versa (EXOR)
- 4 = replace: deletes the background and sets black pixels; only area with fill pattern 'pat'
- 5 = inverse replace: fills the background and sets white pixels; only area with fill pattern 'pat'

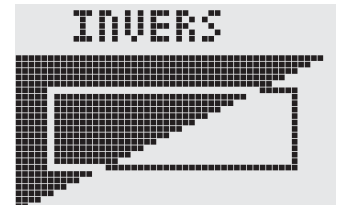

## ESC W x1 y1

## Continue straight line

Continues a straight line from the last end or point drawn to **x1,y1** taking into account the set graphics mode 'V'.

Example:

```
$1B $47 $00 $00 $10 $04
$1B $57 $16 $1B
$1B $57 $30 $0F
```

A straight line is drawn from 0,0 to 16,4. It is then continued to 22,27 and to 48,15.

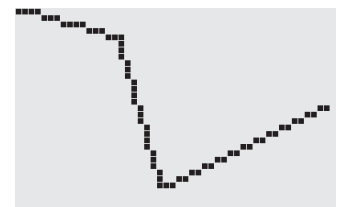

## ESC X n1

## Wait/pause

This command suspends the KIT240 for **n1/10** seconds.

Example: \$1B \$58 \$0A - After this command KIT240 waits for 1 second before next command is processed.

## ESC Y R n1

## Read input port

Reads in the input port (**n1=1..8 = IN1..IN8**). When **n1=0**, all the inputs are read in as 8-bit binary values (MSB:IN8...IN1:LSB); see application on page 5. Important: The optocouplers invert the input logic (input open: 1). The command "ESC Y I 1" puts this right (input open: 0).

Example: \$1B \$59 \$52 \$03 - Reads in port IN3. The result is sent via RS232.

## ELECTRONIC ASSEMBLY

**ESC Y W n1 n2****Write output port**

Changes the output port ( $n1=1..8 = \text{OUT1}..\text{OUT8}$ ) to the value  $n2$  (0=low level; 1=high level; 2=invert port). When  $n1=0$ , all the outputs are output as a binary value  $n2$  (MSB:OUT8...OUT1:LSB); see application on page 5.

Example: \$1B \$59 \$57 \$02 \$01

Switches the output port OUT2 to high level.

**ESC Y A n1****Automatic port query on/off**

Each change at the input port (8-bit binary value IN8..IN1) can call a port macro (0..255). This command activates ( $n1=1$ ) or deactivates ( $n1=0$ ) the automatic port query. After power-on, the current port status is read and the associated port macro executed immediately.

Example: \$1B \$59 \$41 \$01

Activates the automatic port query and executes the associated port macro.

**ESC Y I n1****Invert input port**

This command allows the logic of the input port to be inverted ( $n1=0$  for normal or  $n1=1$  for inverse). This is useful with the optocoupler inputs, for example.

Example: \$1B \$59 \$49 \$01

Inverts the input port logic.

**ESC Y L n1****(from Rev. B) Backlight On/Off**

$n1=0$  switches backlight off and  $n1=1$  will switch on backlight permanently;  $n1=2$  switches B./L. from On->Off and from Off->On.  $n1=3..255$  switches B./L. on for a periode of  $n1/10$  seconds. Is a resistor (e.g. 47 ohms) is inserted at  $R_{\text{Off}}$  position B./L. will never switch off complete but with reduced brightness (2 steps of brightness).

Example: \$1B \$59 \$4C \$64

will switch on backlight for a periode of 10 sec.

**ESC Z L/Z/R x1 y1 text... NUL**

Writes the string **text...** left justified (**L**), centered (**Z**) or right justified (**R**) at position  $x1$  taking into account the set text mode (**ESC L**). Multi-line text can also be output, with the lines separated by the character '|' ( $=\$7C$ ). The string must be concluded with **NUL**= \$00. Position  $y1$  is the upper edge of the 1st line.

Example 1: Writes the text "Left|Ok" left justified at 0,0.

\$1B \$5A \$4C \$00 \$00 \$4C \$65 \$66 \$74 \$7C \$4F \$6B \$00

Example 2: Writes the text "Center|Ok" centered at 25,0.

\$1B \$5A \$5A \$19 \$00 \$43 \$65 \$6E \$74 \$65 \$72 \$7C \$4F \$6B \$00

Example 3: Writes the text "Right|Ok" right justified at 49,0.

\$1B \$5A \$52 \$31 \$00 \$52 \$69 \$67 \$68 \$74 \$7C \$4F \$6B \$00

**Horizontal string**

Left|  
Ok

Center|  
Ok

Right|  
Ok

**ESC Z O/M/U x1 y1 text... NUL****Vertical string**

Writes the string **text...** rotated by 90° degrees top justified (**O**), vertically centered (**M**) or bottom justified (**U**) at position  $y1$  taking into account the text mode (**ESC L**). Multi-line text can also be output, with the lines separated by the character '|' ( $=\$7C$ ). The string must be concluded with **NUL**= \$00. Position  $x1$  is the right edge of the 1st line.

Example 1: Writes the text "Top|Ok" top justified at 49,0.

\$1B \$5A \$4F \$31 \$00 \$54 \$6F \$70 \$7C \$4F \$6B \$00

Example 2: Writes the text "Mid|Ok" vertically centered at 49,15.

\$1B \$5A \$4D \$31 \$0F \$4D \$69 \$64 \$7C \$4F \$6B \$00

Example 3: Writes the text "Bot|Ok" bottom justified at 49,31.

\$1B \$5A \$55 \$31 \$1F \$42 \$6F \$74 \$7C \$4F \$6B \$00

O-  
x|  
g  
8

O-  
x|  
g  
8

O-  
x|  
g  
8

# EA KIT240-7

## DIMENSIONS WITHOUT TOUCH PANEL

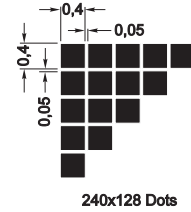
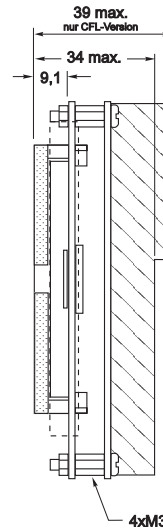
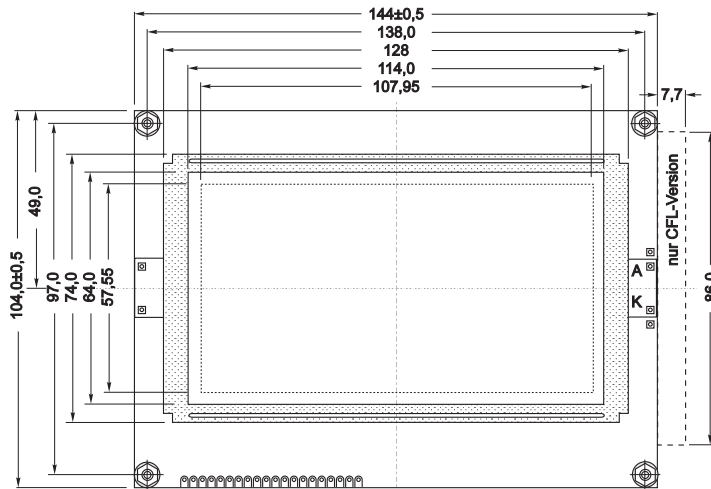

All dimensions in mm

## DIMENSIONS WITH TOUCH PANEL

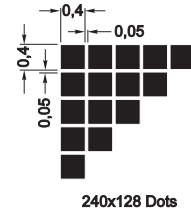
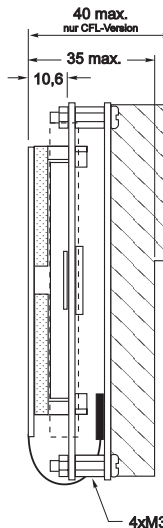
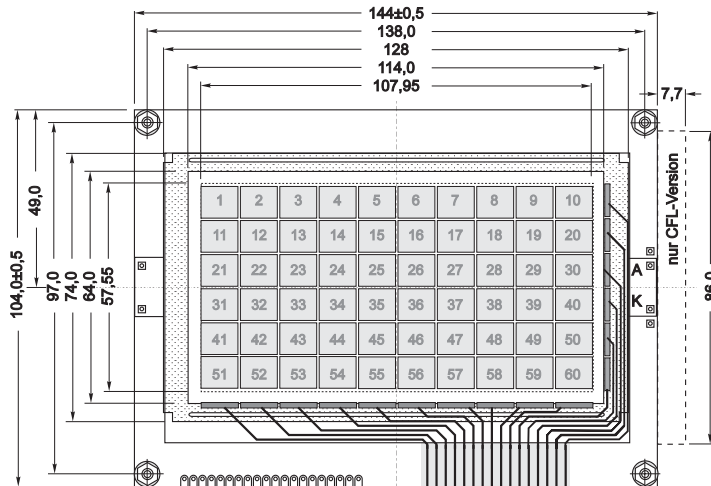

All dimensions in mm

## EA 0FP240-7 FRONT PANEL

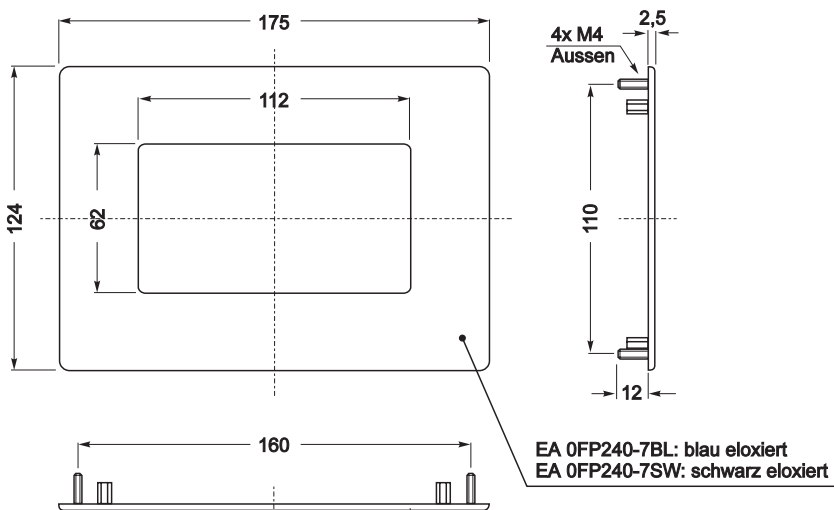

## PANEL CUTOUT

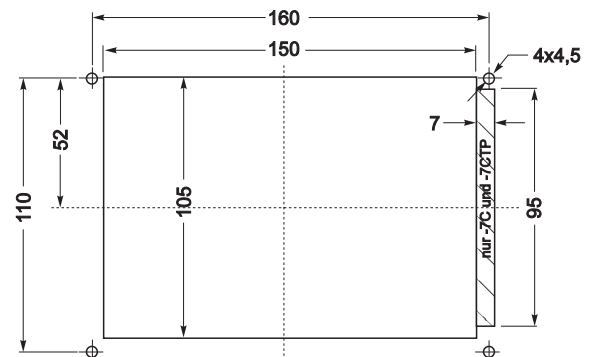

All dimensions in mm