

## HS4040xAQx Series

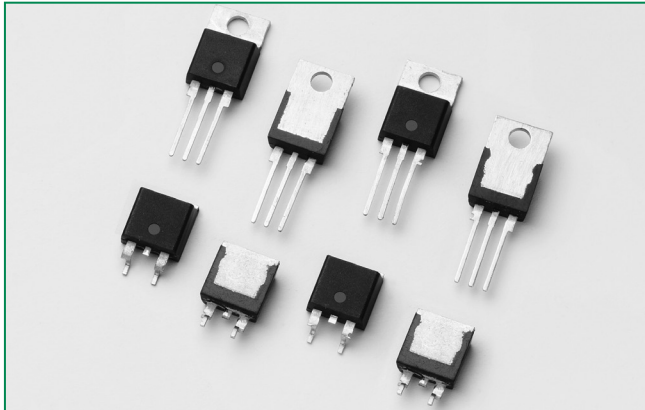

### Description

The HS4040xAQx series of SCRs offer fast turn-off time (tq) characteristics required for applications such as power inverters, switching regulator, and high frequency pulse circuits.

These fast turn-off time SCRs offer high dv/dt and high di/dt characteristics required in higher frequency (>1000 PPS) switching circuits and a higher temperature environment.

### Features & Benefits

- RoHS compliant
- Voltage capability up to 400 V
- Surge capability up to 520 A
- TO-220 and TO-263 packages
- AEC-Q101 Fully compliant
- 150°C maximum junction temperature

### Applications

Fast turn-off time SCRs are ideal for multi phase voltage regulator circuits, DC/AC inverters, and higher frequency pulsing power supplies.

### Main Features

Symbol	Value	Unit
$I_{T(RMS)}$	40	A
$V_{DRM}/V_{RRM}$	400	V
$I_{GT}$	15 to 65	mA

### Schematic Symbol

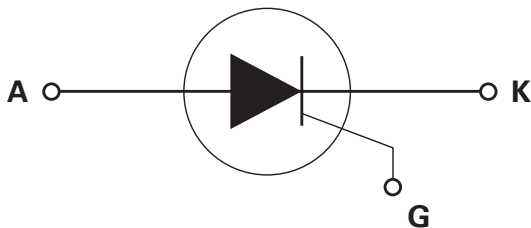

### Absolute Maximum Ratings

Symbol	Parameter	Test Conditions	Value	Unit
$I_{T(RMS)}$	RMS on-state current	$T_c = 115^\circ\text{C}$	40	A
$I_{T(AV)}$	Average on-state current	$T_c = 115^\circ\text{C}$	25.0	A
$I_{TSM}$	Peak non-repetitive surge current	single half cycle; f = 50Hz; $T_j$ (initial) = 25°C	430	A
		single half cycle; f = 60Hz; $T_j$ (initial) = 25°C	520	
$I^2t$	$I^2t$ Value for fusing	$t_p = 8.3$ ms	1122	A <sup>2</sup> s
di/dt	Critical rate of rise of on-state current	f = 60Hz; $T_j = 150^\circ\text{C}$	175	A/ $\mu\text{s}$
$I_{GM}$	Peak gate current	$T_j = 150^\circ\text{C}$	3.5	A
$P_{G(AV)}$	Average gate power dissipation	$T_j = 150^\circ\text{C}$	0.8	W
$T_{stg}$	Storage temperature range		-40 to 150	°C
$T_j$	Operating junction temperature range		-40 to 150	°C
$V_{DSM}/V_{RSM}$	Peak non-repetitive blocking voltage	Pw=100 $\mu\text{s}$	500	V

**Electrical Characteristics (T<sub>J</sub> = 25°C, unless otherwise specified)**

Symbol	Test Conditions		HS4040xAQ	HS4040xAQ2	HS4040xAQ3	Unit
I <sub>GT</sub>	V <sub>D</sub> = 12V; R <sub>L</sub> = 30 Ω	MAX.	35	45	65	mA
		MIN.	15	30	38	
V <sub>GT</sub>		MAX.	1.5			V
I <sub>GT</sub>	V <sub>D</sub> = 12V; R <sub>L</sub> = 30Ω; T <sub>J</sub> = -40°C	MAX.	75	95	160	mA
dv/dt	V <sub>D</sub> = V <sub>DRM'</sub> ; gate open; T <sub>J</sub> = 150°C	MIN.	550			V/μs
V <sub>GD</sub>	V <sub>D</sub> = V <sub>DRM'</sub> ; R <sub>L</sub> = 3.3 kΩ; T <sub>J</sub> = 150°C	MIN.	0.2			V
I <sub>H</sub>	I <sub>T</sub> = 400mA (initial)	MAX.	70	120	200	mA
t <sub>q</sub>	I <sub>T</sub> =0.5A; t <sub>p</sub> =50μs; dv/dt=5V/μs; di/dt=-30A/μs	MAX.	15	12	5	μs
t <sub>gt</sub>	I <sub>G</sub> = 2 x I <sub>GT</sub> ; PW = 15μs; I <sub>T</sub> = 80A	TYP.	3.0			μs

**Static Characteristics**

Symbol	Test Conditions		HS4040xAQ	HS4040xAQ2	HS4040xAQ3	Unit
V <sub>TM</sub>	I <sub>T</sub> = 80A; t <sub>p</sub> = 380μs	MAX.	1.6		1.8	V
I <sub>DRM</sub> / I <sub>RRM</sub>	V <sub>DRM</sub> / V <sub>RRM</sub>	T <sub>J</sub> = 25°C	10			μA
		T <sub>J</sub> = 125°C	2000			
		T <sub>J</sub> = 150°C	4000			

**Thermal Resistances**

Symbol	Parameter	Value	Unit
R <sub>θ(J-C)</sub>	Junction to case (AC)	0.6	°C/W

**Figure 1: Normalized DC Holding Current vs. Junction Temperature**

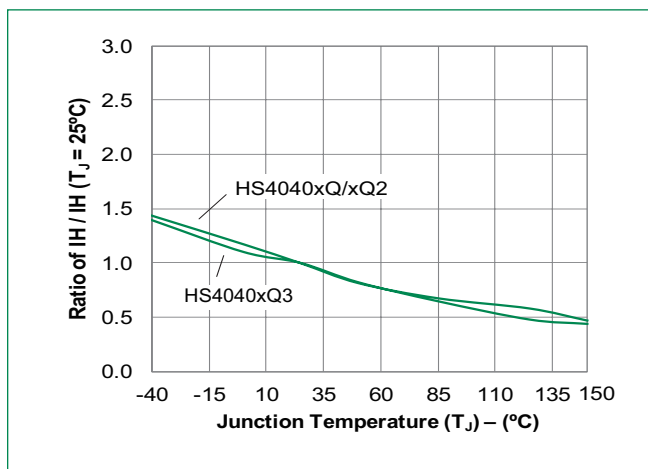

**Figure 2: Normalized DC Gate Trigger Current vs. Junction Temperature**

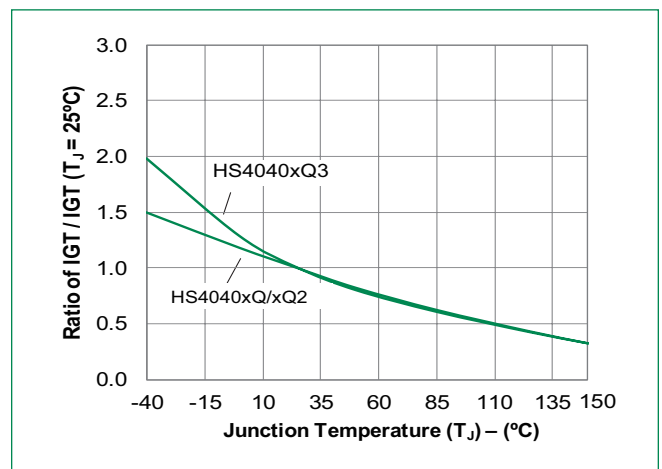

**Figure 3: Normalized DC Gate Trigger Voltage vs. Junction Temperature**

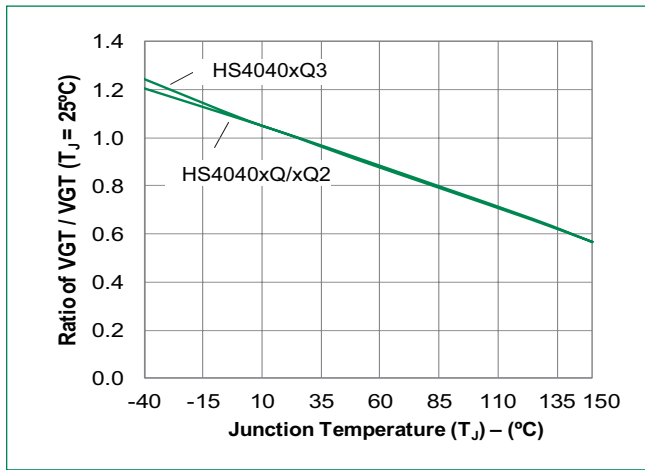

**Figure 4: On-State Current vs. On-State Voltage (Typical)**

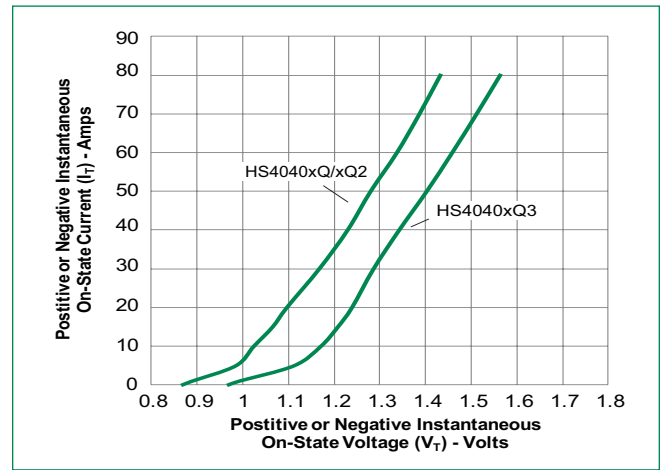

**Figure 5: Power Dissipation (Typical) vs. RMS On-State Current**

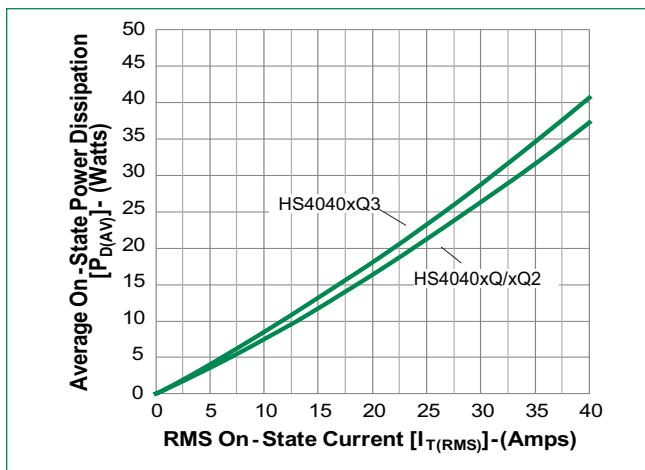

**Figure 6: Maximum Allowable Case Temperature vs. RMS On-State Current**

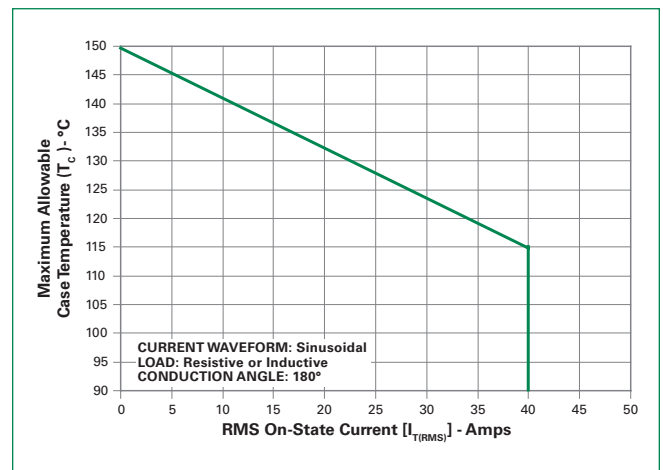

**Figure 7: Maximum Allowable Case Temperature vs. Average On-State Current**

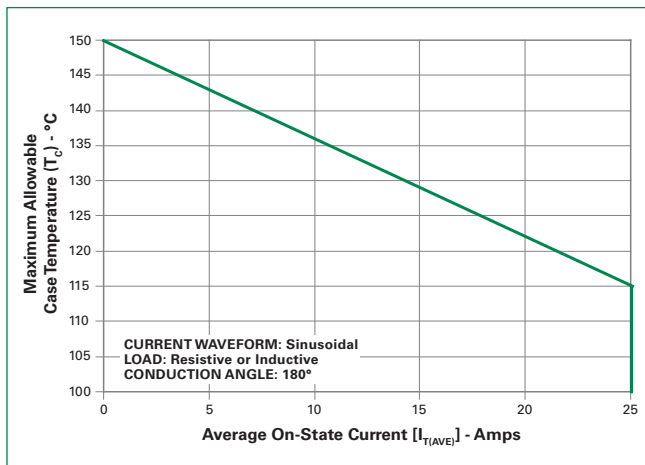

**Figure 8: Peak Capacitor Discharge Current**

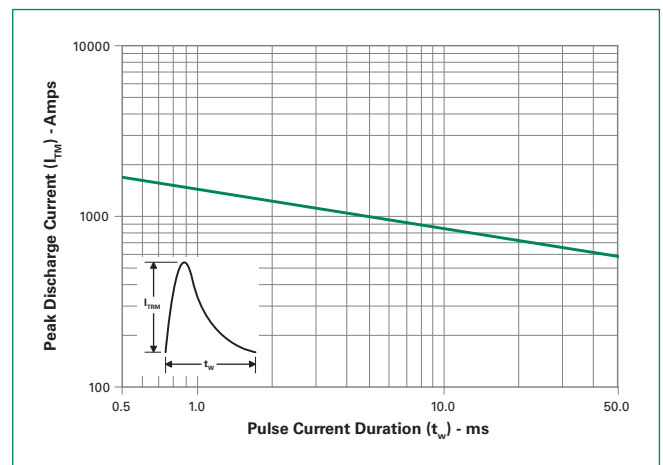

**Figure 9: Peak Capacitor Discharge Current Derating**

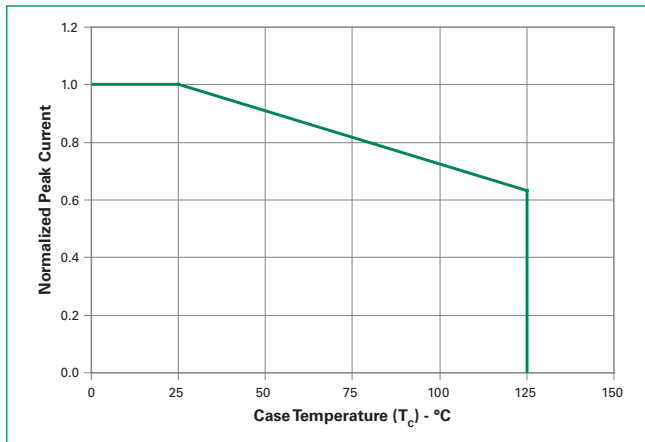

**Figure 10: Surge Peak On-State Current vs. Number of Cycles**

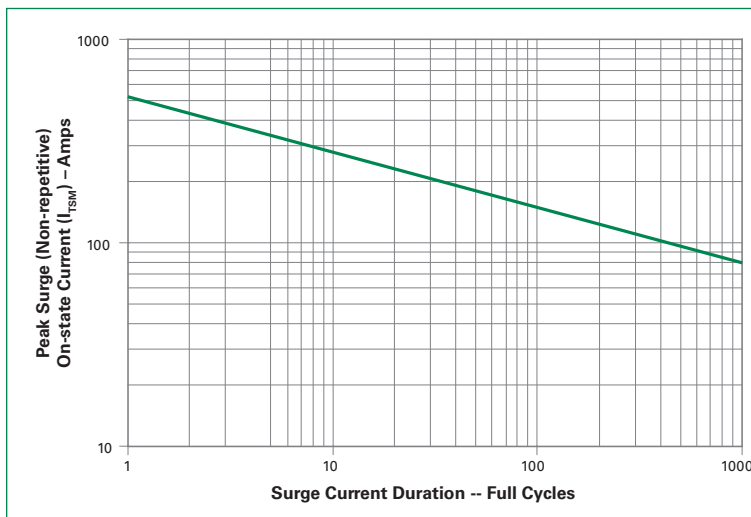

SUPPLY FREQUENCY: 60 Hz Sinusoidal  
LOAD: Resistive  
RMS On-State Current: [I<sub>T(RMS)</sub>]: Maximum Rated Value at Specified Case Temperature

Notes:  
1. Gate control may be lost during and immediately following surge current interval.  
2. Overload may not be repeated until junction temperature has returned to steady-state rated value.

**Soldering Parameters**

Reflow Condition	Pb – Free assembly	
Pre Heat	- Temperature Min (T <sub>s(min)</sub> )	150°C
	- Temperature Max (T <sub>s(max)</sub> )	200°C
	- Time (min to max) (t <sub>s</sub> )	60 – 180 secs
Average ramp up rate (Liquidus Temp (T <sub>L</sub> ) to peak)		5°C/second max
T <sub>s(max)</sub> to T <sub>L</sub> - Ramp-up Rate		5°C/second max
Reflow	- Temperature (T <sub>L</sub> ) (Liquidus)	217°C
	- Temperature (t <sub>L</sub> )	60 – 150 seconds
Peak Temperature (T <sub>p</sub> )		260 <sup>+0/-5</sup> °C
Time within 5°C of actual peak Temperature (t <sub>p</sub> )		20 – 40 seconds
Ramp-down Rate		5°C/second max
Time 25°C to peak Temperature (T <sub>p</sub> )		8 minutes Max.
Do not exceed		280°C

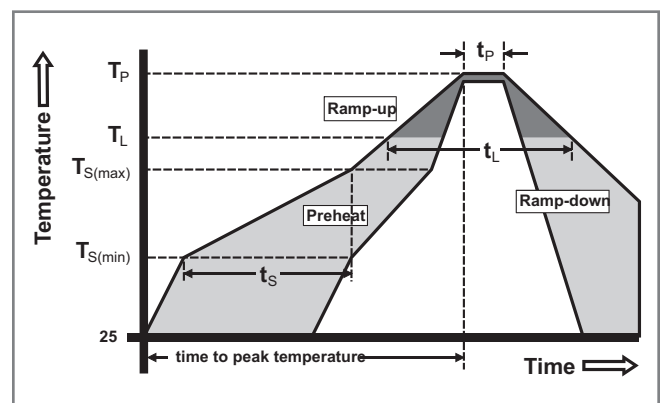

**Physical Specifications**

<b>Terminal Finish</b>	100% Matte Tin-plated
<b>Body Material</b>	UL recognized epoxy meeting flammability classification V-0
<b>Lead Material</b>	Copper Alloy

**Design Considerations**

Careful selection of the correct device for the application's operating parameters and environment will go a long way toward extending the operating life of the Thyristor. Good design practice should limit the maximum continuous current through the main terminals to 75% of the device rating. Other ways to ensure long life for a power discrete semiconductor are proper heat sinking and selection of voltage ratings for worst case conditions. Overheating, overvoltage (including dv/dt), and surge currents are the main killers of semiconductors. Correct mounting, soldering, and forming of the leads also help protect against component damage.

**Environmental Specifications**

Test	Specifications and Conditions
<b>AC Blocking</b>	MIL-STD-750, M-1040, Cond A Applied Peak AC voltage @ 150°C for 1008 hours
<b>Biased Temperature &amp; Humidity</b>	EIA / JEDEC, JESD22-A101 1008 hours; 320V - DC: 85°C; 85% rel humidity
<b>Temperature Cycling</b>	JESD22 A-104 Appendix 6 -55°C to 150°C, 15-minute dwell, 1000 cycles
<b>Intermittent Operational Life</b>	T <sub>A</sub> =25C, ΔT <sub>J</sub> ≥ 100°C, 1008hrs
<b>Autoclave (Pressure Cooker Test)</b>	EIA/JEDEC: JESD22-A102 121°C, 100%RH, 15psig, 96hours
<b>Resistance to Solder Heat</b>	JESD22 A-111: 260°C, 10 seconds
<b>Solderability</b>	ANSI/J-STD-002, category 3, Test A

**Dimensions — TO-220AB (R-Package) — Non-Isolated Mounting Tab Common with Center Lead**

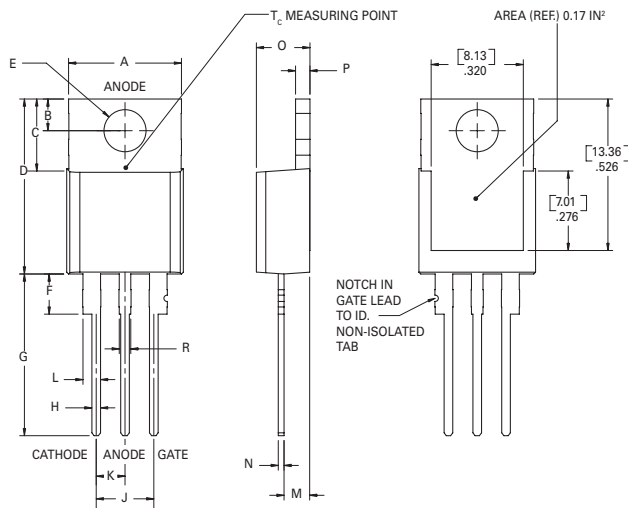

Note: Maximum torque to be applied to mounting tab is 8 in.-lbs. (0.904 Nm).

Dimension	Inches		Millimeters	
	Min	Max	Min	Max
A	0.380	0.420	9.65	10.67
B	0.105	0.115	2.67	2.92
C	0.230	0.250	5.84	6.35
D	0.590	0.620	14.99	15.75
E	0.142	0.147	3.61	3.73
F	0.110	0.130	2.79	3.30
G	0.540	0.575	13.72	14.61
H	0.025	0.035	0.64	0.89
J	0.195	0.205	4.95	5.21
K	0.095	0.105	2.41	2.67
L	0.060	0.075	1.52	1.91
M	0.085	0.095	2.16	2.41
N	0.018	0.024	0.46	0.61
O	0.178	0.188	4.52	4.78
P	0.045	0.060	1.14	1.52
R	0.038	0.048	0.97	1.22

**Dimensions – TO- 263 (N-package) – D<sup>2</sup>-Pak Surface Mount**

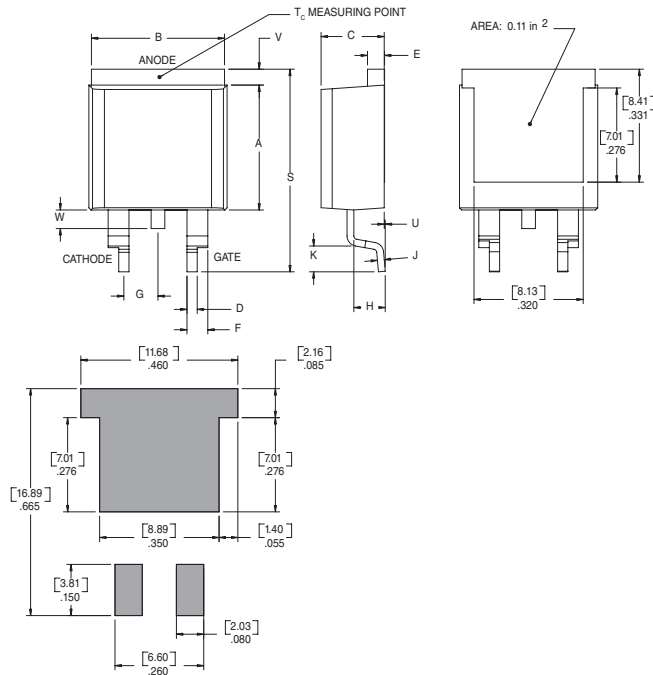

Dimension	Inches		Millimeters	
	Min	Max	Min	Max
A	0.360	0.370	9.14	9.40
B	0.380	0.420	9.65	10.67
C	0.178	0.188	4.52	4.78
D	0.025	0.035	0.63	0.89
E	0.048	0.055	1.22	1.40
F	0.060	0.075	1.52	1.91
G	0.095	0.105	2.41	2.67
H	0.083	0.093	2.11	2.36
J	0.018	0.024	0.46	0.61
K	0.090	0.110	2.29	2.79
S	0.590	0.625	14.99	15.87
V	0.035	0.045	0.89	1.14
U	0.002	0.010	0.05	0.25
W	0.040	0.070	1.02	1.78

**Part Numbering System**

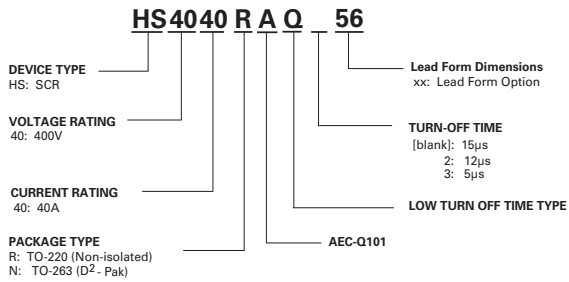

**Part Marking System**

TO-220 AB - (R Package)  
TO-263 (N Package)

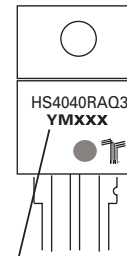

**Date Code Marking**  
Y: Year Code  
M: Month Code  
XXX: Lot Trace Code

**Product Selector**

Part Number	Voltage	Gate Sensitivity	Type	Package
	400V			
HS4040RAQ	X	15-35	Standard SCR	TO-220AB
HS4040NAQ	X	15-35	Standard SCR	TO-263
HS4040RAQ2	X	30-45	Standard SCR	TO-220AB
HS4040NAQ2	X	30-45	Standard SCR	TO-263
HS4040RAQ3	X	38-65	Standard SCR	TO-220AB
HS4040NAQ3	X	38-65	Standard SCR	TO-263

**Packing Options**

Part Number	Marking	Weight	Packing Mode	Base Quantity
HS4040RAQTP	HS4040RAQ	2.2g	Tube	500 (50 per tube)
HS4040RAQ2TP	HS4040RAQ2	2.2g	Tube	500 (50 per tube)
HS4040RAQ3TP	HS4040RAQ3	2.2g	Tube	500 (50 per tube)
HS4040NAQRP	HS4040NAQ	1.6g	Embossed Carrier	500
HS4040NAQ2RP	HS4040NAQ2	1.6g	Embossed Carrier	500
HS4040NAQ3RP	HS4040NAQ3	1.6g	Embossed Carrier	500

**Reel Pack (RP) for TO-263 Embossed Carrier Specifications**

Meets all EIA-481-2 Standards

