

## FEATURES

- Low Cost
- Current Feedback Amplifiers
- Differential Gain: 0.03%,  $R_L = 150\Omega$ ,  $V_S = \pm 5V$
- Differential Phase: 0.28°,  $R_L = 150\Omega$ ,  $V_S = \pm 5V$
- Flat to 30MHz, 0.1dB
- 90MHz Bandwidth on  $\pm 5V$
- Wide Supply Range:  $\pm 2V(4V)$  to  $\pm 14V(28V)$
- Low Power: 60mW per Amplifier at  $\pm 5V$

## APPLICATIONS

- RGB Cable Drivers
- Composite Video Cable Drivers
- Gain Blocks in IF Stages

## DESCRIPTION

The LT1253 is a low cost dual current feedback amplifier for video applications. The LT1254 is a quad version of the LT1253. The amplifiers are completely isolated except for the power supply pins and therefore have excellent isolation, over 94dB at 5MHz. Dual and quad amplifiers significantly reduce costs compared with singles; the number of insertions is reduced and fewer supply bypass capacitors are required. In addition, these duals and quads cost less per amplifier than single video amplifiers.

The LT1253/LT1254 amplifiers are ideal for driving low impedance loads such as cables and filters. The wide bandwidth and high slew rate of these amplifiers make driving RGB signals between PCs and workstations easy. The excellent linearity of these amplifiers makes them ideal for composite video.

The LT1253 is available in 8-pin DIPs and the S8 surface mount package. The LT1254 is available in 14-pin DIPs and the S14 surface mount package. Both parts have the industry standard dual and quad op amp pin out. For higher performance, see the LT1229/LT1230.

## TYPICAL APPLICATION

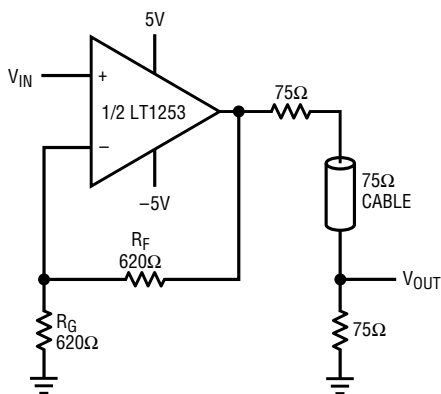

$$A_V = 1 + \frac{R_F}{R_G} \quad BW = 90\text{MHz}$$

AT AMPLIFIER OUTPUT.  
6dB LESS AT  $V_{OUT}$ .

LT1253/54 • TA01

Transient Response

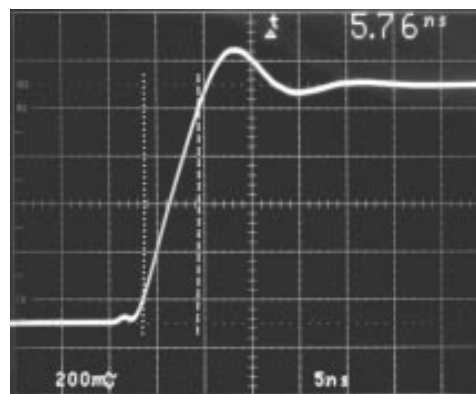
 $V_S = \pm 5V$   
 $A_V = 2$   
 $R_L = 150\Omega$   
 $V_0 = 1V$ 

LT1253/54 • TA02

# LT1253/LT1254

## ABSOLUTE MAXIMUM RATINGS

Total Supply Voltage ( $V^+$ to $V^-$ ) .....	28V	Storage Temperature Range .....	-65°C to 150°C
Input Current .....	±15mA	Junction Temperature (Note 2) .....	150°C
Output Short-Circuit Duration (Note 1) .....	Continuous	Lead Temperature (Soldering, 10 sec) .....	300°C
Operating Temperature Range			
LT1253C, LT1254C .....	0°C to 70°C		

## PACKAGE/ORDER INFORMATION

<p>N8 PACKAGE 8-LEAD PLASTIC DIP</p> <p>S8 PACKAGE 8-LEAD PLASTIC SOIC</p> <p><math>T_{JMAX} = 150^{\circ}C, \theta_{JA} = 100^{\circ}C/W</math> (N) <math>T_{JMAX} = 150^{\circ}C, \theta_{JA} = 150^{\circ}C/W</math> (S)</p>	ORDER PART NUMBER	<p>N PACKAGE 14-LEAD PLASTIC DIP</p> <p>S PACKAGE 14-LEAD PLASTIC SOIC</p> <p><math>T_{JMAX} = 150^{\circ}C, \theta_{JA} = 70^{\circ}C/W</math> (N) <math>T_{JMAX} = 150^{\circ}C, \theta_{JA} = 100^{\circ}C/W</math> (S)</p>	ORDER PART NUMBER
	LT1253CN8 LT1253CS8		LT1254CN LT1254CS
	S8 PART MARKING		
	1253		

## ELECTRICAL CHARACTERISTICS $0^{\circ}C \leq T_A \leq 70^{\circ}C, V_S = \pm 5V$ to $\pm 12V$ , unless otherwise noted.

Symbol	Parameter	CONDITIONS	MIN	TYP	MAX	UNITS
$V_{OS}$	Input Offset Voltage			5	15	mV
$+I_B$	Noninverting Bias Current			1	15	$\mu A$
$-I_B$	Inverting Bias Current			20	100	$\mu A$
$A_{VOL}$	Large-Signal Voltage Gain	$V_S = \pm 5V, V_O = \pm 2V, R_L = 150\Omega$	560	1500		V/V
PSRR	Power Supply Rejection Ratio	$V_S = \pm 3V$ to $\pm 12V$	60	70		dB
CMRR	Common-Mode Rejection Ratio	$V_S = \pm 5V, V_{CM} = \pm 2V$	55	65		dB
$V_{OUT}$	Maximum Output Voltage Swing	$V_S = \pm 12V, R_L = 500\Omega$ $V_S = \pm 5V, R_L = 150\Omega$	±7.0 ±2.5	±10.5 ±3.7		V V
$I_{OUT}$	Maximum Output Current		30	55		mA
$I_S$	Supply Current	Per Amplifier		6	11	mA
$R_{IN}$	Input Resistance		1	10		M $\Omega$
$C_{IN}$	Input Capacitance			3		pF
	Power Supply Range	Dual Single	±2 4		±12 24	V V
	Channel Separation	$f = 10MHz$		88		dB
SR	Input Slew Rate	$A_V = 1$		125		V/ $\mu s$
	Output Slew Rate	$A_V = 2$		250		V/ $\mu s$

**ELECTRICAL CHARACTERISTICS**  $0^{\circ}\text{C} \leq T_A \leq 70^{\circ}\text{C}$ ,  $V_S = \pm 5\text{V}$  to  $\pm 12\text{V}$ , unless otherwise noted.

Symbol	Parameter	CONDITIONS	MIN	TYP	MAX	UNITS
$t_r$	Small-Signal Rise Time	$V_S = \pm 12\text{V}$ , $A_V = 2$		3.5		ns
	Rise and Fall Time	$V_S = \pm 5\text{V}$ , $A_V = 2$ , $V_{OUT} = 1V_{P-P}$		5.8		ns
$t_p$	Propagation Delay	$V_S = \pm 5\text{V}$ , $A_V = 2$		3.5		ns

**Note 1:** A heat sink may be required to keep the junction temperature below absolute maximum when the output is shorted indefinitely.

**Note 2:**  $T_J$  is calculated from the ambient temperature  $T_A$  and power dissipation  $P_D$  according to the following formulas:

$$\begin{aligned} \text{LT1253CN8: } T_J &= T_A + (P_D \times 100^{\circ}\text{C/W}) \\ \text{LT1253CS8: } T_J &= T_A + (P_D \times 150^{\circ}\text{C/W}) \\ \text{LT1254CN: } T_J &= T_A + (P_D \times 70^{\circ}\text{C/W}) \\ \text{LT1254CS: } T_J &= T_A + (P_D \times 100^{\circ}\text{C/W}) \end{aligned}$$

**TYPICAL AC PERFORMANCE**

**BANDWIDTH**

$V_S$	$A_V$	$R_L$	$R_F$	$R_G$	Small Signal -3dB BW (MHz)	Small Signal -0.1dB BW (MHz)	Small Signal Peaking (dB)
$\pm 12$	1	1000	1100	None	270	51	3.4
$\pm 12$	1	150	1000	None	204	48	1.3
$\pm 12$	-1	1000	750	150	110	59	0.1
$\pm 12$	-1	150	768	768	89	50	0.1
$\pm 12$	2	1000	715	715	179	76	0.3
$\pm 12$	2	150	715	715	117	62	0
$\pm 12$	5	1000	680	180	106	42	0
$\pm 12$	5	150	680	180	90	47	0
$\pm 12$	10	1000	620	68.1	89	49	0.1
$\pm 12$	10	150	620	68.1	80	46	0.1
$\pm 5$	1	1000	787	None	218	53	1.5
$\pm 5$	1	150	787	None	158	91	0.1
$\pm 5$	-1	1000	715	715	76	28	0.1
$\pm 5$	-1	150	715	715	70	30	0.1
$\pm 5$	2	1000	620	620	117	58	0.1
$\pm 5$	2	150	620	620	92	52	0.1
$\pm 5$	5	1000	620	150	82	36	0
$\pm 5$	5	150	620	150	72	34	0
$\pm 5$	10	1000	562	61.9	70	35	0
$\pm 5$	10	150	562	61.9	65	28	0

**NTSC VIDEO (Note 1)**

$V_S$	$A_V$	$R_L$	$R_F$	$R_G$	DIFFERENTIAL GAIN	DIFFERENTIAL PHASE
$\pm 12$	2	1000	750	750	0.01%	0.03°
$\pm 12$	2	150	750	750	0.01%	0.12°
$\pm 5$	2	1000	750	750	0.03%	0.18°
$\pm 5$	2	150	750	750	0.03%	0.28°

**Note 1:** Differential Gain and Phase are measured using a Tektronix TSG 120 YC/NTSC signal generator and a Tektronix 1780R Video Measurement Set. The resolution of this equipment is 0.1% and 0.1°. Ten identical

amplifier stages were cascaded giving an effective resolution of 0.01% and 0.01°.

TYPICAL PERFORMANCE CHARACTERISTICS

Supply Current vs Supply Voltage

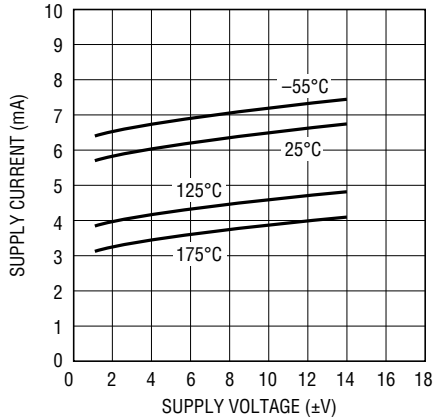

LT1253/54 • TPC01

Output Saturation Voltage vs Temperature

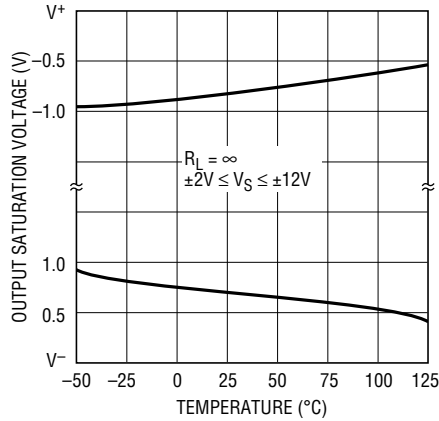

LT1253/54 • TPC02

Input Common-Mode Limit vs Temperature

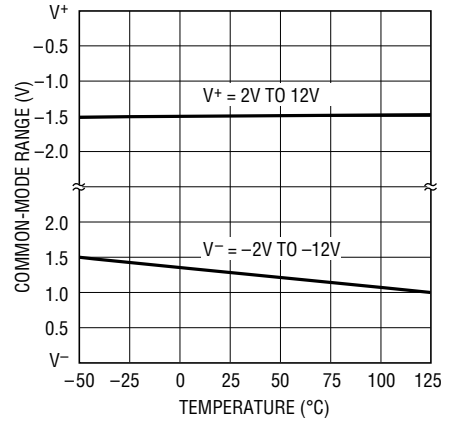

LT1253/54 • TPC03

Settling Time to 10mV vs Output Step

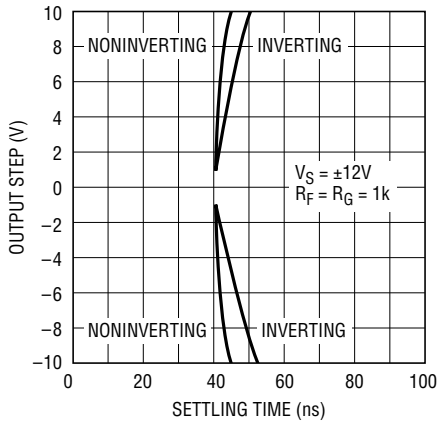

LT1253/54 • TPC04

2nd and 3rd Harmonic Distortion vs Frequency

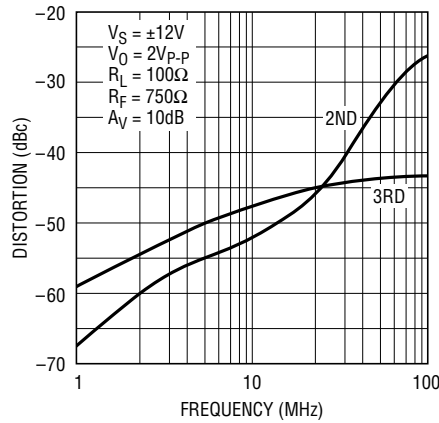

LT1253/54 • TPC05

Power Supply Rejection vs Frequency

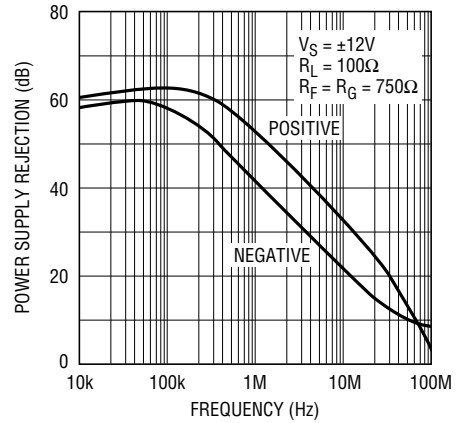

LT1253/54 • TPC06

Spot Noise Voltage and Current vs Frequency

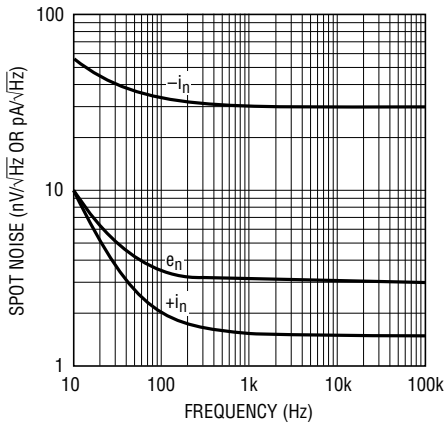

LT1253/54 • TPC07

Output Impedance vs Frequency

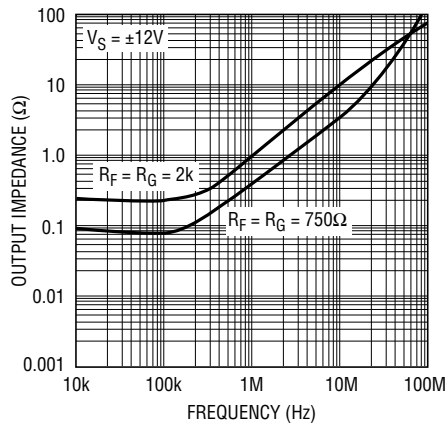

LT1253/54 • TPC08

Output Short-Circuit Current vs Temperature

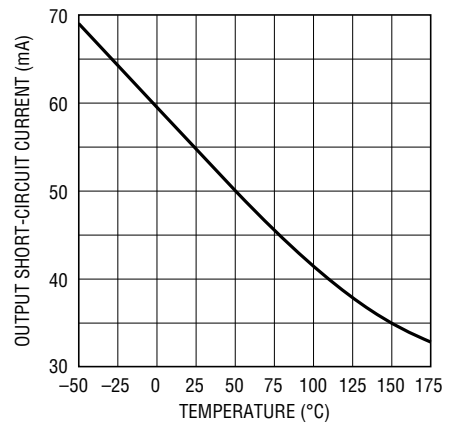

LT1253/54 • TPC09

# TYPICAL PERFORMANCE CHARACTERISTICS

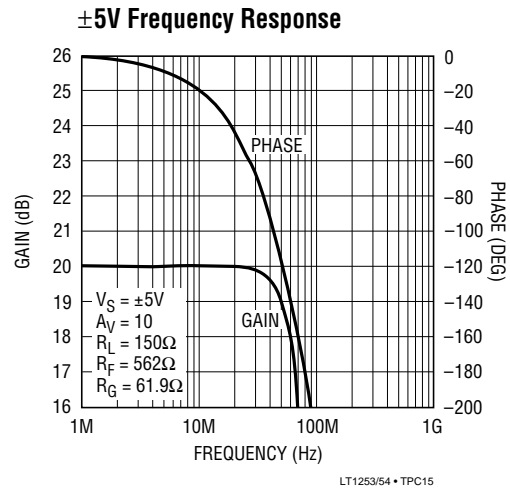
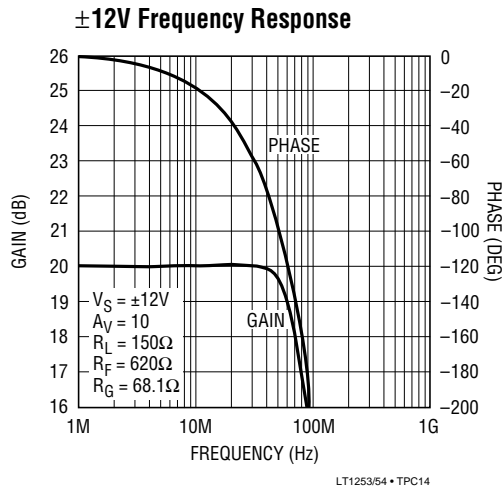
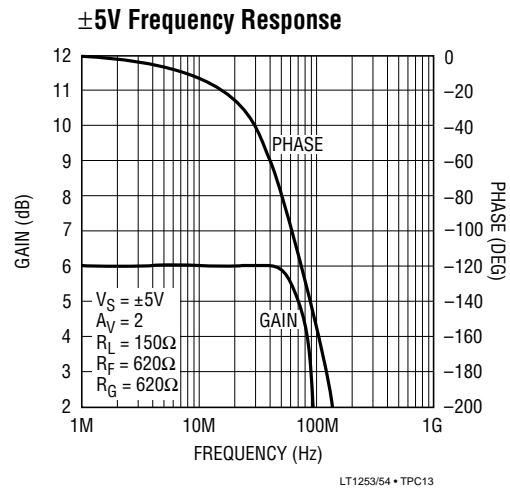
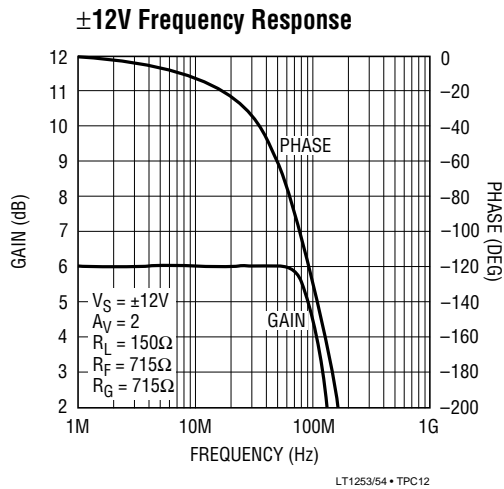
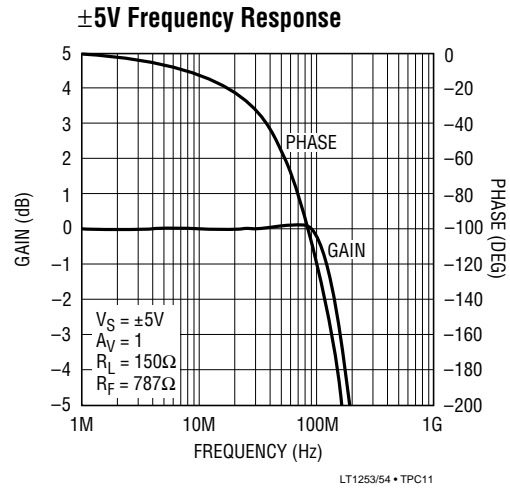
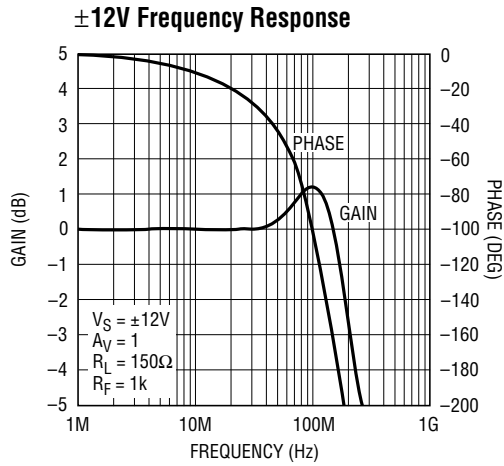

## TYPICAL PERFORMANCE CHARACTERISTICS

Transient Response



$V_S = \pm 5V$   $R_F = 787\Omega$   
 $A_V = 1$   $V_O = 1V$   
 $R_L = 150\Omega$

LT1253/54 • TPC16

Transient Response



$R_F = 562\Omega$   $V_S = \pm 5V$   
 $R_G = 61.9\Omega$   $A_V = 10$   
 $V_O = 1.5V$   $R_L = 150\Omega$

LT1253/54 • TPC17

## APPLICATIONS INFORMATION

### Power Dissipation

The LT1253/LT1254 amplifiers combine high speed and large output current drive into very small packages. Because these amplifiers work over a very wide supply range, it is possible to exceed the maximum junction temperature under certain conditions. To insure that the LT1253/LT1254 are used properly, we must calculate the worst case power dissipation, define the maximum ambient temperature, select the appropriate package and then calculate the maximum junction temperature.

The worst case amplifier power dissipation is the total of the quiescent current times the total power supply voltage plus the power in the IC due to the load. The quiescent supply current of the LT1253/LT1254 has a strong negative temperature coefficient. The supply current of each amplifier at 150°C is less than 7mA and typically is only 4.5mA. The power in the IC due to the load is a function of the output voltage, the supply voltage and load resistance. The worst case occurs when the output voltage is at half supply, if it can go that far, or its maximum value if it cannot reach half supply.

For example, let's calculate the worst case power dissipation in a video cable driver operating on a  $\pm 12V$  supply that delivers a maximum of 2V into 150 $\Omega$ .

$$P_{D\text{MAX}} = 2 \times V_S \times I_{S\text{MAX}} + (V_S - V_{O\text{MAX}}) \times V_{O\text{MAX}}/R_L$$

$$P_{D\text{MAX}} = 2 \times 12V \times 7\text{mA} + (12V - 2V) \times 2V/150 \\ = 0.168 + 0.133 = 0.301 \text{ Watt per Amp}$$

Now if that is the dual LT1253, the total power in the package is twice that, or 0.602W. We now must calculate how much the die temperature will rise above the ambient. The total power dissipation times the thermal resistance of the package gives the amount of temperature rise. For the above example, if we use the S8 surface mount package, the thermal resistance is 150°C/W junction to ambient in still air.

$$\text{Temperature Rise} = P_{D\text{MAX}} \times R_{\theta\text{JA}} = 0.602W \\ \times 150^\circ\text{C/W} = 90.3^\circ\text{C}$$

The maximum junction temperature allowed in the plastic package is 150°C. Therefore the maximum ambient allowed is the maximum junction temperature less the temperature rise.

$$\text{Maximum Ambient} = 150^\circ\text{C} - 90.3^\circ\text{C} = 59.7^\circ\text{C}$$

Note that this is less than the maximum of 70°C that is specified in the absolute maximum data listing. In order to use this package at the maximum ambient we must lower the supply voltage or reduce the output swing.

## APPLICATIONS INFORMATION

As a guideline to help in the selection of the LT1253/LT1254, the following table describes the maximum supply voltage that can be used with each part based on the following assumptions:

1. The maximum ambient is 70°C.
2. The load is a double-terminated video cable, 150Ω.
3. The maximum output voltage is 2V (peak or DC).

		MAX POWER at MAX T <sub>A</sub>
LT1253CN8	V <sub>S</sub> < ±14 (Abs Max)	0.800W
LT1253CS8	V <sub>S</sub> < ±10.6	0.533W
LT1254CN	V <sub>S</sub> < ±11.4	1.143W
LT1254CS	V <sub>S</sub> < ±7.6	0.727W

## SIMPLIFIED SCHEMATIC

One Amplifier



## PACKAGE DESCRIPTION Dimensions in inches (millimeters) unless otherwise noted.

N8 Package  
8-Lead Plastic DIP

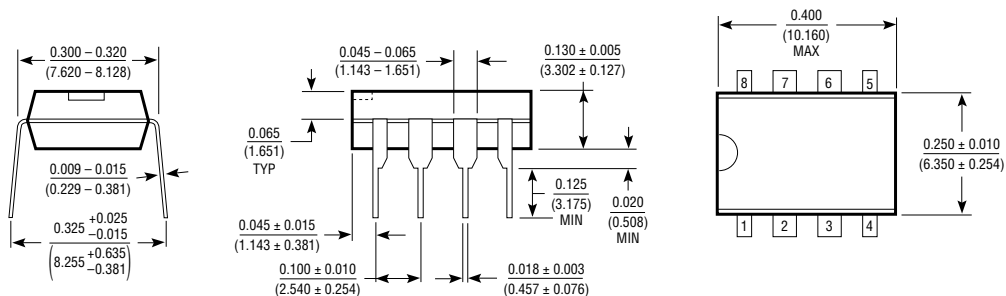

**PACKAGE DESCRIPTION** Dimensions in inches (millimeters) unless otherwise noted.

**N Package  
14-Lead Plastic DIP**

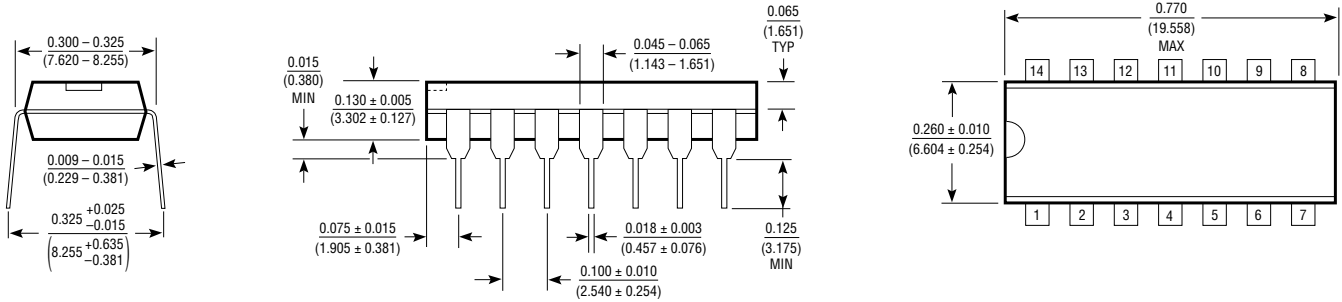

**S8 Package  
8-Lead SOIC**

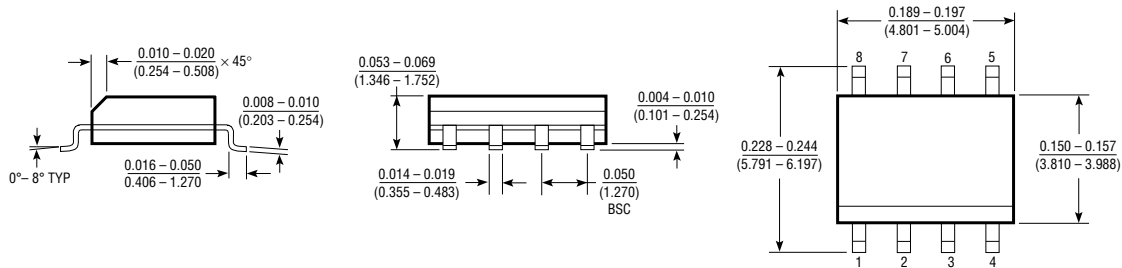

**S Package  
14-Lead SOIC**

