

Terminal Block Headers

158-P022EHDVCH-E, 158-P032EHDVCH-E, 158-P042EHDVCH-E,
 158-P052EHDVCH-E, 158-P062EHDVCH-E, 158-P072EHDVCH-E,
 158-P082EHDVCH-E, 158-P092EHDVCH-E, 158-P102EHDVCH-E,
 158-P112EHDVCH-E, 158-P122EHDVCH-E

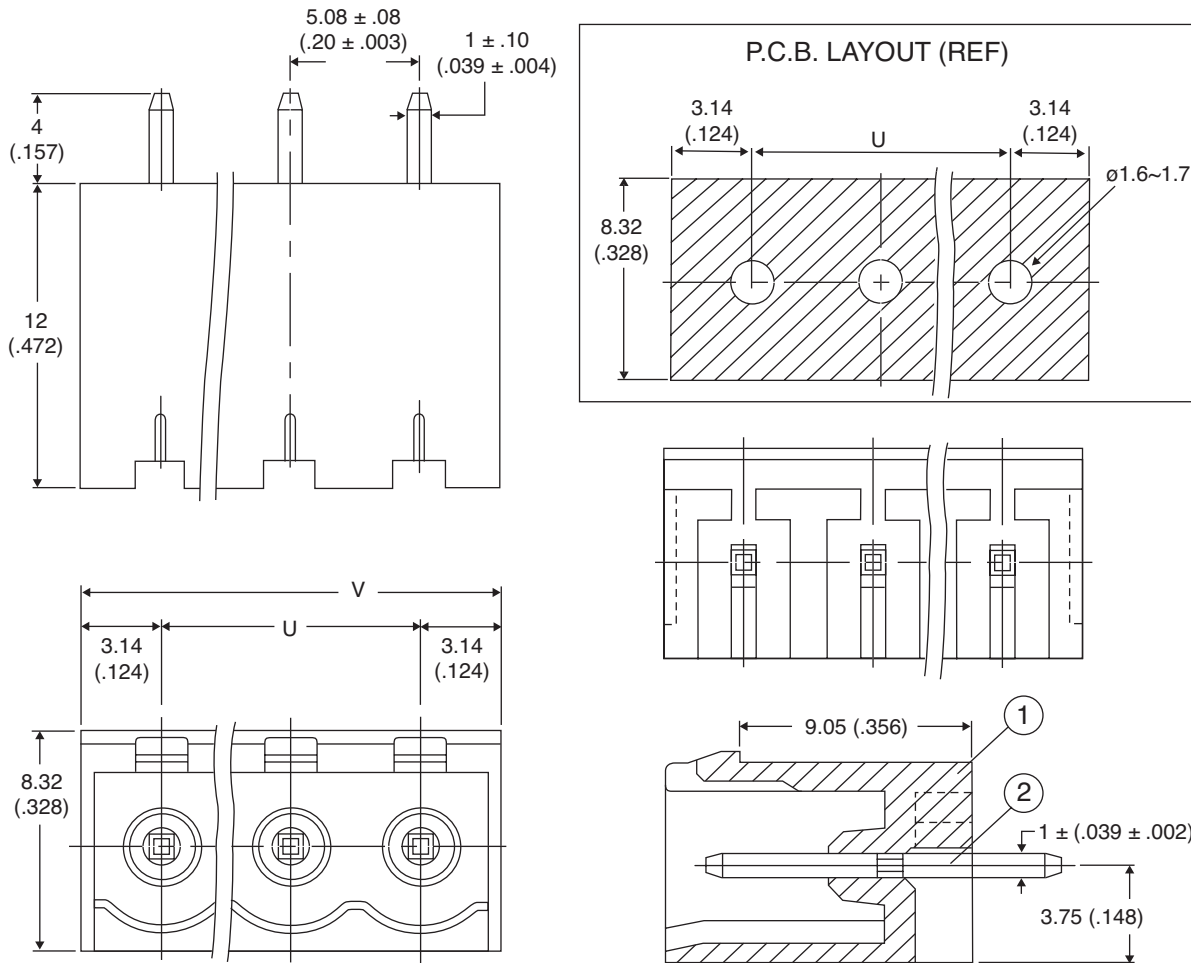

Terminal Block Headers



Dimensions: mm (In.)

P	02P	03P	04P	05P	06P	07P	08P	09P	10P	11P	12P
U mm	5.08	10.16	15.24	20.32	25.40	30.48	35.55	40.64	45.72	50.80	55.88
V mm	11.38	16.44	21.52	26.6	31.68	36.76	41.84	46.92	52.0	57.08	52.16

SPECIFICATIONS	
Rating:	300V 15A
Pitch:	5.08 mm
Insulation withstands voltage:	AC 1500 V/min
Insulation resistance:	500M Ω or more at DC500V
Temperature range:	-40°C ~ +105°C

MATERIAL SPECIFICATIONS	
2 Solder pin:	Copper tin plated
1 Housing:	PA66 green
RoHS Compliant	

Date Last Revised: 4/3/07

Available from Mouser Electronics
 1-800-346-6873
www.mouser.com

KC- 301129

Specifications are subject to change without notice. No liability or warranty implied by this information. Environmental compliance based on producer documentation.

158-P022EHDVCH-E, 158-P032EHDVCH-E, 158-P042EHDVCH-E, 158-P052EHDVCH-E,
 158-P062EHDVCH-E, 158-P072EHDVCH-E, 158-P082EHDVCH-E, 158-P092EHDVCH-E,
 158-P102EHDVCH-E, 158-P112EHDVCH-E, 158-P122EHDVCH-E