



Parameter	Rating	Units
Blocking Voltage	250	V_P
Load Current	50	mA_{rms} / mA_{DC}
On-Resistance (max)	100	Ω

Features

- Fast Switching Times: 0.125ms
- Low Off-State Leakage Current: 25nA
- 3750V_{rms} Input/Output Isolation
- 100% Solid State
- Low Drive Power Requirements (TTL/CMOS Compatible)
- Arc-Free With No Snubbing Circuits
- FCC Compatible
- VDE Compatible
- No EMI/RFI Generation
- Small 6-Pin Package
- Machine Insertable, Wave Solderable
- Tape & Reel Version Available

Applications

- Telecommunications
 - Telecom Switching
 - Tip/Ring Circuits
 - Modem Switching (Laptop, Notebook, Pocket Size)
 - Hook Switch
 - Dial Pulsing
 - Ground Start
 - Ringing Injection
- Instrumentation
 - Multiplexers
 - Data Acquisition
 - Electronic Switching
 - I/O Subsystems
- Meters (Watt-Hour, Water, Gas)
- Medical Equipment - Patient/Equipment Isolation
- Security
- Aerospace
- Industrial Controls

Description

OMA160 is a 250V, 50mA, 100 Ω , normally open (1-Form-A) relay. This high performance, optically isolated Solid State Relay provides one of the fastest (0.125ms) switching times available along with a very low off-state leakage current of 25nA.

Approvals

- UL Recognized Component: File E76270
- CSA Certified Component: Certificate # 1175739
- EN/IEC 60950-1 Certified Component: TUV Certificate B 09 07 49410 004

Ordering Information

Part Number	Description
OMA160	6-Pin DIP (50/Tube)
OMA160S	6-Pin Surface Mount (50/Tube)
OMA160STR	6-Pin Surface Mount (1000/Reel)

Pin Configuration

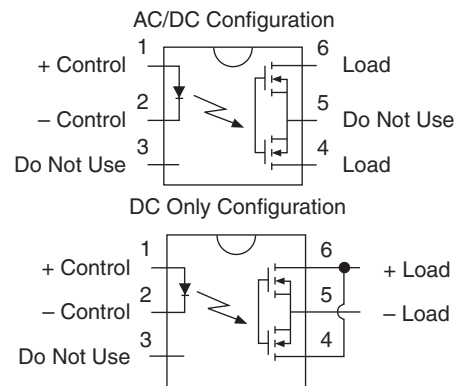

Switching Characteristics of Normally Open Devices

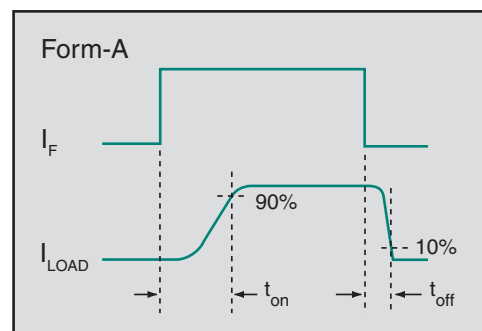

Absolute Maximum Ratings @ 25°C

Parameter	Ratings	Units
Blocking Voltage	250	V _P
Reverse Input Voltage	5	V
Input Control Current Peak (10ms)	50	mA
	1	A
Input Power Dissipation ¹	150	mW
Total Power Dissipation ²	800	mW
Isolation Voltage, Input to Output	3750	V _{rms}
Operational Temperature	-40 to +85	°C
Storage Temperature	-40 to +125	°C

Absolute Maximum Ratings are stress ratings. Stresses in excess of these ratings can cause permanent damage to the device. Functional operation of the device at conditions beyond those indicated in the operational sections of this data sheet is not implied.

¹ Derate linearly 1.33 mW / °C

² Derate linearly 6.67 mW / °C

Electrical Characteristics @ 25°C

Parameter	Conditions	Symbol	Min	Typ	Max	Units
Output Characteristics						
Load Current, Continuous AC/DC Configuration DC Configuration Peak	-	I _L	-	-	50	mA _{rms} / mA _{DC}
	-	I _{LPK}	-	-	80	mA _{DC}
	t=10ms	I _{LPK}	-	-	±100	mA _P
On-Resistance AC/DC Configuration DC Configuration	I _L =50mA	R _{ON}	-	50	100	Ω
	I _L =80mA			15	30	
Off-State Leakage Current	V _L =250V _P	I _{LEAK}	-	-	25	nA
Switching Speeds Turn-On Turn-Off	I _F =10mA, V _L =10V	t _{on}	-	-	0.125	ms
		t _{off}				
Output Capacitance	V _L =50V, f=1MHz	C _{OUT}	-	5	-	pF
Input Characteristics						
Input Control Current to Activate	I _L =50mA	I _F	-	-	10	mA
Input Control Current to Deactivate	-	I _F	0.4	-	-	mA
Input Voltage Drop	I _F =10mA	V _F	0.9	1.2	1.4	V
Reverse Input Current	V _R =5V	I _R	-	-	10	μA
Common Characteristics						
Input to Output Capacitance	-	C _{IO}	-	3	-	pF

PERFORMANCE DATA @25°C (Unless Otherwise Noted)*

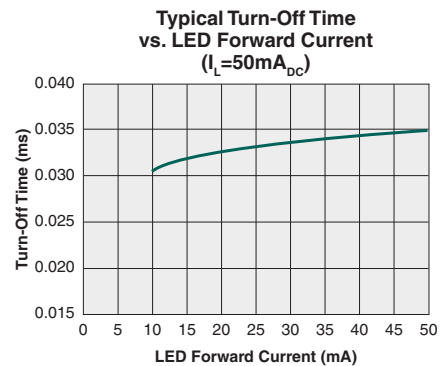
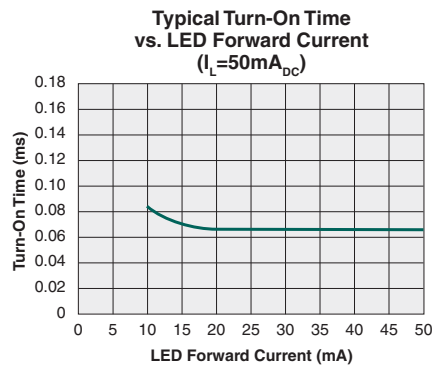
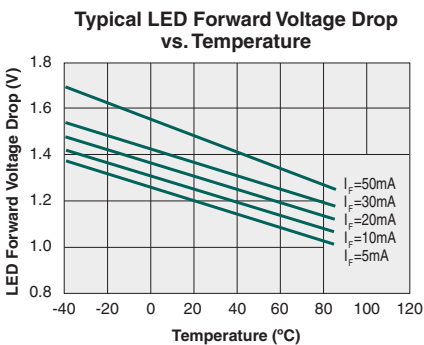
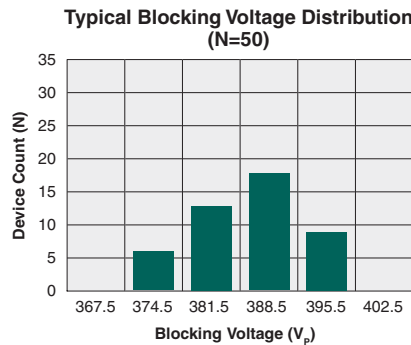
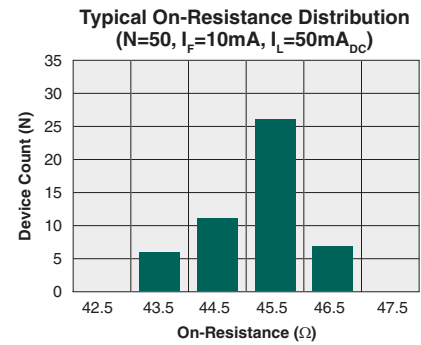
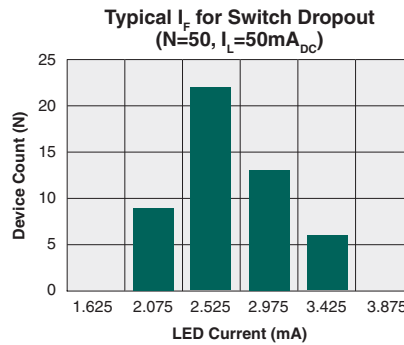
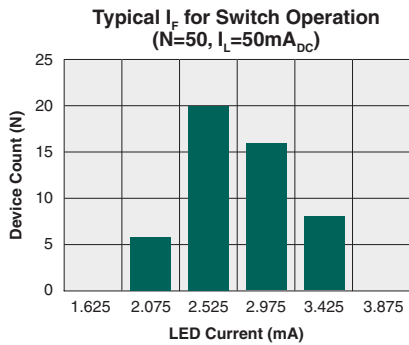
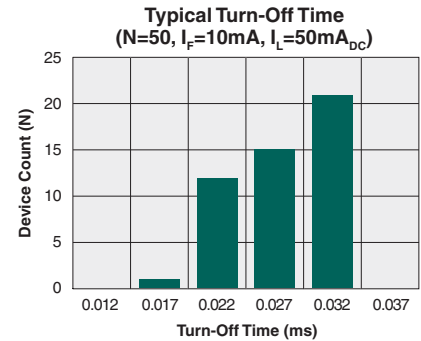
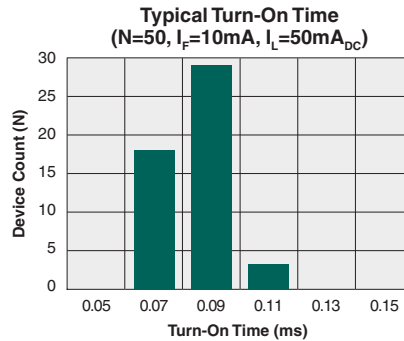
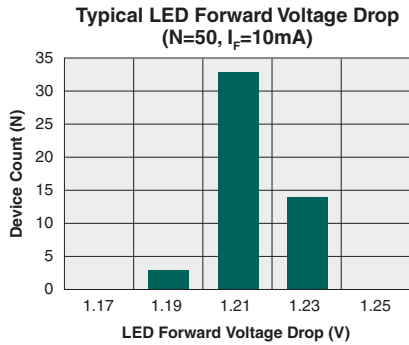

*The Performance data shown in the graphs above is typical of device performance. For guaranteed parameters not indicated in the written specifications, please contact our application department.

PERFORMANCE DATA @25°C (Unless Otherwise Noted)*

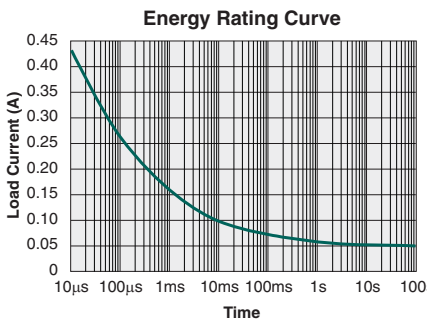
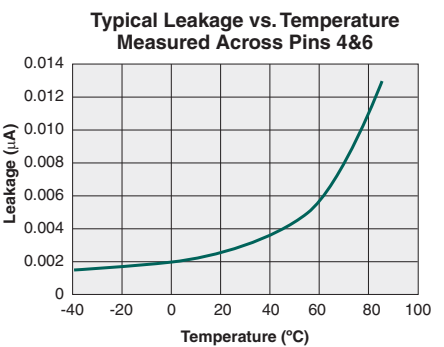
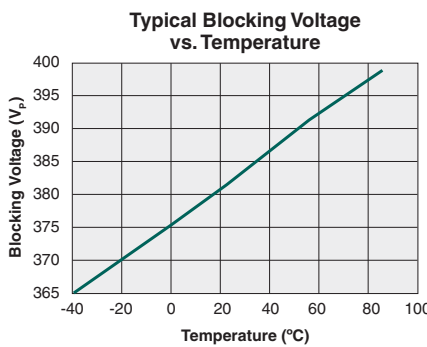
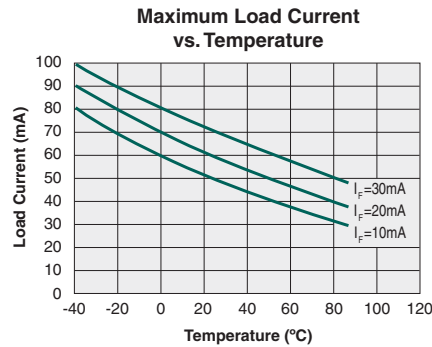
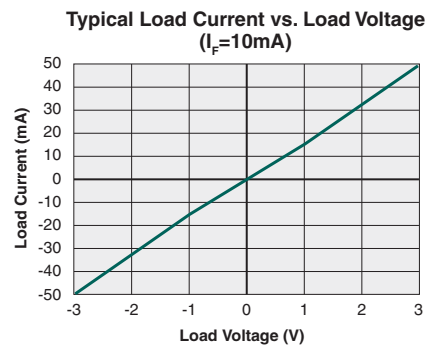
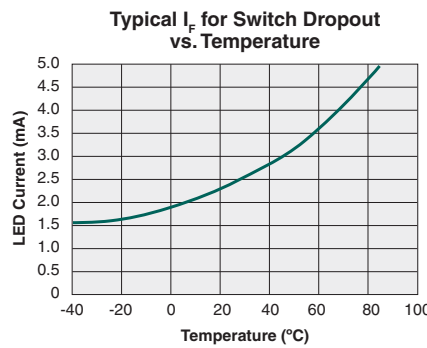
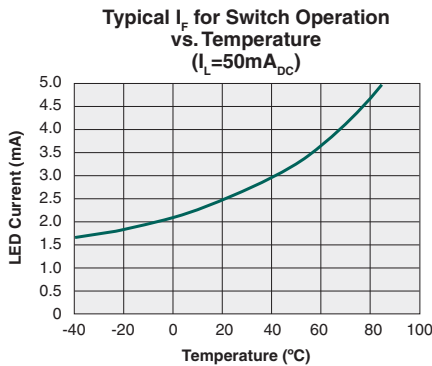
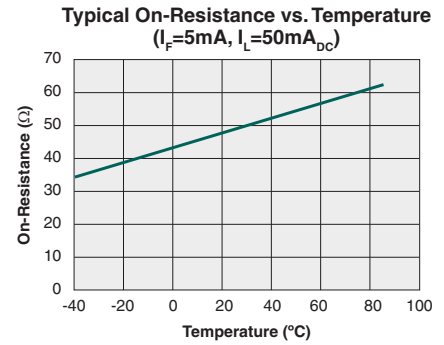
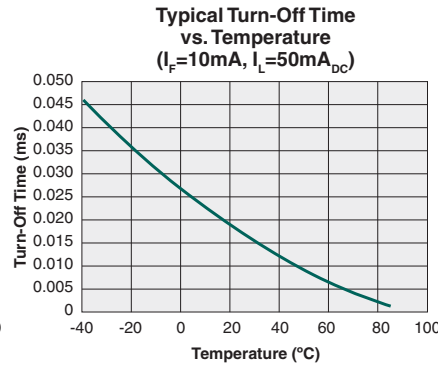
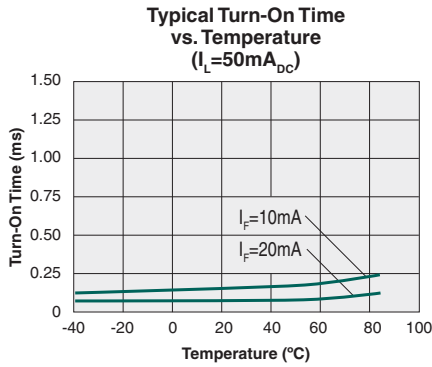

*The Performance data shown in the graphs above is typical of device performance. For guaranteed parameters not indicated in the written specifications, please contact our application department.

Manufacturing Information

Moisture Sensitivity



All plastic encapsulated semiconductor packages are susceptible to moisture ingress. IXYS Integrated Circuits Division classified all of its plastic encapsulated devices for moisture sensitivity according to the latest version of the joint industry standard, **IPC/JEDEC J-STD-020**, in force at the time of product evaluation. We test all of our products to the maximum conditions set forth in the standard, and guarantee proper operation of our devices when handled according to the limitations and information in that standard as well as to any limitations set forth in the information or standards referenced below.

Failure to adhere to the warnings or limitations as established by the listed specifications could result in reduced product performance, reduction of operable life, and/or reduction of overall reliability.

This product carries a **Moisture Sensitivity Level (MSL) rating** as shown below, and should be handled according to the requirements of the latest version of the joint industry standard **IPC/JEDEC J-STD-033**.

Device	Moisture Sensitivity Level (MSL) Rating
OMA160 / OMA160S	MSL 1

ESD Sensitivity



This product is **ESD Sensitive**, and should be handled according to the industry standard **JESD-625**.

Reflow Profile

This product has a maximum body temperature and time rating as shown below. All other guidelines of **J-STD-020** must be observed.

Device	Maximum Temperature x Time
OMA160 / OMA160S	250°C for 30 seconds

Board Wash

IXYS Integrated Circuits Division recommends the use of no-clean flux formulations. However, board washing to remove flux residue is acceptable. Since IXYS Integrated Circuits Division employs the use of silicone coating as an optical waveguide in many of its optically isolated products, the use of a short drying bake could be necessary if a wash is used after solder reflow processes. Chlorine- or Fluorine-based solvents or fluxes should not be used. Cleaning methods that employ ultrasonic energy should not be used.



Mechanical Dimensions

OMA160

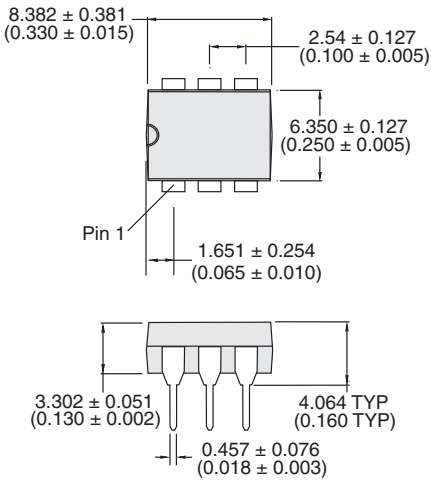

PCB Hole Pattern

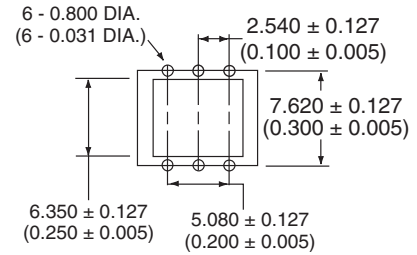

Dimensions
mm
(inches)

OMA160S

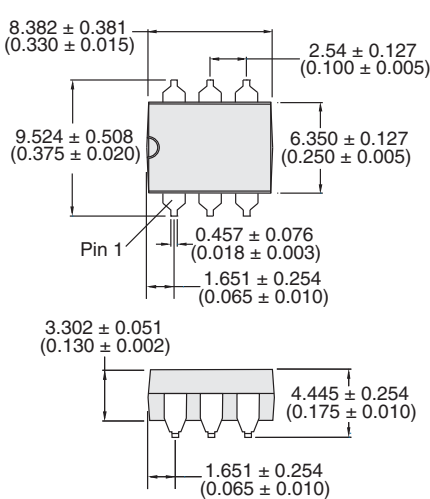

PCB Land Pattern

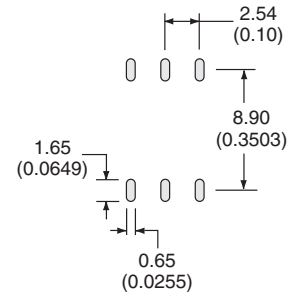

Dimensions
mm
(inches)

OMA160STR Tape & Reel

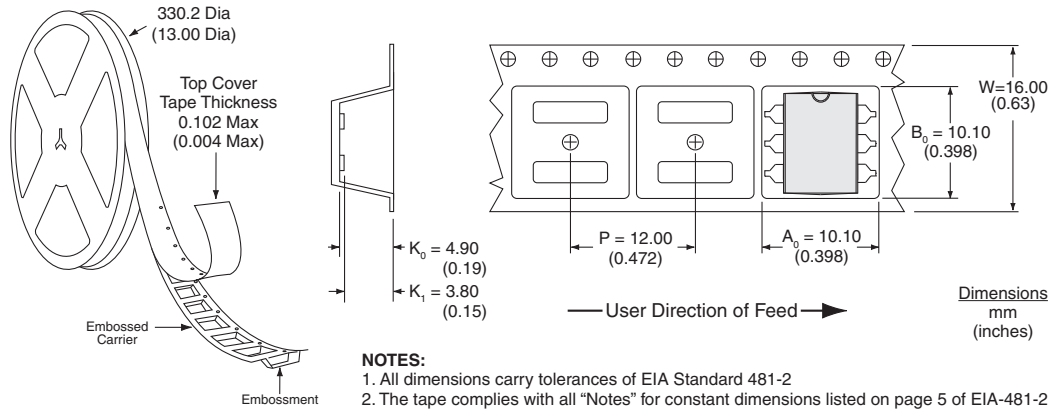

For additional information please visit our website at: www.ixysic.com

IXYS Integrated Circuits Division makes no representations or warranties with respect to the accuracy or completeness of the contents of this publication and reserves the right to make changes to specifications and product descriptions at any time without notice. Neither circuit patent licenses nor indemnity are expressed or implied. Except as set forth in IXYS Integrated Circuits Division's Standard Terms and Conditions of Sale, IXYS Integrated Circuits Division assumes no liability whatsoever, and disclaims any express or implied warranty, relating to its products including, but not limited to, the implied warranty of merchantability, fitness for a particular purpose, or infringement of any intellectual property right.

The products described in this document are not designed, intended, authorized or warranted for use as components in systems intended for surgical implant into the body, or in other applications intended to support or sustain life, or where malfunction of IXYS Integrated Circuits Division's product may result in direct physical harm, injury, or death to a person or severe property or environmental damage. IXYS Integrated Circuits Division reserves the right to discontinue or make changes to its products at any time without notice.