

ZB4BR4

red Ø60 mushroom pushbutton head Ø22
spring return



Main

| | |
|-------------------------------|-------------------------------------|
| Range of product | Harmony XB4 |
| Product or component type | Head for non-illuminated pushbutton |
| Device short name | ZB4 |
| Bezel material | Chromium plated metal |
| Mounting diameter | 22 mm |
| Sale per indivisible quantity | 1 |
| Shape of signaling unit head | Round |
| Type of operator | Spring return |
| Operator profile | Red mushroom Ø 60 mm unmarked |

Complementary

| | |
|------------------------------------|---------------------------|
| Resistance to high pressure washer | At 55 °C ,distance: 0.1 m |
| Mechanical durability | 5000000 cycles |

Environment

| | |
|--|--|
| Protective treatment | TH |
| Ambient air temperature for storage | -40...70 °C |
| Ambient air temperature for operation | -25...70 °C |
| Class of protection against electric shock | Class I conforming to IEC 60536 |
| IP degree of protection | IP66 conforming to IEC 60529 |
| NEMA degree of protection | NEMA 13 NEMA 4X |
| IK degree of protection | IK03 conforming to IEC 50102 |
| Standards | CSA C22-2 No 14 EN/IEC 60947-1 EN/IEC 60947-5-1 EN/IEC 60947-5-4 EN/IEC 60947-5-5 JIS C 4520 UL 508 |
| Product certifications | BV CSA DNV (Det Norske Veritas) GL LROS (Lloyds register of shipping) RINA UL listed |
| Vibration resistance | 5 gn (f = 2...500 Hz) conforming to IEC 60068-2-6 |
| Shock resistance | 30 gn for 18 ms half sine wave acceleration conforming to IEC 60068-2-27 50 gn for 11 ms half sine wave acceleration conforming to IEC 60068-2-27 |
| RoHS EUR conformity date | 0810 |
| RoHS EUR status | Compliant |

The information provided in this documentation contains general descriptions and/or technical characteristics of the performance of the products contained herein. This documentation is not intended as a substitute for and is not to be used for determining suitability or reliability of these products for specific user applications. It is the duty of any such user or integrator to perform the appropriate and complete risk analysis, evaluation and testing of the products with respect to the relevant specific application or use thereof. Neither Schneider Electric Industries SAS nor any of its affiliates or subsidiaries shall be responsible or liable for misuse of the information contained herein.

Dimensions of Heads for Spring Return Pushbuttons

Heads for Spring Return Pushbuttons

ZB4 BA•, ZB4 BA••

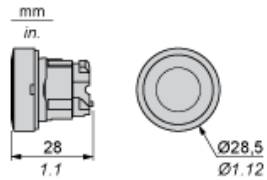

ZB4 BL•, ZB4 BL••

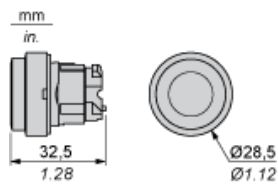

ZB4 BA•4, ZB4 BA•6

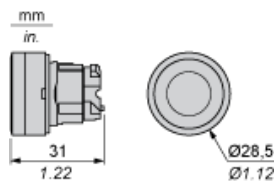

ZB4 BP••, ZB4 BP•S, ZB4 BP•83, ZB4 BP•

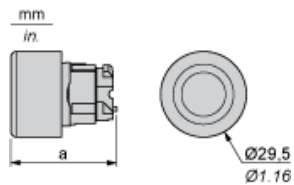

| | a in mm | a in in. |
|-----------|---------|----------|
| ZB4 BP•• | 36.5 | 1.44 |
| ZB4 BP•S | 33 | 1.30 |
| ZB4 BP•83 | 32 | 1.26 |
| ZB4 BP• | 35 | 1.38 |

Mushroom Heads for Spring Return Pushbuttons

ZB4 BC•4

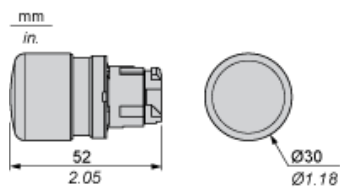

ZB4 BC•, ZB4 BR•

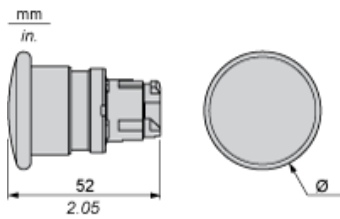

| | Ø in mm | Ø in in. |
|---------|---------|----------|
| ZB4 BC• | 40 | 1.57 |
| ZB4 BR• | 60 | 2.36 |

ZB4 BR•16

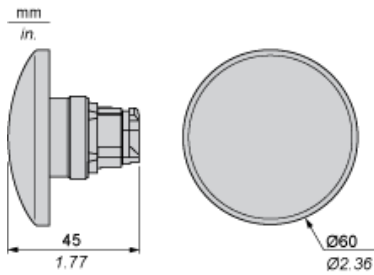

Heads for Double-Headed, Spring Return Pushbuttons

ZB4 BA712•, ZB4 BA734•, ZB4 BA79

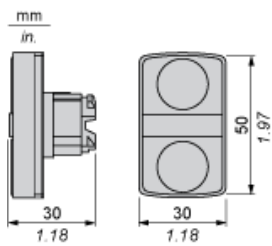

ZB4 BL734•

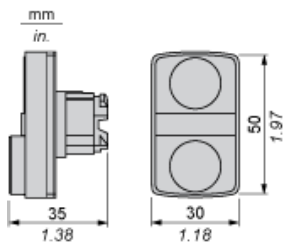

ZB4 BA712•, ZB4 BA734•, ZB4 BA79+ boot ZBA708

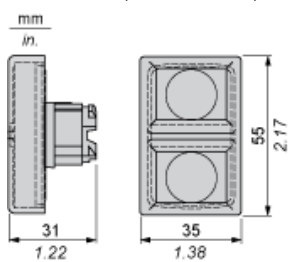

ZB4 BL734• + boot ZBA710

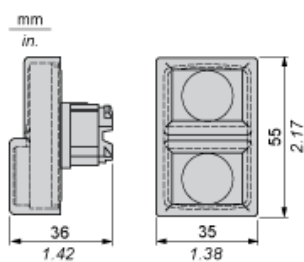

Heads for Triple-Headed, Spring Return Pushbuttons

ZB4 BA7313*, ZB4 BA711**, ZB4 BA72124, ZB4 BA791

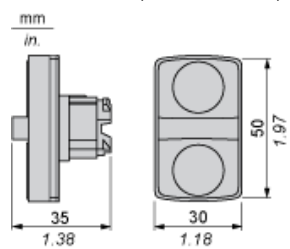

ZB4 BA7313*, ZB4 BA711**, ZB4 BA72124, ZB4 BA791 + boot ZBA709

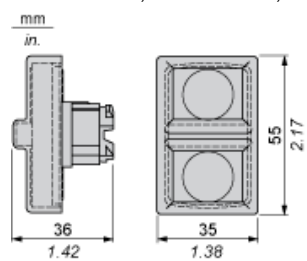

Panel Cut-out for Pushbuttons, Switches and Pilot Lights (Finished Holes, Ready for Installation)

| Connection by Screw Clamp Terminals or Plug-in Connectors or on Printed Circuit Board | Connection by Faston Connectors |
|--|---------------------------------|
| | |
| <p>(1) Diameter on finished panel or support (2) 40 mm min. / 1.57 in. min. (3) 30 mm min. / 1.18 in. min. (4) $\varnothing 22.5 \text{ mm}$ / 0.89 in. recommended ($\varnothing 22.3 \text{ mm}_0^{+0.4}$ / $0.88 \text{ in.}_0^{+0.016}$) (5) 45 mm min. / 1.78 in. min. (6) 32 mm min. / 1.26 in. min.</p> | |

Pushbuttons, Switches and Pilot Lights for Printed Circuit Board Connection

Panel Cut-outs (Viewed from Installer's Side)

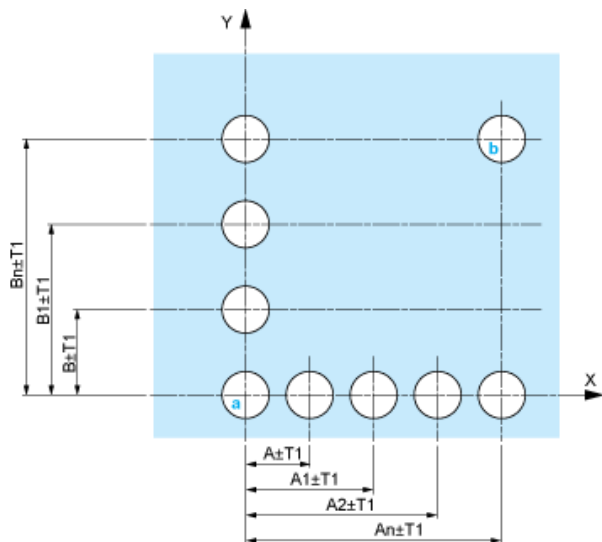

- A: 30 mm min. / 1.18 in. min.
 B: 40 mm min. / 1.57 in. min.

Printed Circuit Board Cut-outs (Viewed from Electrical Block Side)

Dimensions in mm

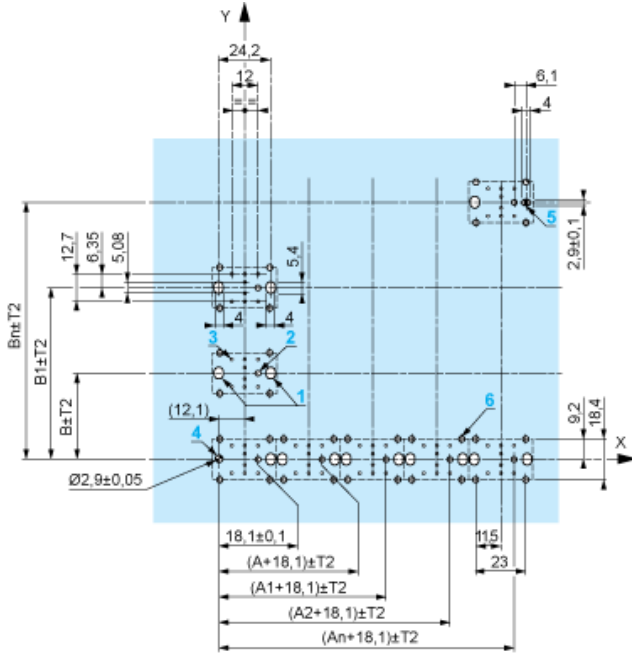

A: 30 mm min.

B: 40 mm min.

Dimensions in in.

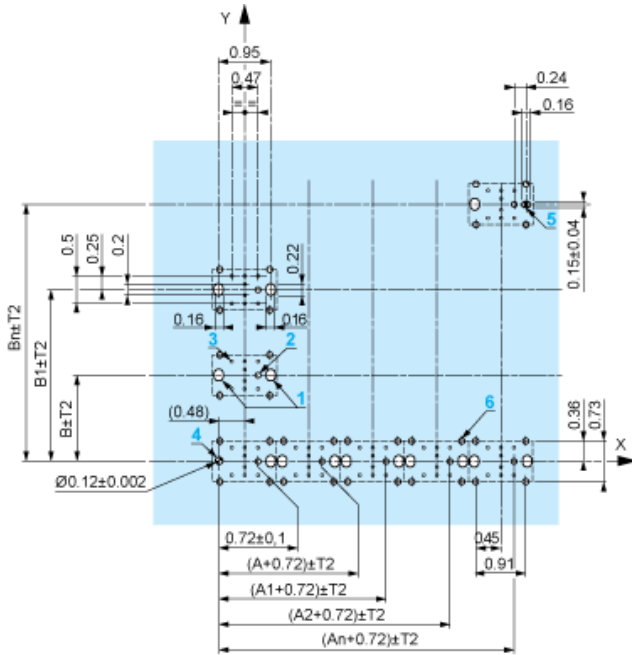

A: 1.18 in. min.

B: 1.57 in. min.

General Tolerances of the Panel and Printed Circuit Board

The cumulative tolerance must not exceed 0.3 mm / 0.012 in: $T1 + T2 = 0.3 \text{ mm max.}$

Installation Precautions

- Minimum thickness of circuit board: 1.6 mm / 0.06 in.
- Cut-out diameter: 22.4 mm \pm 0.1 / 0.88 in. \pm 0.004
- Orientation of body/fixing collar ZB4 BZ009: $\pm 2^\circ 30'$ (excluding cut-outs marked a and b).
- Tightening torque of screws ZBZ 006: 0.6 N.m. max.
- Allow for one ZB4 BZ079 fixing collar/pillar and its fixing screws:
 - every 90 mm / 3.54 in. horizontally (X), and 120 mm / 4.72 in. vertically (Y).
 - with each selector switch head (ZB4 BD•, ZB4 BJ•, ZB4 BG•).

The fixing centers marked a and b are diagonally opposed and must align with those marked 4 and 5.

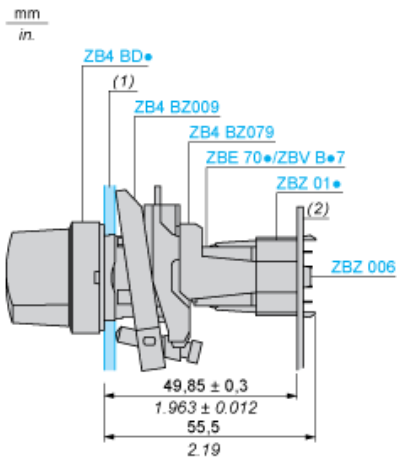

- (1) Panel
(2) Printed circuit board

Mounting of Adapter (Socket) ZBZ 01•

- 1 2 elongated holes for ZBZ 006 screw access
- 2 1 hole \varnothing 2.4 mm \pm 0.05 / 0.09 in. \pm 0.002 for centring adapter ZBZ 01•
- 3 8 \times \varnothing 1.2 mm / 0.05 in. holes
- 4 1 hole \varnothing 2.9 mm \pm 0.05 / 0.11 in. \pm 0.002, for aligning the printed circuit board (with cut-out marked a)
- 5 1 elongated hole for aligning the printed circuit board (with cut-out marked b)
- 6 4 holes \varnothing 2.4 mm / 0.09 in. for clipping in adapter ZBZ 01•

Dimensions An + 18.1 relate to the \varnothing 2.4 mm \pm 0.05 / 0.09 in. \pm 0.002 holes for centring adapter ZBZ 01•.