

FEATURES

- Qualified for automotive applications**
- High performance**
 - Temperature accuracy: $\pm 1^{\circ}\text{C}$ from -55°C to $+175^{\circ}\text{C}$ (2.7 V to 3.3 V)
 - 16-bit temperature resolution: 0.0078°C
 - Fast first temperature conversion on power-up of 6 ms
- Easy implementation**
 - No temperature calibration or correction required
 - No linearity correction required
- Low power**
 - Power-saving 1 sample per second (SPS) mode
 - 880 μW typical at 3.6 V in normal mode
 - 9 μW typical at 3.6 V in shutdown mode
- Wide operating ranges**
 - Temperature range: -55°C to $+175^{\circ}\text{C}$
 - Voltage range: 2.7 V to 5.5 V
- Programmable interrupts**
 - Critical overtemperature interrupt
 - Overtemperature/undertemperature interrupt
- SPI-compatible interface**
- Available in die form only**

APPLICATIONS

- Automotive
- High temperature monitoring
- High temperature thermal protection

GENERAL DESCRIPTION

The ADT7312 is a $\pm 1^{\circ}\text{C}$ accurate digital temperature sensor that operates over a very wide temperature range of -55°C to $+175^{\circ}\text{C}$ and is available in die form only. It contains an internal band gap reference, a temperature sensor, and a 16-bit analog-to-digital converter (ADC) to monitor and digitize the temperature to a resolution of 0.0078°C . The default ADC resolution is 13 bits (0.0625°C). The ADC resolution can be changed to 16 bits (0.0078°C) using the serial interface.

The ADT7312 is guaranteed to operate over supply voltages from 2.7 V to 5.5 V. At 3.6 V operation, the average supply current is typically 245 μA . The ADT7312 has a shutdown mode that powers down the device, resulting in a typical shutdown current of 2.5 μA at 3.6 V. The ADT7312 is rated for operation over the -55°C to $+175^{\circ}\text{C}$ temperature range.

The CT pin is an open-drain output that becomes active when the temperature exceeds a programmable critical temperature limit. The default critical temperature limit is 147°C . The INT pin is also an open-drain output that becomes active when the temperature exceeds a programmable limit. The INT pin and the CT pin can operate in either comparator or interrupt mode.

PRODUCT HIGHLIGHTS

1. Ease of use, no calibration or correction required.
2. Low power consumption.
3. Excellent long-term stability and reliability.
4. Qualified for automotive applications.

FUNCTIONAL BLOCK DIAGRAM

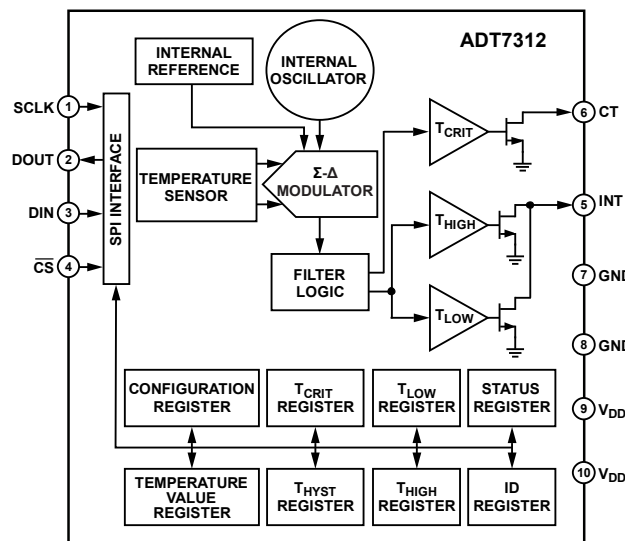

Figure 1.

Rev. A

Information furnished by Analog Devices is believed to be accurate and reliable. However, no responsibility is assumed by Analog Devices for its use, nor for any infringements of patents or other rights of third parties that may result from its use. Specifications subject to change without notice. No license is granted by implication or otherwise under any patent or patent rights of Analog Devices. Trademarks and registered trademarks are the property of their respective owners.

TABLE OF CONTENTS

Features	1	Temperature Value Register	15
Applications	1	ID Register	15
General Description	1	T _{CRIT} Setpoint Register	15
Product Highlights	1	T _{HYST} Setpoint Register	16
Functional Block Diagram	1	T _{HIGH} Setpoint Register	16
Revision History	2	T _{LOW} Setpoint Register	16
Specifications	3	Serial Interface	17
SPI Timing Specifications	4	SPI Command Byte	17
Absolute Maximum Ratings	5	Writing Data	18
ESD Caution	5	Reading Data	19
Pad Configuration and Function Descriptions	6	Interfacing to DSPs or Microcontrollers	19
Die Bond Pad Coordinates	7	Resetting the Serial Interface	19
Typical Performance Characteristics	8	INT and CT Outputs	20
Theory of Operation	9	Undertemperature and Overtemperature Detection	20
Circuit Description	9	Redundant Critical Generator	21
Converter Architecture	9	Applications Information	22
Normal Mode (Continuous Conversion Mode)	9	Thermal Response Time	22
One-Shot Mode	10	Supply Decoupling	22
1 SPS Mode	11	Powering from a Switching Regulator	22
Shutdown Mode	11	Temperature Monitoring	22
Fault Queue	11	Quick Guide to Measuring Temperature	22
Temperature Data Format	12	Outline Dimensions	23
Temperature Conversion Formulas	12	Ordering Guide	23
Registers	13	Automotive Products	23
Status Register	13		
Configuration Register	14		

REVISION HISTORY

6/12—Rev. 0 to Rev. A

Changed High Output Leakage Current, I _{OH} Maximum Parameter from 5 μ A to \pm 1 μ A	3
---	---

1/12—Revision 0: Initial Version

SPECIFICATIONS

$T_A = -55^\circ\text{C}$ to $+175^\circ\text{C}$, $V_{DD} = 2.7\text{ V}$ to 5.5 V , unless otherwise noted.

Table 1.

Parameter	Min	Typ	Max	Unit	Test Conditions/Comments
TEMPERATURE SENSOR AND ADC					
Accuracy ¹			± 1.0	$^\circ\text{C}$	$T_A = -55^\circ\text{C}$ to $+175^\circ\text{C}$, $V_{DD} = 2.7\text{ V}$ to 3.3 V
			± 1.1	$^\circ\text{C}$	$T_A = -55^\circ\text{C}$ to $+175^\circ\text{C}$, $V_{DD} = 3.3\text{ V}$ to 3.6 V
			± 1.2	$^\circ\text{C}$	$T_A = +150^\circ\text{C}$ to $+175^\circ\text{C}$, $V_{DD} = 4.5\text{ V}$ to 5.5 V
			± 1.5	$^\circ\text{C}$	$T_A = -55^\circ\text{C}$ to $+175^\circ\text{C}$, $V_{DD} = 4.5\text{ V}$ to 5.5 V
ADC Resolution		13		Bits	Twos complement temperature value of sign bit plus 12 bits (power-on default resolution)
		16		Bits	Twos complement temperature value of sign bit plus 15 bits (Bit 7 = 1 in the configuration register)
Temperature Resolution					
13-Bit		0.0625		$^\circ\text{C}$	13-bit resolution (sign bit plus 12 bits)
16-Bit		0.0078		$^\circ\text{C}$	16-bit resolution (sign bit plus 15 bits)
Temperature Conversion Time		240		ms	Continuous and one-shot conversion modes
Fast Temperature Conversion Time		6		ms	First conversion on power-up only
1 SPS Conversion Time		60		ms	1 SPS mode
Temperature Hysteresis		± 0.002		$^\circ\text{C}$	
Repeatability ²		± 0.015		$^\circ\text{C}$	$T_A = 25^\circ\text{C}$
DC PSRR		0.1		$^\circ\text{C}/\text{V}$	$T_A = 25^\circ\text{C}$
DIGITAL OUTPUTS (CT, INT)					
High Output Leakage Current, I_{OH}		+0.1	± 1	μA	Open-drain outputs
Output Low Voltage, V_{OL}			0.4	V	CT and INT pins pulled up to 5.5 V
Output High Voltage, V_{OH}	$0.7 \times V_{DD}$			V	$I_{OL} = 3\text{ mA}$ at 5.5 V , $I_{OL} = 1\text{ mA}$ at 3.3 V
Output Capacitance, C_{OUT}		2		pF	
DIGITAL INPUTS (DIN, SCLK, $\overline{\text{CS}}$)					
Input Current, I_{IN}			± 1	μA	$V_{IN} = 0\text{ V}$ to V_{DD}
Input Low Voltage, V_{IL}			0.4	V	
Input High Voltage, V_{IH}	$0.7 \times V_{DD}$			V	
Pin Capacitance, C_{IN}		5	10	pF	
DIGITAL OUTPUT (DOUT)					
Output High Voltage, V_{OH}	$V_{DD} - 0.3$			V	$I_{SOURCE} = I_{SINK} = 200\ \mu\text{A}$
Output Low Voltage, V_{OL}			0.4	V	$I_{OL} = 200\ \mu\text{A}$
Output Capacitance, C_{OUT}			50	pF	
POWER REQUIREMENTS					
Supply Voltage	2.7		5.5	V	
Supply Current					Peak current while converting; SPI interface inactive
Continuous Conversion Mode		245	320	μA	$V_{DD} = 3.6\text{ V}$
		275	350	μA	$V_{DD} = 5.5\text{ V}$
1 SPS Mode		55		μA	$V_{DD} = 3.6\text{ V}$, $T_A = 25^\circ\text{C}$
		70		μA	$V_{DD} = 5.5\text{ V}$, $T_A = 25^\circ\text{C}$
Shutdown Mode		2.5	40	μA	$V_{DD} = 3.6\text{ V}$
		5.4	50	μA	$V_{DD} = 5.5\text{ V}$
Power Dissipation					Power dissipated for $V_{DD} = 3.6\text{ V}$, $T_A = 25^\circ\text{C}$
Continuous Conversion Mode		880		μW	
1 SPS Mode		200		μW	
Shutdown Mode		9		μW	

¹ Accuracy includes lifetime drift.

² Based on a floating average of 10 readings.

SPI TIMING SPECIFICATIONS

$T_A = -55^{\circ}\text{C}$ to $+175^{\circ}\text{C}$, $V_{DD} = 2.7\text{ V}$ to 5.5 V , unless otherwise noted. All input signals are specified with rise time (t_R) = fall time (t_F) = 5 ns (10% to 90% of V_{DD}) and timed from a voltage level of 1.6 V .

Table 2.

Parameter ^{1, 2}	Limit at T_{MIN} , T_{MAX}	Unit	Description
t_1	0	ns min	\overline{CS} falling edge to SCLK active edge setup time
t_2	100	ns min	SCLK high pulse width
t_3	100	ns min	SCLK low pulse width
t_4	30	ns min	Data setup time prior to SCLK rising edge
t_5	25	ns min	Data hold time after SCLK rising edge
t_6	5	ns min	Data access time after SCLK falling edge
t_7^3	60	ns max	$V_{DD} = 4.5\text{ V}$ to 5.5 V
	80	ns max	$V_{DD} = 2.7\text{ V}$ to 3.6 V
t_8	10	ns min	Bus relinquish time after \overline{CS} inactive edge
	80	ns max	
t_9	0	ns min	SCLK inactive edge to \overline{CS} rising edge hold time
	0	ns min	\overline{CS} falling edge to DOUT active time
t_{10}	60	ns max	$V_{DD} = 4.5\text{ V}$ to 5.5 V
	80	ns max	$V_{DD} = 2.7\text{ V}$ to 3.6 V
t_{10}	10	ns min	SCLK inactive edge to DOUT low

¹ Sample tested during initial release to ensure compliance.

² See Figure 2.

³ The t_7 values are the true bus relinquish times of the part and, as such, are independent of external bus loading capacitances.

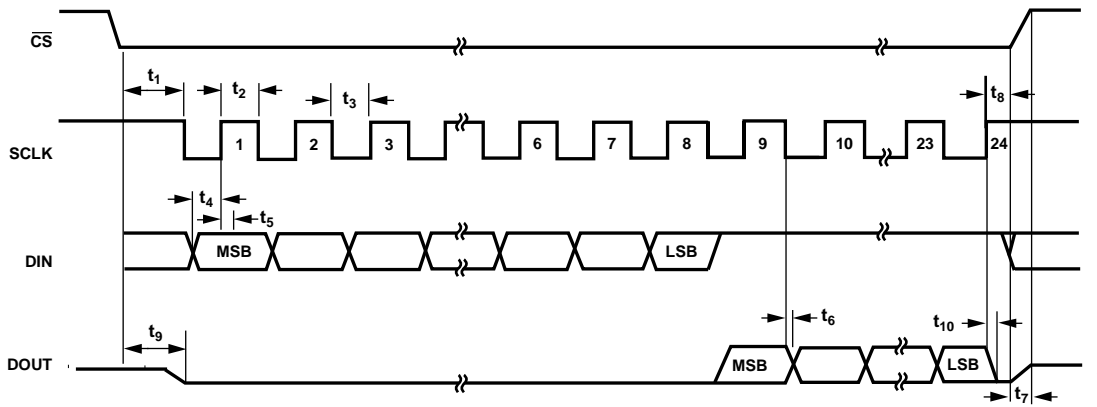

Figure 2. Detailed SPI Timing Diagram

06791-1-002

ABSOLUTE MAXIMUM RATINGS

Table 3.

Parameter	Rating
V _{DD} to GND	−0.3 V to +7 V
DIN Input Voltage to GND	−0.3 V to V _{DD} + 0.3 V
DOUT Output Voltage to GND	−0.3 V to V _{DD} + 0.3 V
SCLK Input Voltage to GND	−0.3 V to V _{DD} + 0.3 V
$\overline{\text{CS}}$ Input Voltage to GND	−0.3 V to V _{DD} + 0.3 V
CT and INT Output Voltage to GND	−0.3 V to V _{DD} + 0.3 V
ESD Rating (Human Body Model)	2.0 kV
Operating Temperature Range	−55°C to +175°C
Storage Temperature Range	−65°C to +175°C
Maximum Junction Temperature, T _{JMAX}	175°C

Stresses above those listed under Absolute Maximum Ratings may cause permanent damage to the device. This is a stress rating only; functional operation of the device at these or any other conditions above those indicated in the operational section of this specification is not implied. Exposure to absolute maximum rating conditions for extended periods may affect device reliability.

ESD CAUTION



ESD (electrostatic discharge) sensitive device. Charged devices and circuit boards can discharge without detection. Although this product features patented or proprietary protection circuitry, damage may occur on devices subjected to high energy ESD. Therefore, proper ESD precautions should be taken to avoid performance degradation or loss of functionality.

PAD CONFIGURATION AND FUNCTION DESCRIPTIONS

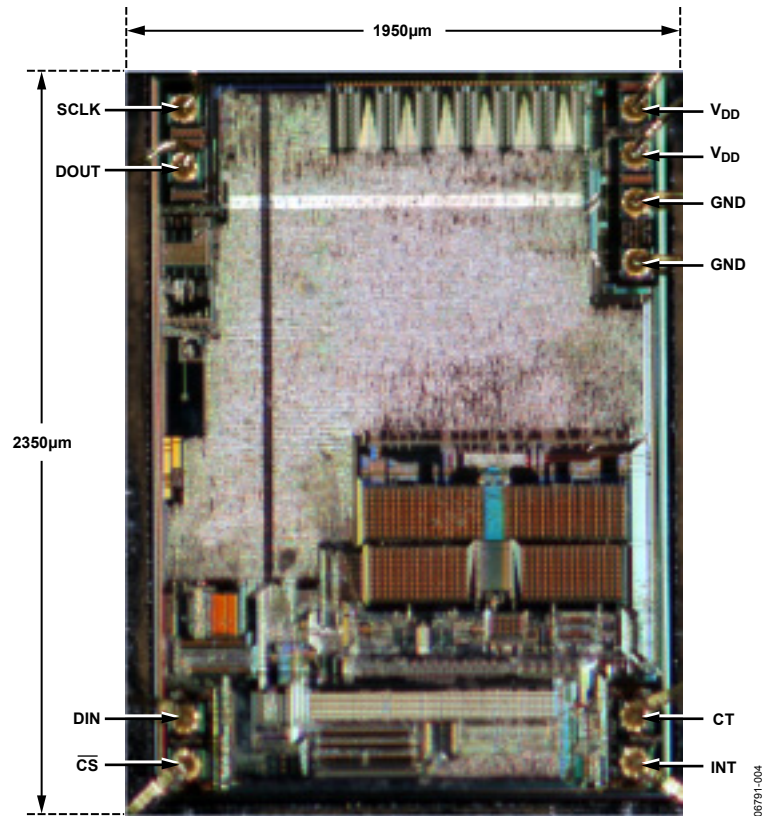

Figure 3. Metallization Picture

Table 4. Pad Function Descriptions

Pad No.	Pad Name	Description
1	SCLK	Serial Clock Input. The serial clock is used to clock data into and out of any register of the device.
2	DOUT	Serial Data Output. Data is clocked out on the falling edge of SCLK and is valid on the rising edge of SCLK.
3	DIN	Serial Data Input. Data to be loaded into the control registers of the part is provided on this input. Data is clocked into the registers on the rising edge of SCLK.
4	\overline{CS}	Chip Select Input. The device is enabled when this pin is low. The device is disabled when this pin is high.
5	INT	Overtemperature and Undertemperature Indicator. Logic output. When the device is powered up, this output is an active low interrupt by default. Open-drain configuration. A pull-up resistor is required, typically 10 k Ω .
6	CT	Critical Overtemperature Indicator. Logic output. The default power-on polarity is active low. Open-drain configuration. A pull-up resistor is required, typically 10 k Ω .
7	GND	Analog Ground. This pad must be connected directly to Pad 8 (digital ground).
8	GND	Digital Ground. This pad must be connected directly to Pad 7 (analog ground).
9	V _{DD}	Analog Supply Voltage (2.7 V to 5.5 V). This pad must be connected directly to Pad 10 (digital supply voltage). The supply should be decoupled with a 0.1 μ F ceramic capacitor to GND.
10	V _{DD}	Digital Supply Voltage (2.7 V to 5.5 V). This pad must be connected directly to Pad 9 (analog supply voltage). The supply should be decoupled with a 0.1 μ F ceramic capacitor to GND.

DIE BOND PAD COORDINATES

The following X and Y coordinates refer to the center of the bond pad and are referenced from the center of the die.

Table 5. Bond Pad Coordinates

Pad No.	Pad Name	X Coordinate (μm)	Y Coordinate (μm)
1	SCLK	-838	+1020
2	DOUT	-838	+831
3	DIN	-838	-863
4	$\overline{\text{CS}}$	-838	-1011
5	INT	+838	-1011
6	CT	+838	-863
7	GND	+838	+508
8	GND	+838	+702
9	V _{DD}	+838	+857
10	V _{DD}	+838	+1008

TYPICAL PERFORMANCE CHARACTERISTICS

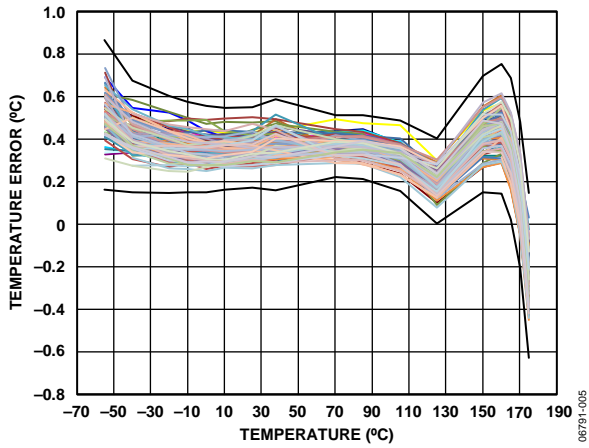

Figure 4. Temperature Accuracy at 3 V

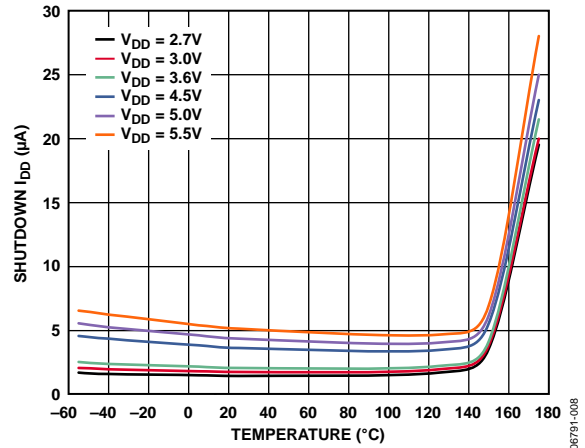

Figure 7. Shutdown Current vs. Temperature

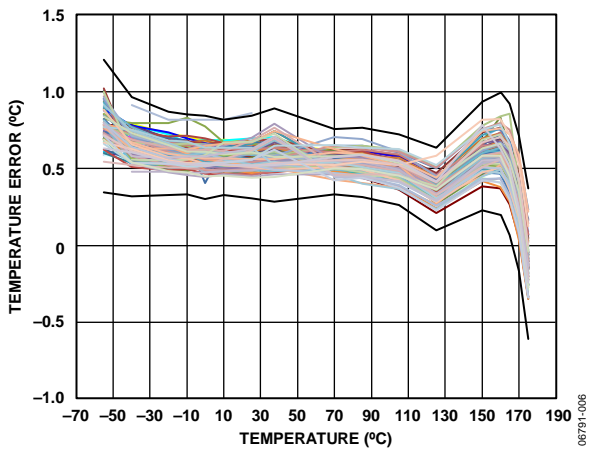

Figure 5. Temperature Accuracy at 5 V

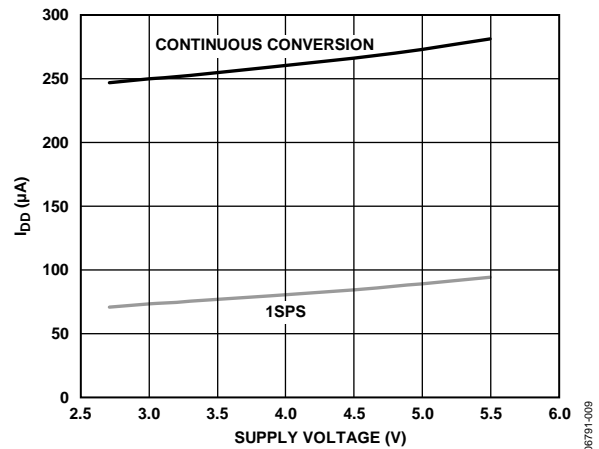

Figure 8. Operating Supply Current vs. Supply Voltage

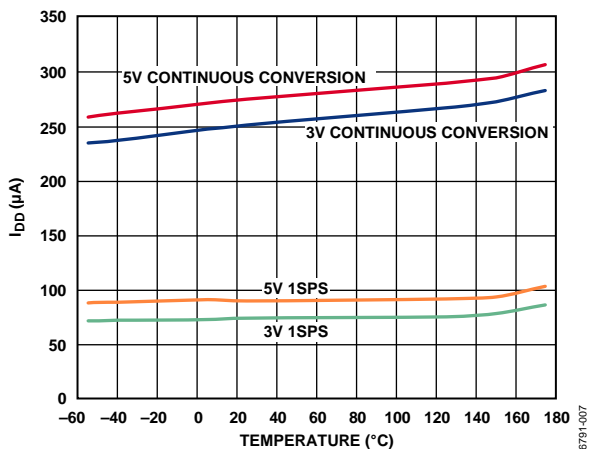

Figure 6. Operating Supply Current vs. Temperature

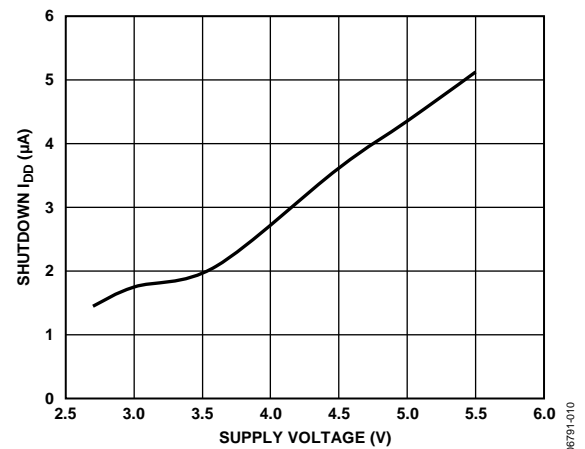

Figure 9. Shutdown Current vs. Supply Voltage

THEORY OF OPERATION

CIRCUIT DESCRIPTION

The ADT7312 is a $\pm 1^\circ\text{C}$ accurate digital temperature sensor that uses a 16-bit ADC to monitor and digitize the temperature to a resolution of 0.0078°C . By default, the ADC resolution is set to 13 bits (0.0625°C).

An internal temperature sensor generates a voltage proportional to absolute temperature; this voltage is compared to an internal voltage reference and input into a precision digital modulator. The internal temperature sensor has high accuracy and linearity over the entire rated temperature range without the need for correction or calibration by the user.

The sensor output is digitized by a sigma-delta (Σ - Δ) modulator, also known as a charge balance type ADC. This type of converter uses time domain oversampling and a high accuracy comparator to deliver 16 bits of resolution in an extremely compact circuit.

CONVERTER ARCHITECTURE

The Σ - Δ modulator consists of an input sampler, a summing network, an integrator, a comparator, and a 1-bit digital-to-analog converter (DAC). This architecture creates a negative feedback loop and minimizes the integrator output by changing the duty cycle of the comparator output in response to input voltage changes. The comparator samples the output of the integrator at a much higher rate than the input sampling frequency. This oversampling spreads the quantization noise over a much wider band than that of the input signal, improving overall noise performance and increasing accuracy.

The modulated output of the comparator is encoded using a circuit technique that results in SPI temperature data.

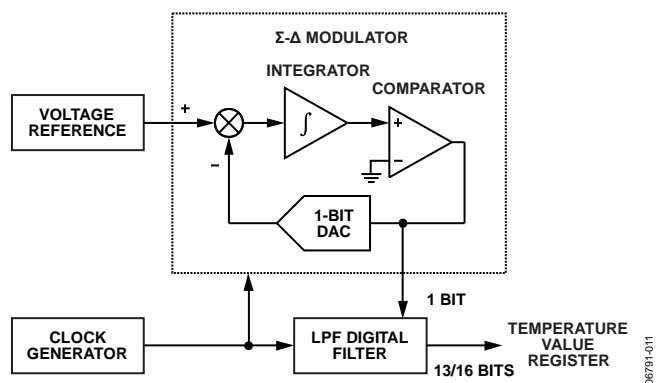

Figure 10. Σ - Δ Modulator

The ADT7312 can be configured to operate in any one of the following operating modes:

- Normal mode (continuous conversion mode)
- One-shot mode
- 1 SPS mode
- Shutdown mode

NORMAL MODE (CONTINUOUS CONVERSION MODE)

In normal mode (default power-on mode), the ADT7312 runs an automatic conversion sequence. During this automatic conversion sequence, a conversion typically takes 240 ms to complete. The ADT7312 is continuously converting; as soon as one temperature conversion is completed, another temperature conversion begins. Each temperature conversion result is stored in the temperature value register (Register Address 0x02) and is available through the SPI interface. In continuous conversion mode, the read operation provides the most recent converted result.

On power-up, the first conversion is a fast conversion, taking typically 6 ms. If the temperature exceeds 147°C , the CT pin is asserted low. If the temperature exceeds 64°C , the INT pin is asserted low. Fast conversion temperature accuracy is typically within $\pm 5^\circ\text{C}$.

The conversion clock for the part is generated internally. No external clock is required except when reading from and writing to the serial port.

The measured temperature value is compared with a critical temperature limit (stored in the 16-bit T_{CRIT} setpoint register), a high temperature limit (stored in the 16-bit T_{HIGH} setpoint register), and a low temperature limit (stored in the 16-bit T_{LOW} setpoint register). If the measured value exceeds the T_{HIGH} or T_{LOW} limit, the INT pin is activated; if the measured value exceeds the T_{CRIT} limit, the CT pin is activated. The polarity of the INT and CT pins is programmable using the configuration register (Register Address 0x01). The INT and CT pins are also programmable for interrupt mode via the configuration register.

ONE-SHOT MODE

When one-shot mode is enabled, the ADT7312 immediately completes a conversion and then goes into shutdown mode. The one-shot mode is useful when one of the circuit design priorities is to reduce power consumption.

To enable one-shot mode, set Bits[6:5] of the configuration register (Register Address 0x01) to 01. After writing to the operation mode bits (Bits[6:5]), wait at least 240 ms before reading back the temperature from the temperature value register (see Figure 11). This delay ensures that the ADT7312 has adequate time to power up and complete a conversion.

To obtain an updated temperature conversion, reset Bits[6:5] of the configuration register to 01.

CT and INT Operation in One-Shot Mode

Figure 12 illustrates the operation of the CT pin in one-shot mode when the T_{CRIT} overtemperature limit is exceeded. Note that in interrupt mode, a read from any register resets the CT and INT pins. (For more information about interrupt mode and comparator mode, see the Undertemperature and Overtemperature Detection section.)

If the INT pin is configured for comparator mode and the temperature falls below the $T_{HIGH} - T_{HYST}$ value or exceeds the $T_{LOW} + T_{HYST}$ value, a write to the operation mode bits of the configuration register (Register Address 0x01, Bits[6:5] = 01) resets the INT pin.

If the CT pin is configured for comparator mode and the temperature falls below the $T_{CRIT} - T_{HYST}$ value, a write to the operation mode bits of the configuration register (Register Address 0x01, Bits[6:5] = 01) resets the CT pin (see Figure 12).

When using one-shot mode, ensure that the refresh rate is appropriate to the application being used.

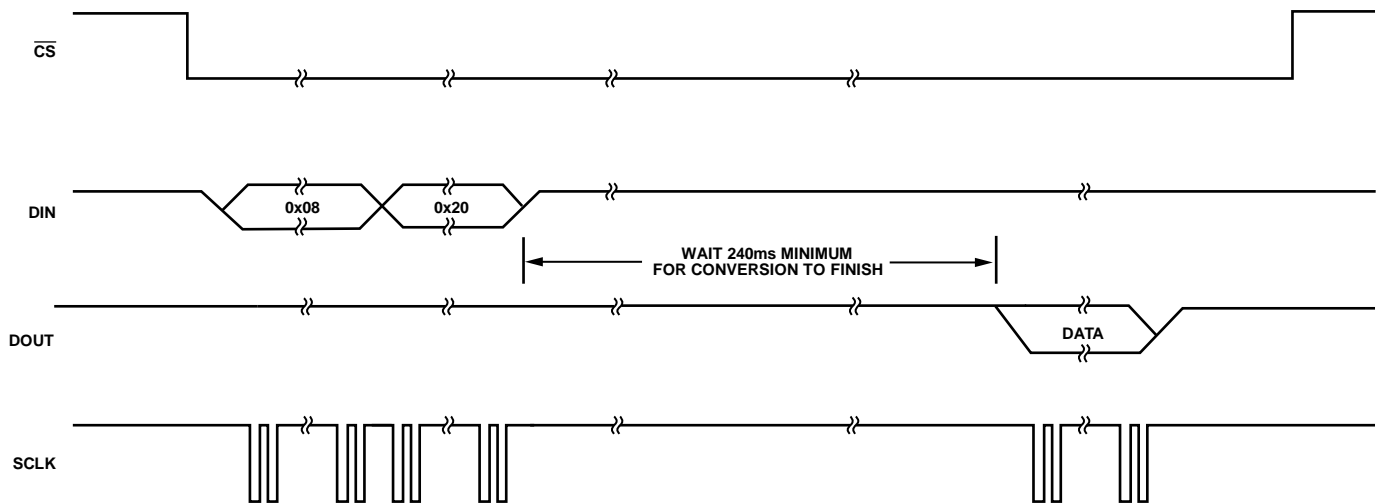

Figure 11. Typical SPI One-Shot Write to Configuration Register Followed by a Read from the Temperature Value Register

06791-012

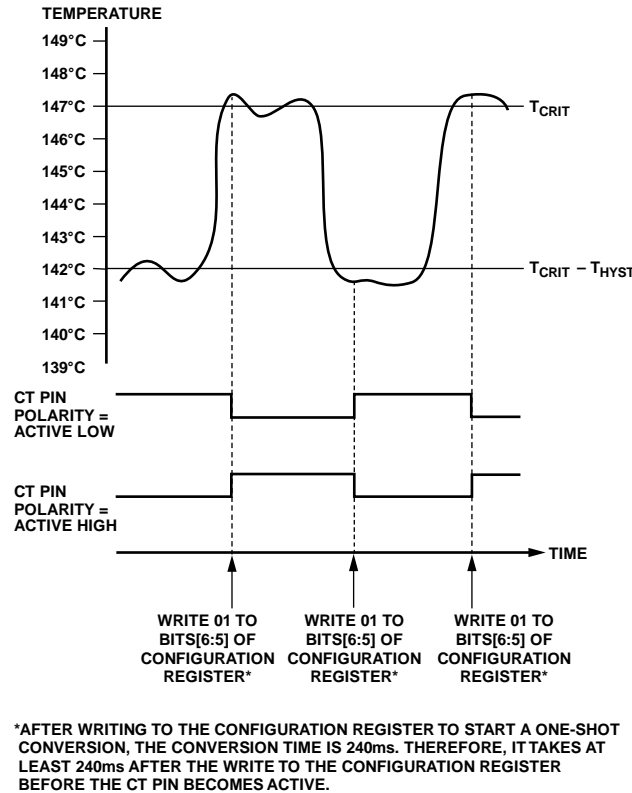

Figure 12. CT Pin Operation in One-Shot Mode

1 SPS MODE

In 1 SPS mode, the part performs one measurement per second. A conversion takes only 60 ms, and the part remains in the idle state for the remaining 940 ms period. To enable 1 SPS mode, set Bits[6:5] of the configuration register (Register Address 0x01) to 10.

SHUTDOWN MODE

The ADT7312 can be placed in shutdown mode by setting Bits[6:5] of the configuration register (Register Address 0x01) to 11. The ADT7312 can be taken out of shutdown mode by setting Bits[6:5] to 00 in the configuration register. The ADT7312 typically takes 1 ms (with a 0.1 μ F decoupling capacitor) to come out of shutdown mode. The conversion result from the last conversion prior to shutdown can still be read from the ADT7312 even when it is in shutdown mode.

When the part is taken out of shutdown mode, the internal clock is restarted and a conversion is initiated.

FAULT QUEUE

Bits[1:0] of the configuration register (Register Address 0x01) are used to configure the fault queue. Up to four faults are provided to prevent false tripping of the INT and CT pins when the ADT7312 is used in a noisy temperature environment. The number of faults set in the queue must occur consecutively to set the INT and CT outputs.

For example, if the fault queue is set to four, four consecutive temperature conversion results must exceed a temperature limit before the INT or CT pin is activated. If two consecutive temperature conversions exceed a temperature limit but the third conversion does not exceed a limit, the fault count is reset to zero.

TEMPERATURE DATA FORMAT

One LSB of the ADC corresponds to 0.0078°C in 16-bit mode. The ADC can theoretically measure a temperature range of 255°C, but the ADT7312 is guaranteed to measure a low value temperature limit of –55°C to a high value temperature limit of +175°C. The temperature measurement result is stored in the 16-bit temperature value register (Register Address 0x02). It is compared with the high temperature limits stored in the T_{CRIT} setpoint register and the T_{HIGH} setpoint register. The temperature measurement result is also compared with the low temperature limit stored in the T_{LOW} setpoint register.

Temperature data in the temperature value register, the T_{CRIT} setpoint register, the T_{HIGH} setpoint register, and the T_{LOW} setpoint register is represented by a 13-bit, twos complement word. The MSB is the temperature sign bit. When the part is powered up, the three LSBs, Bits[2:0], are not part of the temperature conversion result, but are flag bits for T_{CRIT}, T_{HIGH}, and T_{LOW}. Table 6 shows the 13-bit temperature data format without Bits[2:0].

Table 6. 13-Bit Temperature Data Format

Temperature	Digital Output (Bits[D15:D3])	
	Binary	Hex
–55°C	1 1100 1001 0000	0x1C90
–50°C	1 1100 1110 0000	0x1CE0
–25°C	1 1110 0111 0000	0x1E70
–0.0625°C	1 1111 1111 1111	0x1FFF
0°C	0 0000 0000 0000	0x0000
+0.0625°C	0 0000 0000 0001	0x0001
+25°C	0 0001 1001 0000	0x0190
+50°C	0 0011 0010 0000	0x0320
+125°C	0 0111 1101 0000	0x07D0
+150°C	0 1001 0110 0000	0x0960
+175°C	0 1010 1111 0000	0x0AF0

The number of bits in the temperature data-word can be extended to 16 bits, twos complement, by setting Bit 7 of the configuration register (Register Address 0x01) to 1. When using a 16-bit temperature data value, Bits[2:0] are the LSBs of the temperature value. The default power-on configuration is a 13-bit temperature data value.

Reading back the temperature from the temperature value register requires a 2-byte read. Designers who use a 9-bit temperature data format can still use the ADT7312 by ignoring the four LSBs of the 13-bit temperature value. These four LSBs are Bits[6:3] in Table 6.

TEMPERATURE CONVERSION FORMULAS

16-Bit Temperature Data Format

$$\text{Positive Temperature} = \text{ADC Code (dec)}/128$$

$$\text{Negative Temperature} = (\text{ADC Code (dec)} - 65,536)/128$$

where ADC Code uses all 16 bits of the data byte, including the sign bit.

$$\text{Negative Temperature} = (\text{ADC Code (dec)} - 32,768)/128$$

where the MSB is removed from the ADC code.

13-Bit Temperature Data Format

$$\text{Positive Temperature} = \text{ADC Code (dec)}/16$$

$$\text{Negative Temperature} = (\text{ADC Code (dec)} - 8192)/16$$

where ADC Code uses all 13 bits of the data byte, including the sign bit.

$$\text{Negative Temperature} = (\text{ADC Code (dec)} - 4096)/16$$

where the MSB is removed from the ADC code.

10-Bit Temperature Data Format

$$\text{Positive Temperature} = \text{ADC Code (dec)}/2$$

$$\text{Negative Temperature} = (\text{ADC Code (dec)} - 1024)/2$$

where ADC Code uses all 10 bits of the data byte, including the sign bit.

$$\text{Negative Temperature} = (\text{ADC Code (dec)} - 512)/2$$

where the MSB is removed from the ADC code.

9-Bit Temperature Data Format

$$\text{Positive Temperature} = \text{ADC Code (dec)}$$

$$\text{Negative Temperature} = \text{ADC Code (dec)} - 512$$

where ADC Code uses all nine bits of the data byte, including the sign bit.

$$\text{Negative Temperature} = \text{ADC Code (dec)} - 256$$

where the MSB is removed from the ADC code.

REGISTERS

The ADT7312 contains eight registers.

- Status register
- Configuration register
- Temperature value register
- ID register
- Four temperature setpoint registers

The status register, the temperature value register, and the ID register are read-only registers.

Table 7. ADT7312 Registers

Register Address	Register Name	Power-On Default
0x00	Status	0x80
0x01	Configuration	0x00
0x02	Temperature value	0x0000
0x03	ID	0xC3
0x04	T _{CRIT} setpoint	0x4980 (147°C)
0x05	T _{HYST} setpoint	0x05 (5°C)
0x06	T _{HIGH} setpoint	0x2000 (64°C)
0x07	T _{LOW} setpoint	0x0500 (10°C)

STATUS REGISTER

The 8-bit, read-only status register (Register Address 0x00) reflects the status of the overtemperature and undertemperature interrupts that can activate the CT and INT pins. This register also reflects the status of a temperature conversion operation.

The interrupt flags in the status register (Bits[6:4]) are reset by a read of the register or when the temperature value returns within the temperature limits (including hysteresis). The RDY bit (Bit 7) is reset to 1 after a read of the temperature value register (Register Address 0x02). In one-shot and 1 SPS modes, the RDY bit is reset after a write to the operation mode bits of the configuration register (Register Address 0x01, Bits[6:5]).

Table 8. Status Register (Register Address 0x00)

Bits	Default Value	Type	Name	Description
7	1	R	RDY	This bit is set to 0 when the temperature conversion result is written to the temperature value register. This bit is reset to 1 when the temperature value register is read. In one-shot and 1 SPS modes, this bit is reset after a write to the operation mode bits of the configuration register (Register Address 0x01, Bits[6:5]).
6	0	R	T _{CRIT}	This bit is set to 1 when the temperature exceeds the T _{CRIT} temperature limit. This bit is cleared to 0 when the status register is read or when the measured temperature falls below the limit (T _{CRIT} – T _{HYST}) set in the T _{CRIT} setpoint and T _{HYST} setpoint registers.
5	0	R	T _{HIGH}	This bit is set to 1 when the temperature exceeds the T _{HIGH} temperature limit. This bit is cleared to 0 when the status register is read or when the measured temperature falls below the limit (T _{HIGH} – T _{HYST}) set in the T _{HIGH} setpoint and T _{HYST} setpoint registers.
4	0	R	T _{LOW}	This bit is set to 1 when the temperature goes below the T _{LOW} temperature limit. This bit is cleared to 0 when the status register is read or when the measured temperature rises above the limit (T _{LOW} + T _{HYST}) set in the T _{LOW} setpoint and T _{HYST} registers.
[3:0]	0000	R	Unused	Reads back 0000.

CONFIGURATION REGISTER

The 8-bit, read/write configuration register (Register Address 0x01) stores configuration values for the [ADT7312](#). Configuration

values include the ADC resolution, the operational mode of the part, interrupt pin mode and polarity, and the depth of the fault queue for overtemperature and undertemperature events.

Table 9. Configuration Register (Register Address 0x01)

Bits	Default Value	Type	Name	Description
7	0	R/W	Resolution	This bit sets the resolution of the ADC when converting. 0 = 13-bit resolution (default). The sign bit plus 12 bits gives a temperature resolution of 0.0625°C. 1 = 16-bit resolution. The sign bit plus 15 bits gives a temperature resolution of 0.0078°C.
[6:5]	00	R/W	Operation mode	These two bits set the operational mode for the ADT7312 . 00 = continuous conversion mode (default). After one conversion is finished, the ADT7312 begins the next conversion. Conversion time is 240 ms typical. 01 = one-shot mode. Conversion time is 240 ms typical. 10 = 1 SPS mode. Conversion time is 60 ms typical. This operational mode reduces the average current consumption. 11 = shutdown mode. All circuitry except for the interface circuitry is powered down.
4	0	R/W	INT/CT mode	This bit selects comparator mode or interrupt mode. 0 = interrupt mode. 1 = comparator mode.
3	0	R/W	INT pin polarity	This bit selects the output polarity of the INT pin. 0 = active low. 1 = active high.
2	0	R/W	CT pin polarity	This bit selects the output polarity of the CT pin. 0 = active low. 1 = active high.
[1:0]	00	R/W	Fault queue	These two bits set the number of consecutive undertemperature or overtemperature faults that must occur before the INT and CT pins are activated. The fault queue helps to avoid false triggering due to temperature noise. 00 = 1 fault (default). 01 = 2 faults. 10 = 3 faults. 11 = 4 faults.

TEMPERATURE VALUE REGISTER

The 16-bit, read-only temperature value register (Register Address 0x02) stores the temperature measured by the internal temperature sensor. The temperature is stored as a 16-bit, twos complement value. The temperature is read back from the temperature value register as a 16-bit value.

When the ADC is configured to convert the temperature to a 13-bit digital value, Bits[2:0] are event alarm flags for T_{CRIT} , T_{HIGH} , and T_{LOW} . When the ADC is configured to convert the temperature to a 16-bit digital value, Bits[2:0] are the LSBs of the extended digital value. To configure the ADC for 13-bit or 16-bit resolution, write to Bit 7 of the configuration register (Register Address 0x01).

ID REGISTER

The 8-bit, read-only ID register (Register Address 0x03) stores the manufacturer ID in Bits[7:3] and the silicon revision in Bits[2:0].

T_{CRIT} SETPOINT REGISTER

The 16-bit, read/write T_{CRIT} setpoint register (Register Address 0x04) stores the critical overtemperature limit value. A critical overtemperature event occurs when the temperature value stored in the temperature value register exceeds the value stored in this register. The CT pin is activated if a critical overtemperature event occurs. The temperature is stored in twos complement format; the MSB is the temperature sign bit.

The default setting for the T_{CRIT} setpoint is +147°C.

Table 10. Temperature Value Register (Register Address 0x02)

Bits	Default Value	Type	Name	Description
15	0	R	Sign	Sign bit. Indicates whether the temperature value is negative or positive (0 = positive, 1 = negative).
[14:8]	0000000	R	Temp	Temperature value (Bits[14:8]) in twos complement format.
[7:3]	00000	R	Temp	Temperature value (Bits[7:3]) in twos complement format.
2	0	R	T_{CRIT} flag/LSB 2	If the part is configured for 13-bit resolution (Register Address 0x01, Bit 7 = 0), this bit flags a critical overtemperature event. When the temperature value exceeds T_{CRIT} , this bit is set to 1. If the part is configured for 16-bit resolution (Register Address 0x01, Bit 7 = 1), this bit is LSB 2 of the 15-bit temperature value.
1	0	R	T_{HIGH} flag/LSB 1	If the part is configured for 13-bit resolution (Register Address 0x01, Bit 7 = 0), this bit flags an overtemperature event. When the temperature value exceeds T_{HIGH} , this bit is set to 1. If the part is configured for 16-bit resolution (Register Address 0x01, Bit 7 = 1), this bit is LSB 1 of the 15-bit temperature value.
0	0	R	T_{LOW} flag/LSB 0	If the part is configured for 13-bit resolution (Register Address 0x01, Bit 7 = 0), this bit flags an undertemperature event. When the temperature value falls below T_{LOW} , this bit is set to 1. If the part is configured for 16-bit resolution (Register Address 0x01, Bit 7 = 1), this bit is LSB 0 of the 15-bit temperature value.

Table 11. ID Register (Register Address 0x03)

Bits	Default Value	Type	Name	Description
[7:3]	11000	R	Manufacturer ID	Contains the manufacturer identification number.
[2:0]	011	R	Revision ID	Contains the silicon revision identification number.

Table 12. T_{CRIT} Setpoint Register (Register Address 0x04)

Bits	Default Value	Type	Name	Description
[15:0]	0x4980	R/W	T_{CRIT}	16-bit critical overtemperature limit, stored in twos complement format. The default setting is +147°C.

T_{HYST} SETPOINT REGISTER

The 8-bit, read/write T_{HYST} setpoint register (Register Address 0x05) stores the temperature hysteresis value for the T_{HIGH}, T_{LOW}, and T_{CRIT} temperature limits. The temperature hysteresis value is stored in straight binary format using the four LSBs. Each LSB increments the hysteresis value in steps of 1°C from 0°C to 15°C. To implement hysteresis, the value in this register is subtracted from the T_{HIGH} and T_{CRIT} values and is added to the T_{LOW} value.

The default setting for the T_{HYST} setpoint is +5°C.

T_{HIGH} SETPOINT REGISTER

The 16-bit, read/write T_{HIGH} setpoint register (Register Address 0x06) stores the overtemperature limit value. An overtemperature event occurs when the temperature value stored in the temperature value register exceeds the value

stored in this register. The INT pin is activated if an over-temperature event occurs. The temperature is stored in twos complement format; the MSB is the temperature sign bit.

The default setting for the T_{HIGH} setpoint is +64°C.

T_{LOW} SETPOINT REGISTER

The 16-bit, read/write T_{LOW} setpoint register (Register Address 0x07) stores the undertemperature limit value. An undertemperature event occurs when the temperature value stored in the temperature value register is less than the value stored in this register. The INT pin is activated if an undertemperature event occurs. The temperature is stored in twos complement format; the MSB is the temperature sign bit.

The default setting for the T_{LOW} setpoint is +10°C.

Table 13. T_{HYST} Setpoint Register (Register Address 0x05)

Bits	Default Value	Type	Name	Description
[7:4]	0000	R/W	Unused	Not used.
[3:0]	0101	R/W	T _{HYST}	Hysteresis value, from 0°C to +15°C, stored in straight binary format. The default setting is +5°C.

Table 14. T_{HIGH} Setpoint Register (Register Address 0x06)

Bits	Default Value	Type	Name	Description
[15:0]	0x2000	R/W	T _{HIGH}	16-bit overtemperature limit, stored in twos complement format. The default setting is +64°C.

Table 15. T_{LOW} Setpoint Register (Register Address 0x07)

Bits	Default Value	Type	Name	Description
[15:0]	0x0500	R/W	T _{LOW}	16-bit undertemperature limit, stored in twos complement format. The default setting is +10°C.

SERIAL INTERFACE

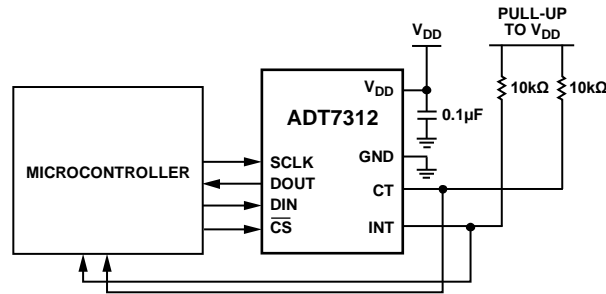

Figure 13. Typical SPI Interface Connection

The [ADT7312](#) has a 4-wire serial peripheral interface (SPI). The interface has a data input pin (DIN) for writing data to the device, a data output pin (DOUT) for reading data back from the device, and a data clock pin (SCLK) for clocking data into and out of the device. A chip select pin ($\overline{\text{CS}}$) enables or disables the [ADT7312](#). $\overline{\text{CS}}$ is required for correct operation of the serial interface. Data is clocked out of the [ADT7312](#) on the falling edge of SCLK; data is clocked into the device on the rising edge of SCLK.

SPI COMMAND BYTE

All data transactions on the bus begin with the master taking $\overline{\text{CS}}$ from high to low and sending out the command byte. The command byte indicates to the [ADT7312](#) whether the transaction is a read or a write and provides the address of the register for the data transfer. Table 16 shows the command byte.

Table 16. Command Byte

C7	C6	C5	C4	C3	C2	C1	C0
0	R/W	Register address			0	0	0

Bit C7, Bit C2, Bit C1, and Bit C0 of the command byte must all be set to 0 to successfully begin a bus transaction. The SPI interface does not work correctly if a 1 is written to any of these bits.

Bit C6 is the read/write bit: 1 indicates a read, and 0 indicates a write.

Bits[C5:C3] contain the target register address. One register can be read from or written to per bus transaction.

WRITING DATA

Data is written to the ADT7312 in 8 bits or 16 bits, depending on the addressed register. The first byte written to the device is the command byte, with the read/write bit set to 0. The master then supplies the 8-bit or 16-bit input data on the DIN line. The ADT7312 clocks the data into the register addressed in the command byte on the rising edge of SCLK. The master ends the write transaction by pulling CS high.

Figure 14 shows a write to an 8-bit register, and Figure 15 shows a write to a 16-bit register.

The master must begin a new write transaction on the bus, for every register write. Only one register is written to per bus transaction.

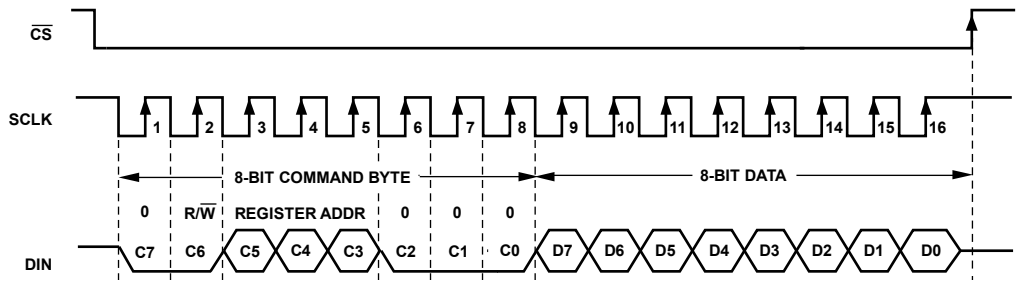

Figure 14. Writing to an 8-Bit Register

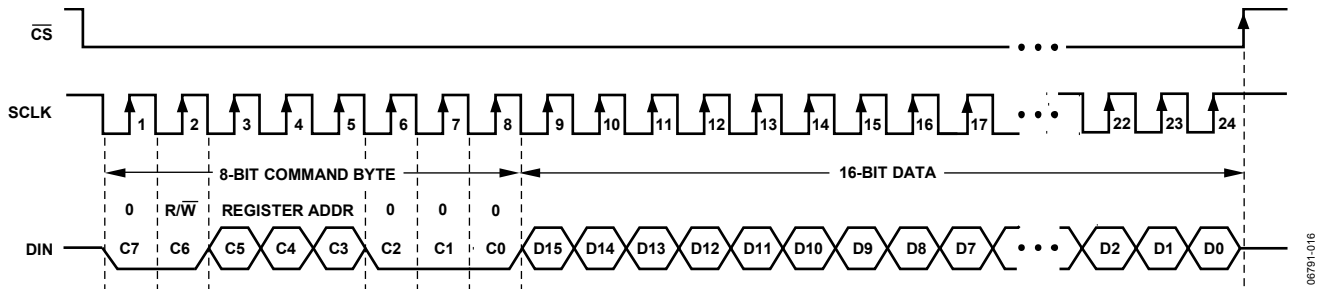

Figure 15. Writing to a 16-Bit Register

READING DATA

A read transaction begins when the master writes the command byte to the ADT7312 with the read/write bit set to 1. The master then supplies 8 or 16 clock pulses, depending on the addressed register, and the ADT7312 clocks data out of the addressed register on the DOUT line. Data is clocked out on the first falling edge of SCLK following the command byte. The master ends the read transaction by pulling CS high.

Figure 16 shows a read from an 8-bit register, and Figure 17 shows a read from a 16-bit register.

INTERFACING TO DSPs OR MICROCONTROLLERS

The ADT7312 can operate with CS used as a frame synchronization signal. This setup is useful for DSP interfaces. In this case, the first bit (MSB) is effectively clocked out by CS because CS normally occurs after the falling edge of SCLK in DSPs. SCLK can continue to run between data transfers, provided that the timing specifications in Table 2 are adhered to.

CS can be tied to ground, and the serial interface operated in a 3-wire mode. DIN, DOUT, and SCLK are used to communicate with the ADT7312 in this mode.

For microcontroller interfaces, it is recommended that SCLK idle high between data transfers.

RESETTING THE SERIAL INTERFACE

The serial interface can be reset by writing a series of 1s on the DIN input. If a Logic 1 is written to the ADT7312 DIN line for at least 32 serial clock cycles, the serial interface is reset. This ensures that the interface can be reset to a known state if the connection is lost due to a software error or a glitch in the system. A reset returns the serial interface to the state in which it waits for a write to one of the registers in the ADT7312. This operation resets the contents of all registers to their power-on default values. Following a reset, the user should allow a delay of 500 μs before addressing the serial interface.

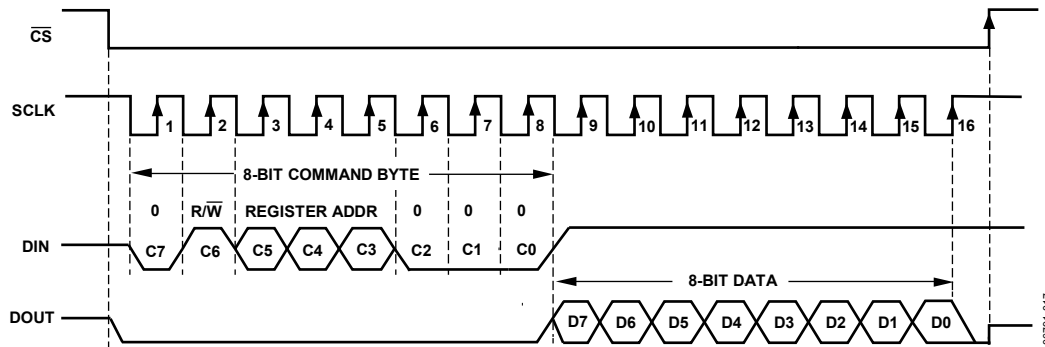

Figure 16. Reading from an 8-Bit Register

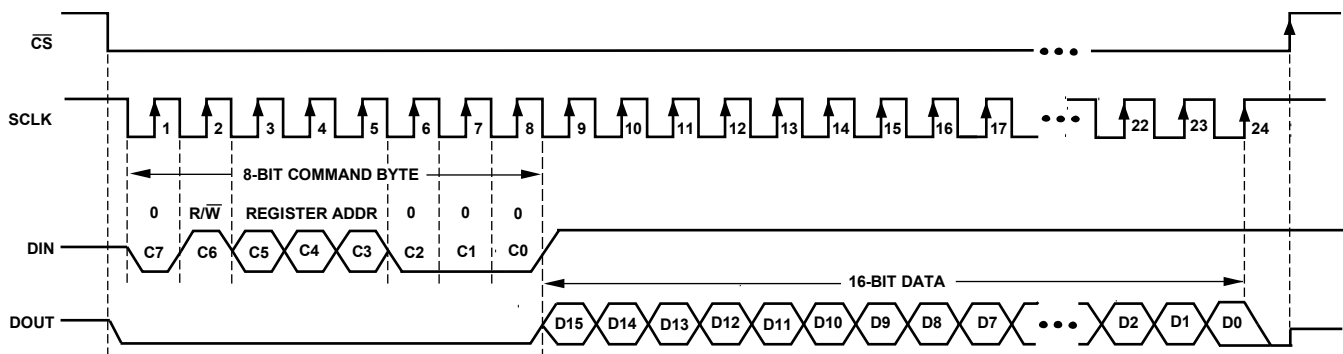

Figure 17. Reading from a 16-Bit Register

INT AND CT OUTPUTS

INT and CT are open-drain outputs. Both outputs require a 10 kΩ pull-up resistor to V_{DD}. The ADT7312 must be fully powered up to V_{DD} before it can read INT and CT data.

UNDERTEMPERATURE AND OVERTEMPERATURE DETECTION

The INT and CT pins have two undertemperature/overtemperature modes: comparator mode and interrupt mode. Interrupt mode is the default power-on mode. The INT output becomes active when the temperature is greater than the temperature stored in the T_{HIGH} setpoint register or less than the temperature stored in the T_{LOW} setpoint register. How the INT pin reacts after an overtemperature or undertemperature event depends on whether comparator mode or interrupt mode is selected.

Figure 18 illustrates the comparator and interrupt modes for events exceeding the T_{HIGH} limit with both pin polarity settings. Figure 19 illustrates the comparator and interrupt modes for events exceeding the T_{LOW} limit with both pin polarity settings.

Comparator Mode

In comparator mode, the INT output returns to its inactive state when the temperature falls below the T_{HIGH} - T_{HYST} limit or rises above the T_{LOW} + T_{HYST} limit.

Placing the ADT7312 into shutdown mode does not reset the INT state in comparator mode.

Interrupt Mode

In interrupt mode, the INT output returns to its inactive state when any ADT7312 register is read. When INT is reset, it becomes active again only when the temperature is greater than the temperature stored in the T_{HIGH} setpoint register or less than the temperature stored in the T_{LOW} setpoint register.

Placing the ADT7312 into shutdown mode resets the INT output in interrupt mode.

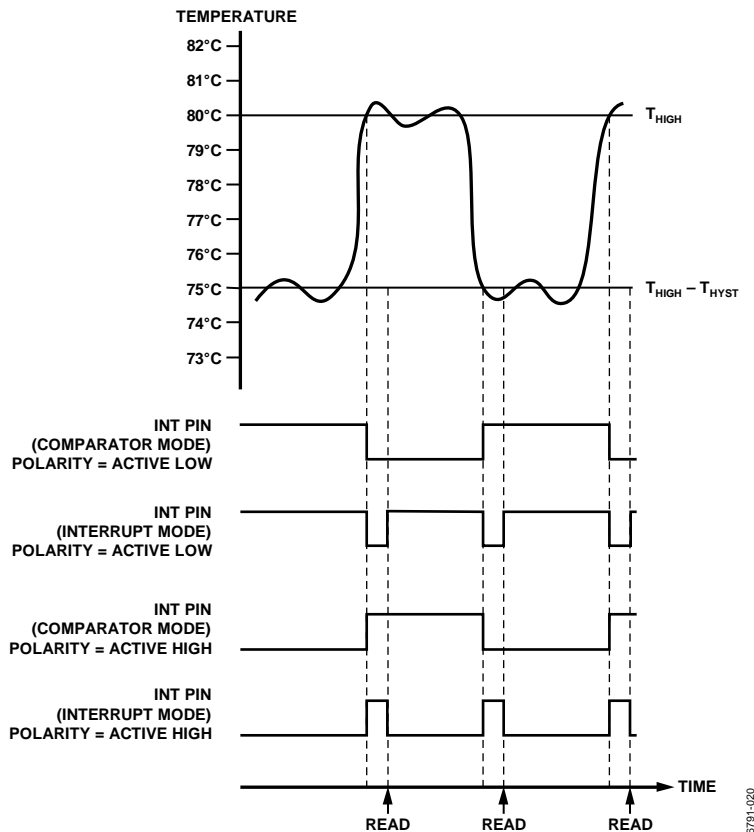

Figure 18. INT Output Response to T_{HIGH} Overtemperature Events

06791-020

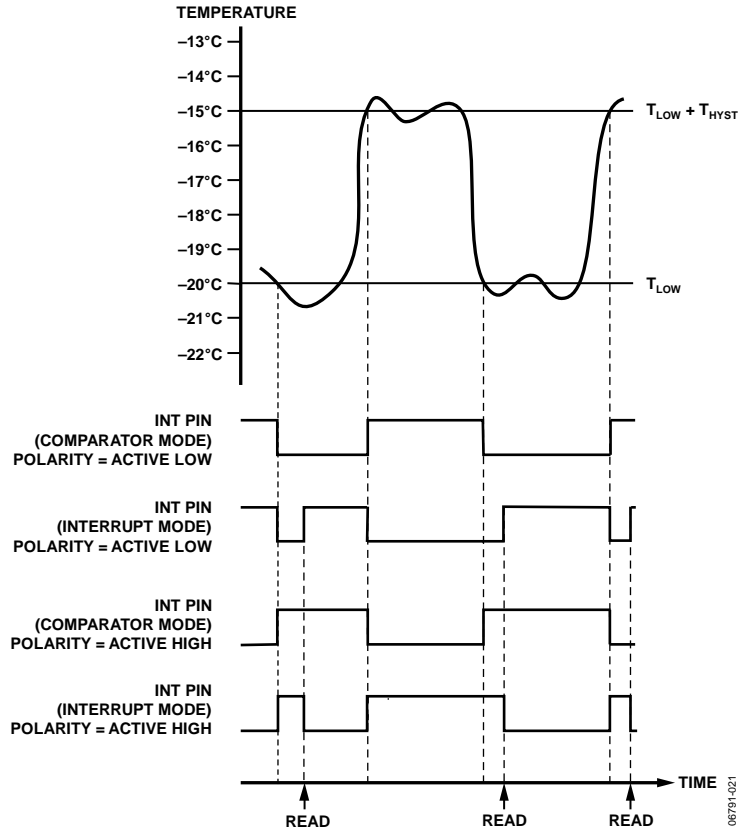

Figure 19. INT Output Response to T_{Low} Undertemperature Events

REDUNDANT CRITICAL GENERATOR

The CT output is normally activated when the actual temperature exceeds the value stored in the T_{CRIT} setpoint register (default value is $147^{\circ}C + T_{HYST}$). To prevent the CT output from being deactivated after the temperature exceeds $175^{\circ}C$, the ADT7312 incorporates a redundant standalone circuit (redundant critical generator) to specifically control the CT output at temperatures above $175^{\circ}C$.

This circuit incorporates hysteresis to ensure a safe working temperature. Figure 20 shows the redundant critical generator assuming control when the temperature reaches $180^{\circ}C$ by activating the CT output; this circuit does not deactivate the CT output until the temperature reaches $138^{\circ}C$. The redundant critical generator is programmed in production to ensure that all parts are triggered at the same temperatures ($180^{\circ}C$ and $138^{\circ}C$).

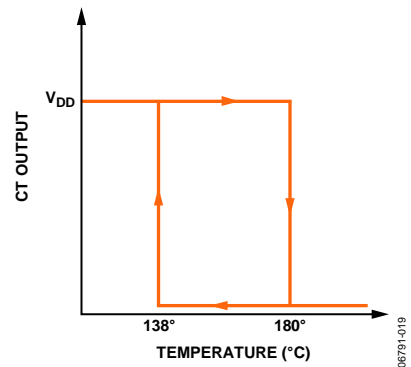

Figure 20. CT Output Response Using the Redundant Critical Generator

APPLICATIONS INFORMATION

THERMAL RESPONSE TIME

Thermal response is a function of the thermal mass of the temperature sensor, but it is also heavily influenced by the mass of the object that the IC is mounted to. For example, a large PCB containing large amounts of copper tracking can act as a large heat sink and slow the thermal response. For a faster thermal response, it is recommended that the sensor be mounted on a PCB that is as small as possible.

SUPPLY DECOUPLING

The ADT7312 must have a decoupling capacitor connected between V_{DD} and GND; otherwise, incorrect temperature readings are obtained. A 0.1 μF decoupling capacitor, such as a high frequency ceramic type, must be used and mounted as close as possible to the V_{DD} pads of the ADT7312.

If possible, the ADT7312 should be powered directly from the system power supply (see Figure 21). This arrangement isolates the analog section from the logic-switching transients. Even if a separate power supply trace is not available, generous supply bypassing reduces supply line induced errors. Local supply bypassing consisting of a 0.1 μF ceramic capacitor is critical for the temperature accuracy specifications to be achieved.

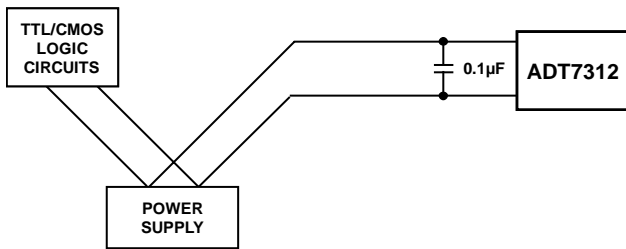

Figure 21. Use of Separate Traces to Reduce Power Supply Noise

POWERING FROM A SWITCHING REGULATOR

Precision analog devices such as the ADT7312 require a well-filtered power source. If the ADT7312 is powered from a switching regulator, noise can be generated above 50 kHz that may affect the temperature accuracy specifications. To prevent this, an RC filter should be used between the power supply and the ADT7312 V_{DD} pins. The value of the components used should be carefully considered to ensure that the peak value of the supply noise is less than 1 mV. The RC filter should be mounted as far away as possible from the ADT7312 to ensure that the thermal mass is kept as low as possible.

TEMPERATURE MONITORING

The ADT7312 is ideal for monitoring the thermal environment of high temperature automotive applications. The ADT7312 measures and converts the temperature at the surface of its own semiconductor chip.

When the ADT7312 is used to measure the temperature of a nearby heat source, the thermal impedance between the heat source and the ADT7312 must be considered. When the thermal impedance is determined, the temperature of the heat source can be inferred from the ADT7312 output. Most of the heat transferred from the heat source to the thermal sensor on the ADT7312 die is routed via the copper traces, the bond pads, and GND.

Therefore, to measure the temperature of a heat source, it is recommended that the thermal resistance between the GND pads of the ADT7312 and the GND of the heat source be reduced as much as possible.

QUICK GUIDE TO MEASURING TEMPERATURE

To measure temperature in continuous conversion mode (default power-on mode), follow these steps.

1. After power-up, reset the serial interface (load 32 consecutive 1s on DIN). This step ensures that all internal circuitry is correctly initialized.
2. Verify the setup by reading the device ID (Register Address 0x03). It should read 0xC3.
3. After consistent consecutive readings are obtained from the device ID register, read the following registers:
 - Configuration register (Register Address 0x01)
 - T_{CRIT} setpoint register (Register Address 0x04)
 - T_{HIGH} setpoint register (Register Address 0x06)
 - T_{LOW} setpoint register (Register Address 0x07)
4. Compare the values in these registers to the default values listed in Table 7. If all the readings match Table 7, the interface is operational.
5. Write to the configuration register (Register Address 0x01) to set the ADT7312 to the desired configuration. Read the temperature value register (Register Address 0x02). It should produce a valid temperature measurement.

OUTLINE DIMENSIONS

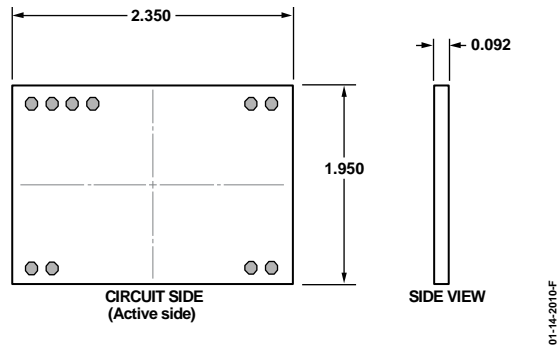

Figure 22. 10-Pad Bare Die [CHIP]
(C-10-1)
Dimensions shown in millimeters

ORDERING GUIDE

Model ^{1,2}	Temperature Range ³	Temperature Accuracy ⁴	Package Description	Package Option
ADT7312WCZ-PT7	-55°C to +175°C	±1.0°C	Die in Pocket Tape	C-10-1
EVAL-ADT7X10EBZ			Evaluation Board	

¹ Z = RoHS Compliant Part.

² W = Qualified for Automotive Applications.

³ Operating at extended temperatures over prolonged periods may shorten the lifetime performance of the part.

⁴ Maximum accuracy over the -55°C to +175°C temperature range ($V_{DD} = 2.7\text{ V to }3.3\text{ V}$).

AUTOMOTIVE PRODUCTS

The [ADT7312W](#) models are available with controlled manufacturing to support the quality and reliability requirements of automotive applications. Note that these automotive models may have specifications that differ from the commercial models; therefore, designers should review the Specifications section of this data sheet carefully. Only the automotive grade products shown are available for use in automotive applications. Contact your local Analog Devices account representative for specific product ordering information and to obtain the specific Automotive Reliability reports for these models.

NOTES