



Chip Protectors

For ESD protection

SGNE series

SGNE04

0402 [01005 inch]*

SGNE06

0603 [0201 inch]

* Dimensions Code JIS[EIA]

REMINDERS FOR USING THESE PRODUCTS

Before using these products, be sure to request the delivery specifications.

SAFETY REMINDERS

Please pay sufficient attention to the warnings for safe designing when using these products.

REMINDERS

- Please note the following precautions in order to avoid problems with chip protectors such as characteristic degradation and element destruction.
 - Please store these products in an environment with a temperature of 5 to 40°C and humidity level of 20 to 70%RH, and use them within six months.
 - Poor storage conditions may lead to the deterioration of the solderability of the terminal electrodes, so please be careful to avoid contact with humidity, dew condensation, dust, toxic gas (hydrogen, hydrogen sulfide, sulfurous acid, chlorine, ammonia, etc.), direct sunlight, and so on.
 - Please do not use products that have been dropped or detached when mounting.
 - Please solder with the reflow soldering method, and not the flow (dip) soldering method.
- Please note the following precautions to avoid problems with chip protectors such as characteristic degradation and element destruction, which ultimately lead to the generation of heat and smoke with the elements.
 - Do not use in locations where the temperatures exceed the operating temperature range such as under direct sunlight or near sources of heat.
 - Do not use in locations where there are high levels of humidity such as under direct exposure to weather and areas where steam is released.
 - Do not use in locations such as dusty areas, high-saline environments, places where the atmosphere is contaminated with corrosive gas, etc.
 - Avoid powerful vibrations, impact (such as by dropping), pressure, etc. that may lead to splitting in the products.
 - Do not use with a voltage that exceeds the maximum allowable circuit voltage.**
 - When resin coating (including modular) a varistor, do not use a resin that will cause deterioration of the varistor. Be sure never to use resin that generates hydrogen as palladium is used for the inner electrode.
 - Avoid attachment near combustible materials.
- Please contact our sales offices when considering the use of the products listed on this catalog for applications, whose performance and/or quality require a more stringent level of safety or reliability, or whose failure, malfunction or trouble could cause serious damage to society, person or property ('specific uses' such as automobiles, airplanes, medical instruments, nuclear devices, etc.) as well as when considering the use for applications that exceed the range and conditions of this catalog.
 - Please also contact us when using these products for automotive applications.
- Please note that we are not responsible for any damages or losses incurred resulting from the use of these products that exceeds the range and conditions of this catalog or specific uses.
- Please take appropriate measures such as acquiring protective circuits and devices that meet the uses, applications, and conditions of the instruments and keeping backup circuits.

Chip Protectors

Product compatible with RoHS directive
Compatible with lead-free solders

ESD Protection

Overview of the SGNE Series

FEATURES

- Multilayer chip protector is the ESD protection solution which is using a semiconductor ceramic.
- It is the possible replacement of TVS Diode for ESD protection.
- Chip size is available with EIA01005(0402mm), EIA0201(0603mm).
- Rather than the present products of TDK, it has the outstanding ESD absorption feature.
- Excellent ESD protection characteristic. (Based on IEC61000-4-2, Contact-8kV)

APPLICATION

- ESD protection such as signal line, audio line
- Filter for EMI protection
- Smart phone, tablet PC, portable music player, note PC, etc

PART NUMBER CONSTRUCTION

SGNE		04		C		080		M		T		150		N		25	
Series name	LxW Dimensions (mm)		Structure		Breakdown voltage (V)		Varistor voltage tolerance (%)		Packaging style		Capacitance (pF)		Capacitance tolerance* (%)		ESD Clamp voltage Average voltage (IEC61000-4-2, 8kV)		
	04	0.4x0.2			080	8	M	±20	T	Taping	150	15	N	±30			
	06	0.6x0.3			270	27					6R8	6.8	G	±2pF			

RoHS Directive Compliant Product: See the following for more details related to RoHS Directive compliant products. <http://product.tdk.com/en/environment/rohs/>

• All specifications are subject to change without notice.

Overview of the SGNE Series

TDK ESD Protection Device Map

Multilayer chip protector is a ESD protection component which has excellent ESD absorption characteristic and the low capacitance. This SGNE series is suitable for the applications which require the low clamping voltage and the low capacitance.

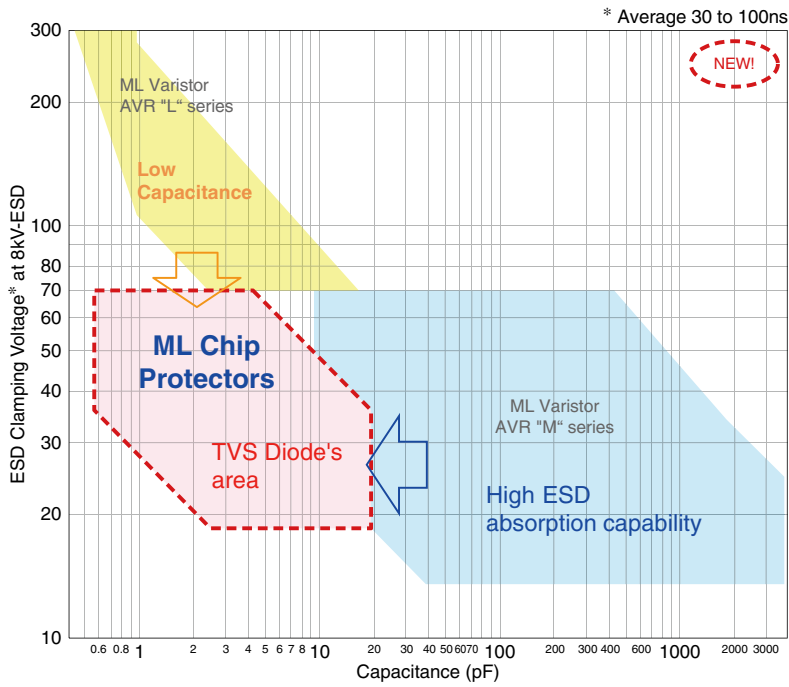

• All specifications are subject to change without notice.

Overview of the SGNE Series

RECOMMENDED REFLOW PROFILE

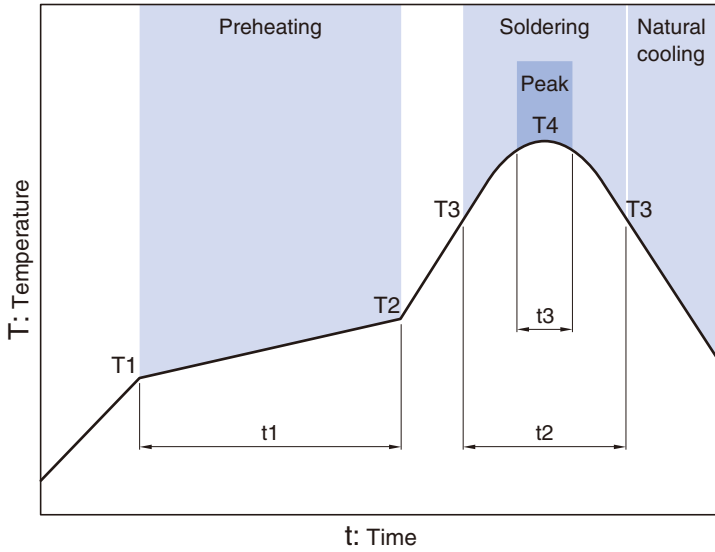

Preheating			Soldering		Peak	
Temp.	Temp.	Time	Temp.	Time	Temp.	Time
T1	T2	t1	T3	t2	T4	t3
150°C	180°C	120s max.	230°C	40s max.	260°C max.	5s

• All specifications are subject to change without notice.

SGNE series

SGNE04/SGNE06 Types

■ SHAPE & DIMENSIONS

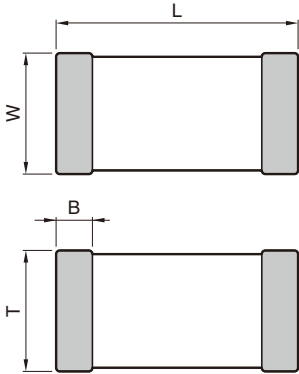

EIA	Dimensions in mm			
	L	W	T	B
01005	0.4±0.02	0.2±0.02	0.2±0.02	0.07min.
0201	0.6±0.03	0.3±0.03	0.3±0.03	0.1min.

■ RECOMMENDED LAND PATTERN

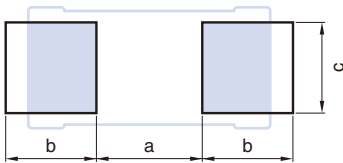

EIA	Dimensions in mm		
	a	b	c
01005	0.20	0.15 to 0.20	0.18 to 0.20
0201	0.25 to 0.35	0.20 to 0.30	0.25 to 0.35

■ CIRCUITS DIAGRAM

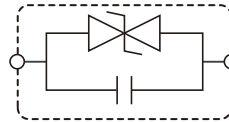

SGNE series **SGNE04/SGNE06** Types

■ ELECTRICAL CHARACTERISTICS

□ CHARACTERISTICS SPECIFICATION TABLE

Part No.	Maximum continuous voltage Vdc(V) max.	Breakdown voltage V(V) [1mA]	Capacitance C(pF) [1MHz]	Leakage current Vdc(μA) max.	ESD Clamp voltage Average Voltage (V) [IEC61000-4-2, 8kV] max.
EIA01005(0402mm)					
SGNE04C080MT150N25	4.3	8 (6.4 to 9.6)	15 (10.5 to 19.5)	20	25
EIA0201(0603mm)					
SGNE06C080MT150N25	4.3	8 (6.4 to 9.6)	15 (10.5 to 19.5)	20	25
SGNE06C270MT6R8G60	15	27 (21.6 to 32.4)	6.8 (4.8 to 8.8)	20	60

• Short bar residual inductance =0nH

SGNE series SGNE04/SGNE06 Types

ELECTRICAL CHARACTERISTICS

SGNE 0603mm Case Size

IMPEDANCE vs. FREQUENCY CHARACTERISTICS

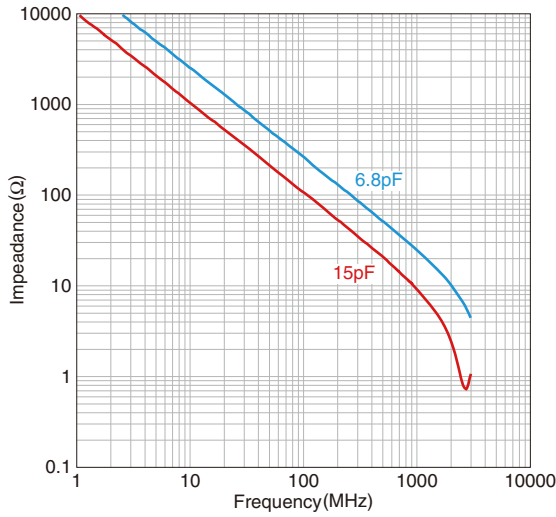

CAPACITANCE vs. FREQUENCY CHARACTERISTICS

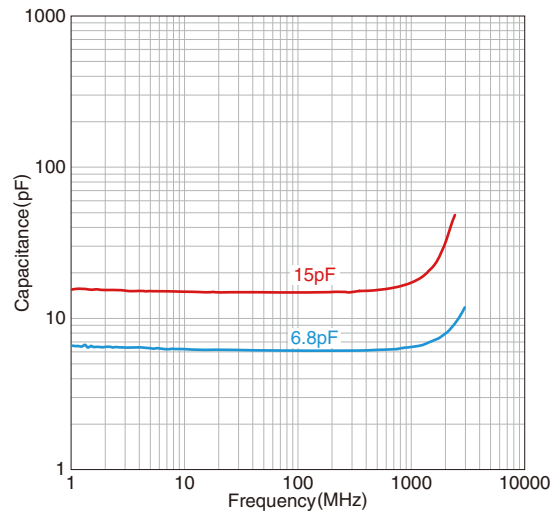

• Short bar residual inductance =0nH

SGNE 15pF Type

IMPEDANCE vs. FREQUENCY CHARACTERISTICS

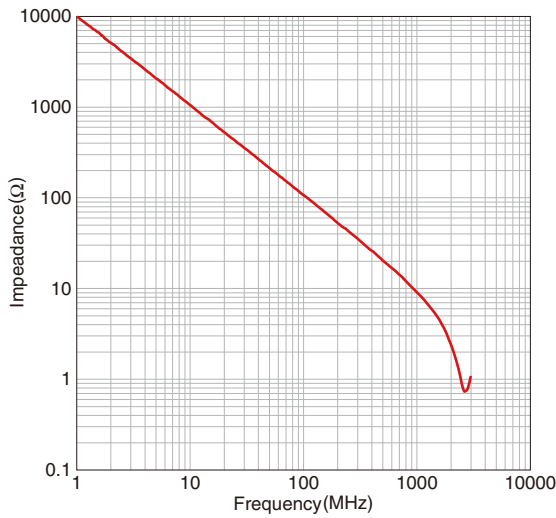

CAPACITANCE vs. FREQUENCY CHARACTERISTICS

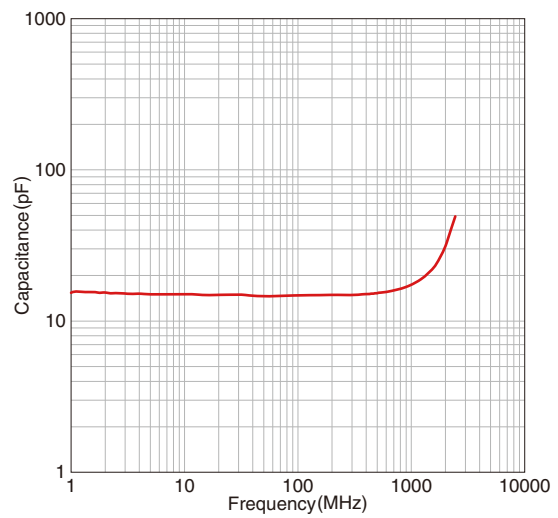

• Short bar residual inductance =0nH

• All specifications are subject to change without notice.

SGNE series SGNE04/SGNE06 Types

ESD CLAMP CHARACTERISTICS

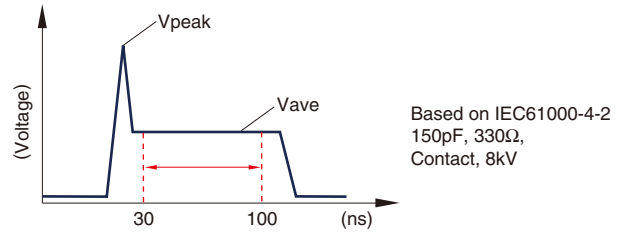
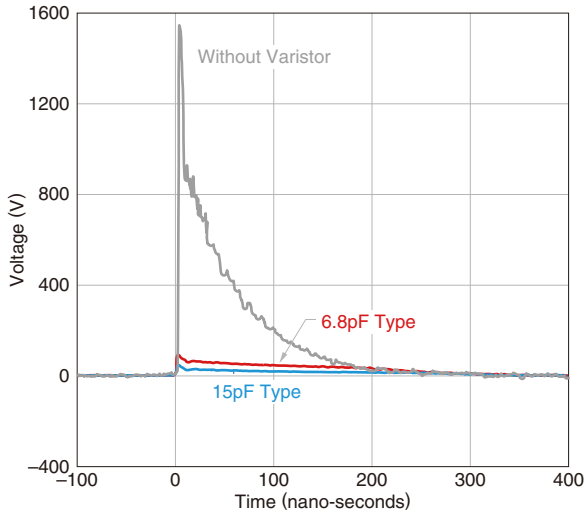

Part No.	ESD Clamping Voltage(V, at 8kV)	
	Vpeak	Vave
Without ESD Device	1561	395
SGNE06C080MT150N25	59	22
SGNE06C270MT6R8G60	99	51
SGNE04C080MT150N25	56	21

SGNE06C270MT6R8G60

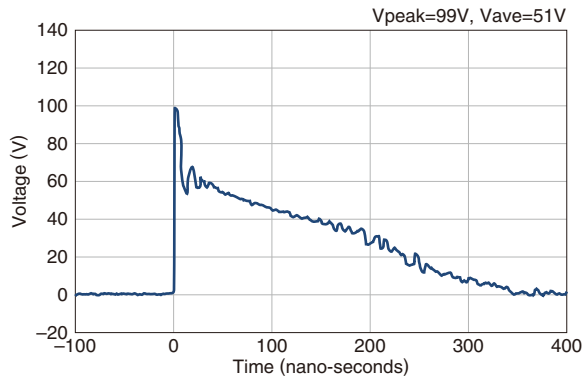

SGNE06C080MT150N25

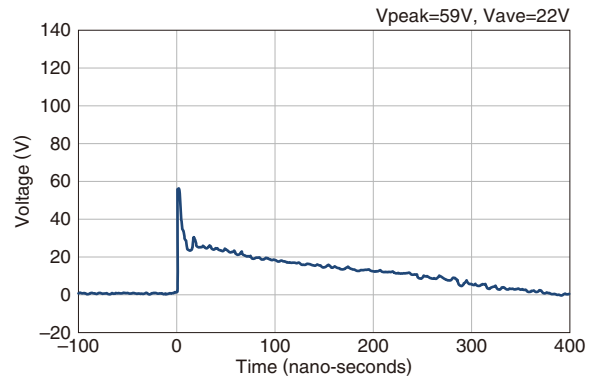

SGNE04C080MT150N25

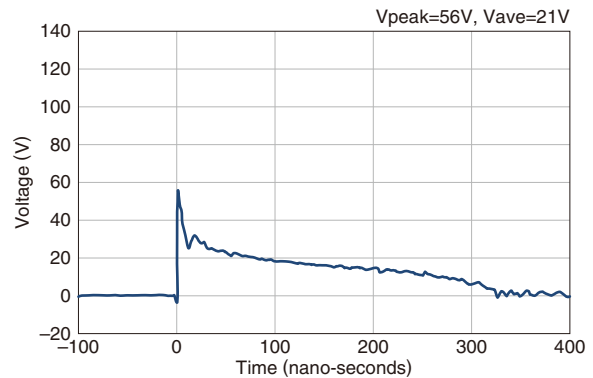

• All specifications are subject to change without notice.

SGNE series

Packaging Style

REEL DIMENSIONS

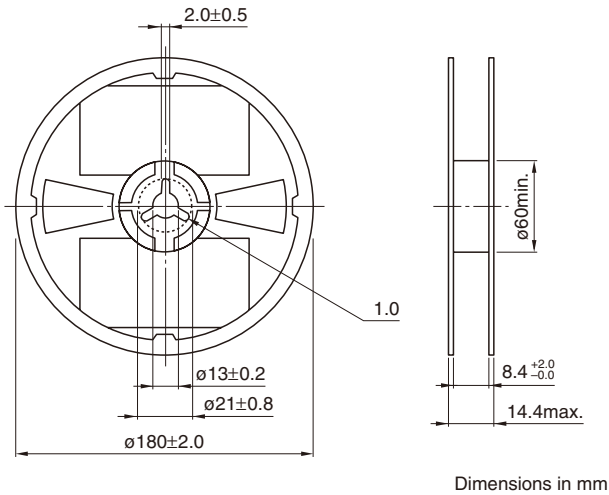

Dimensions in mm

TAPE DIMENSIONS

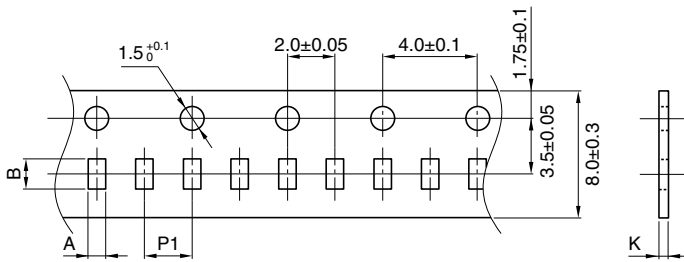

Dimensions in mm

Type	A	B	P1	K
SGNE0402	0.26 ± 0.04	0.46 ± 0.04	2.0 ± 0.05	0.4max.
SGNE0603	0.38 ± 0.05	0.68 ± 0.05	2.0 ± 0.05	0.45max.

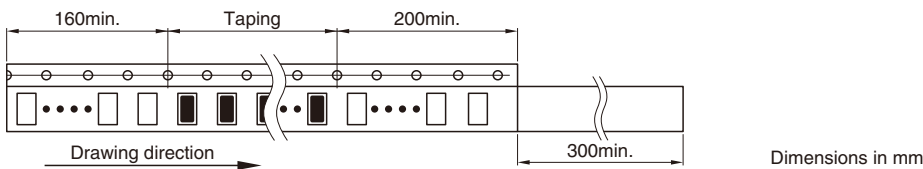

Dimensions in mm

• All specifications are subject to change without notice.