

**SF2304B**

**175 MHz  
SAW Filter**

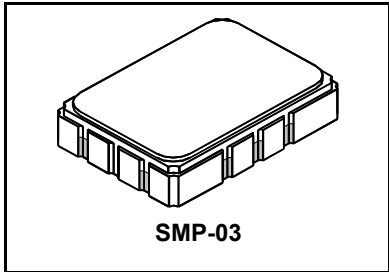

- **High Performance 175 MHz SAW Filter**
- **Hermetic 5 x 7 mm Surface-mount Case**
- **Single-ended or Differential Input Operation**
- **Complies with Directive 2002/95/EC (RoHS)**



**Absolute Maximum Ratings**

Rating	Value	Units
Maximum Incident Power in Passband	+10	dBm
DC Voltage on any Non-ground Terminal	10	VDC
Operating Temperature Range	-40 to +85	°C
Storage Temperature Range in Tape and Reel	-40 to +85	°C
Suitable for Lead-free Soldering - Maximum Soldering Profile	260 °C for 30 s	

Characteristic	Sym	Notes	Min	Typ	Max	Units
Center Frequency	$f_C$	1		175		MHz
Minimum insertion Loss	$IL_{MIN}$	1, 2		7.5	10	dB
Amplitude Ripple, $f_C \pm 0.45$ MHz				0.7	1.0	dB <sub>P-P</sub>
Group Delay Ripple, $f_C \pm 0.45$ MHz				200	300	ns <sub>P-P</sub>
Absolute Delay				0.68	1.50	µs
1 dB Bandwidth	$BW_1$		0.90	1.04		MHz
2.5 dB Bandwidth	$BW_{2.5}$		1.20	1.38		
3 dB Bandwidth	$BW_3$		1.30	1.46		
5 dB Bandwidth	$BW_5$		1.55	1.66	1.85	
30 dB Bandwidth	$BW_{30}$			3.21	3.65	
40 dB Bandwidth	$BW_{40}$			3.47	3.95	
Ultimate Rejection, 186 to 900 MHz			47	50		dB
Input/Output Return Loss, $f_C \pm 0.45$ MHz			10	12		dB

Single-ended Terminating Source Impedance		$Z_S = 50$ ohms
Differential Terminating Source Impedance		$Z_S = 100$ ohms
Terminating Load Impedance		$Z_L = 50$ ohms
Case Style	6	SMP-03 7 x 5 mm Nominal Footprint
Lid Symbolization, YY = year, WW = week		RFM/SF2304B/YYWW

**Electrical Connection**

Connection	Terminals
Single-ended Input Port	10
Balanced Input Port	10, 1
Single-ended Output Port	5
Ground	All others

**NOTES:**

1. Unless noted otherwise, all specifications apply over the operating temperature range with filter soldered to the specified demonstration board with impedance matching to 50 Ω and measured with 50 Ω network analyzer.
2. Unless noted otherwise, all frequency specifications are referenced to the nominal center frequency,  $f_C$ .
3. Rejection is measured as attenuation below the minimum IL point in the passband. Rejection in final user application is dependent on PCB layout and external impedance matching design. See Application Note No. 42 for details.
4. "LRIP" or "L" after the part number indicates "low rate initial production" and "ENG" or "E" indicates "engineering prototypes."
5. The design, manufacturing process, and specifications of this filter are subject to change.
6. Tape and Reel Standard ANSI / EIA 481.
7. Either Port 1 or Port 2 may be used for either input or output in the design. However, impedances and impedance matching may vary between Port 1 and Port 2, so that the filter must always be installed in one direction per the circuit design.
8. US and international patents may apply.
9. Electrostatic Sensitive Device. Observe precautions for handling.

# Filter Response Plots

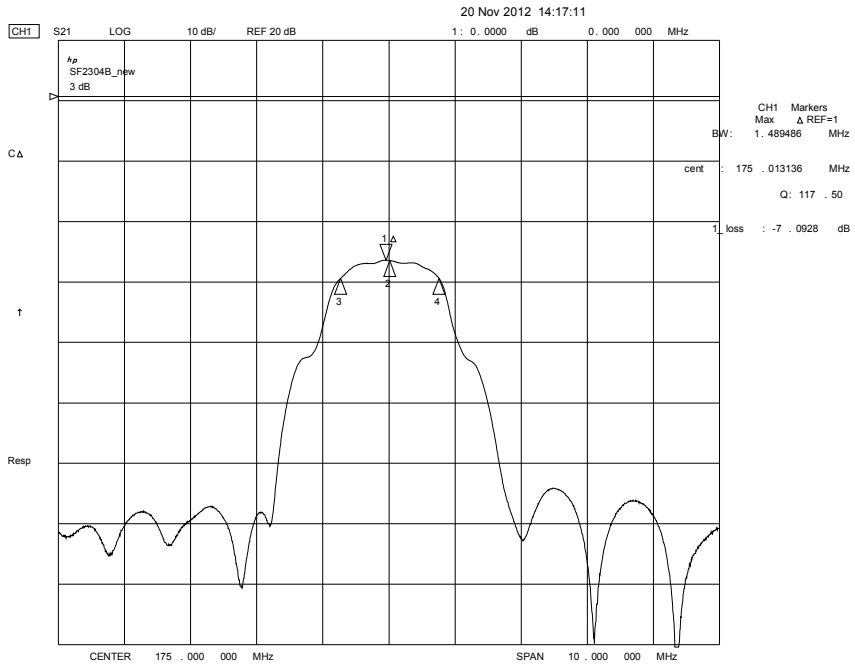
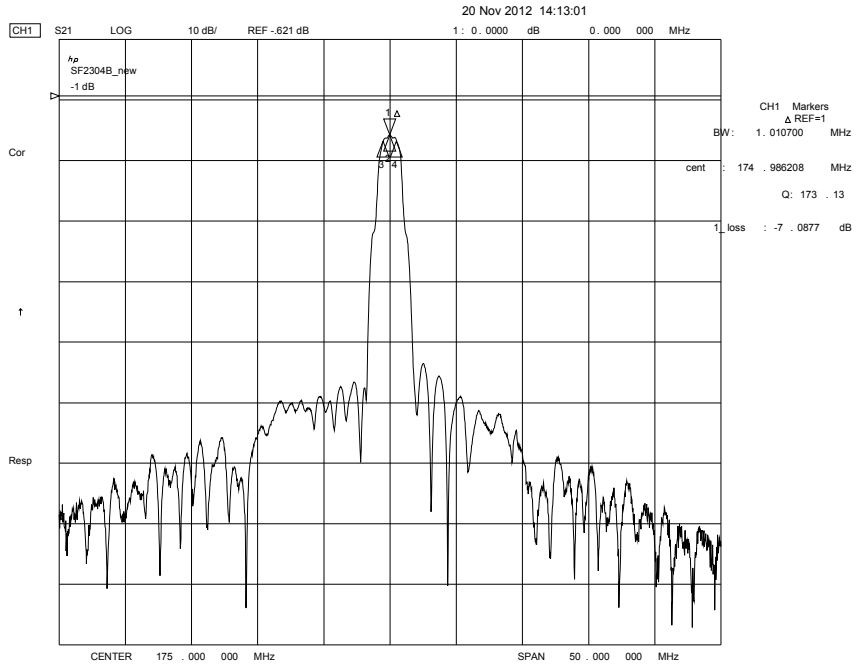

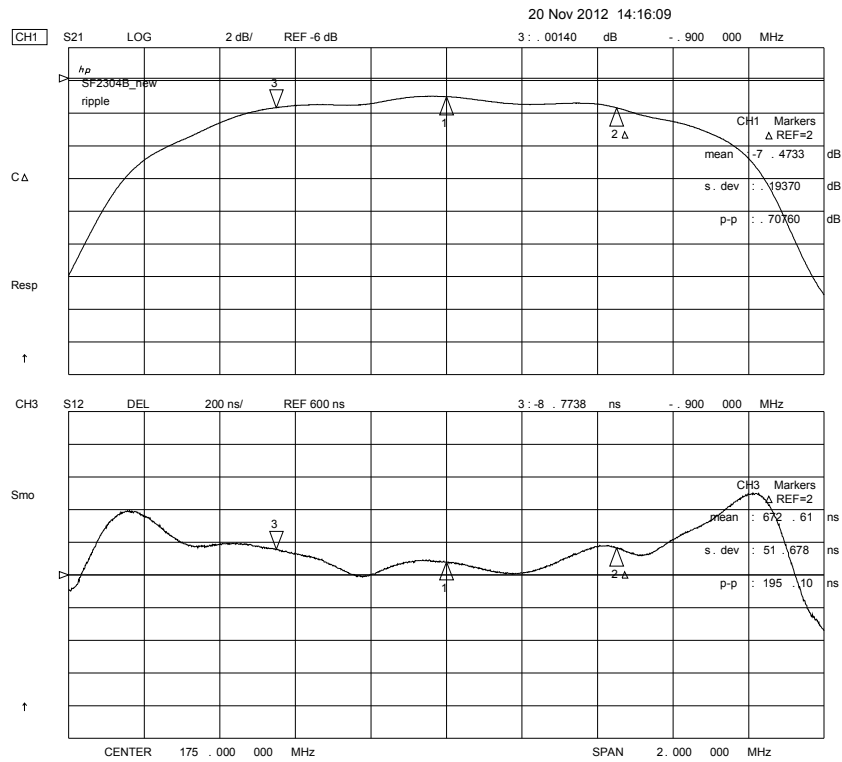

## Typical Matching Network

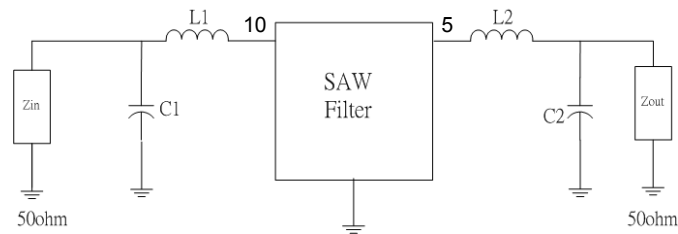

$$C1 = 33 \text{ pF}, L1 = (150 + 22) \text{ nH}, L2 = (24 + 150) \text{ nH}, C2 = 36 \text{ pF}$$

# SMP-03 10-Terminal Ceramic Surface-mount Case

## 5 x 7 mm Nominal Footprint

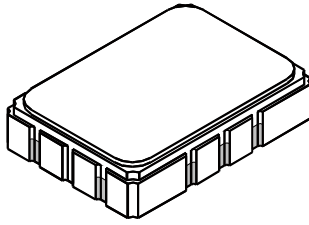

### Recommended PCB Footprint

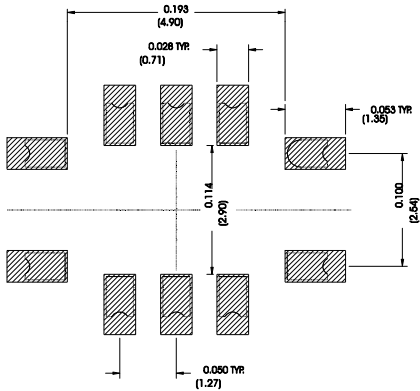

Case Dimensions						
Dimension	mm			Inches		
	Min	Nom	Max	Min	Nom	Max
A	6.80	7.00	7.20	0.268	0.276	0.283
B	4.80	5.00	5.20	0.189	0.197	0.205
C	-	1.65	2.00	-	0.065	0.079
D	0.47	0.60	0.73	0.019	0.024	0.029
E	2.41	2.54	2.67	0.095	0.100	0.105
H	0.87	1.0	1.13	0.034	0.039	0.044
J	4.87	5.00	5.13	0.192	0.197	0.202
K	2.87	3.00	3.13	0.113	0.118	0.123
P	1.14	1.27	1.40	0.045	0.050	0.055

Electrical Connections		
Connection	Terminals	
Port 1	Single-ended Input	10
Port 1	Differential Input	10, 1
Port 2	Single-ended Output	5
	Ground	All others

Case Materials	
Solder Pad Plating	0.3 to 1.0 $\mu\text{m}$ Gold over 1.27 to 8.89 $\mu\text{m}$ Nickel
Lid Plating	2.0 to 3.0 $\mu\text{m}$ Nickel
Body	$\text{Al}_2\text{O}_3$ Ceramic
Pb Free	

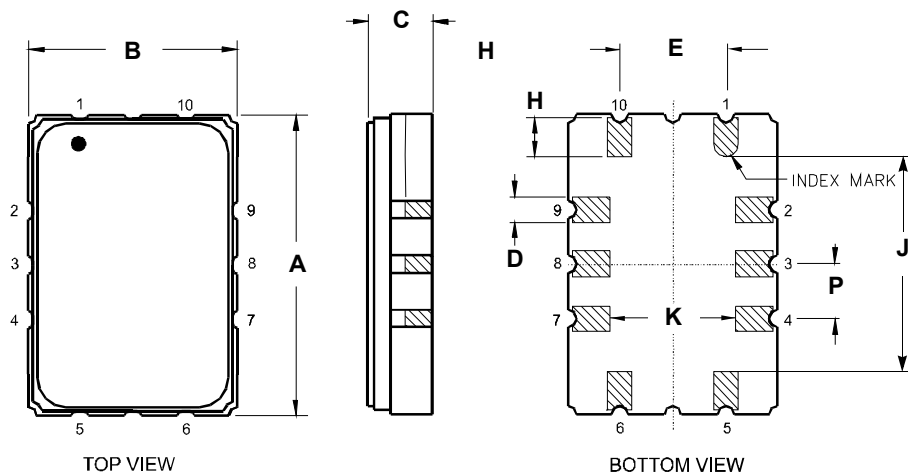

# Tape and Reel Specifications

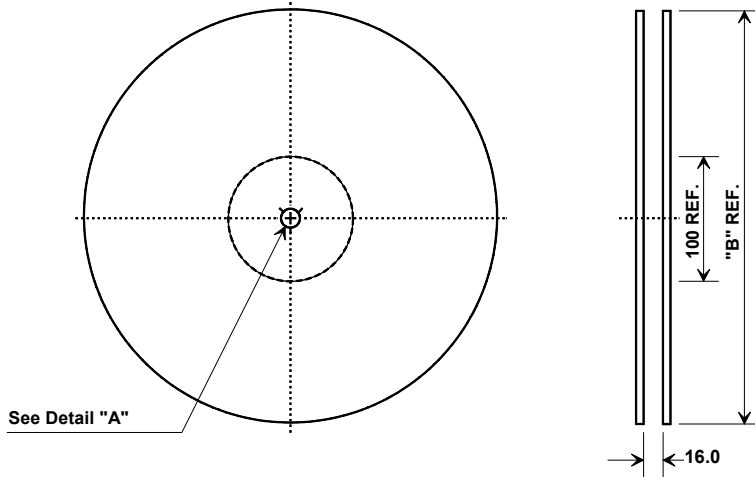

"B"		Quantity Per Reel
Nominal Size		
Inches	millimeters	
7	178	500
13	330	2000

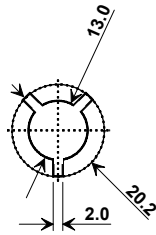

## COMPONENT ORIENTATION and DIMENSIONS

Carrier Tape Dimensions	
Ao	5.6 mm
Bo	7.6 mm
Ko	2.0 mm
Pitch	8.0 mm
W	16.0 mm

