

ISOLATED DC/DC CONVERTERS

48 Vdc Input 12 Vdc/12 A, 3.3 Vdc/46 A, 5 Vdc/30 A, 1.2-2.5 Vdc/50 A Outputs



0RQB-C5T Series

RoHS Compliant

Rev.B

- Isolated
- High Efficiency
- High Power Density
- Low Cost
- Input Under Voltage Lockout
- Fixed Frequency (330 kHz)
- Active Low/High (Option)
- UL60950-1 Recognized (UL/cUL)
- Output Over Voltage Shutdown
- OCP/SCP
- Over Temperature Protection
- Remote On/Off
- Output Voltage Trim
- Positive/Negative Remote Sense
- Input Over Voltage Lockout
- Basic Isolation



Description

The 0RQB-C5T Series are isolated dc/dc converters that operate from a nominal 48 Vdc source. These units will provide up to 150 W of output power from a nominal 48 Vdc input. These units are designed to be highly efficient and low cost. Typical efficiency of 12 Vdc output at 48 Vdc input at full load is 93%. Features include remote on/off, over current protection and under-voltage lockout. These converters are provided in an industry standard quarter brick package.

Part Selection

| Output Voltage | Input Voltage | Max. Output Current | Max. Output Power | Typical Efficiency | Model Number Active High | Model Number Active Low |
|----------------|---------------|---------------------|-------------------|--------------------|--------------------------|-------------------------|
| 12 V | 36 V - 75 V | 12 A | 144 W | 93.0% | 0RQB-C5T120 | 0RQB-C5T12L |
| 5.0 V | 36 V - 75 V | 30 A | 150 W | 92.5% | 0RQB-C5T050 | 0RQB-C5T05L |
| 3.3 V | 36 V - 75 V | 46 A | 152 W | 91.0% | 0RQB-C5T033 | 0RQB-C5T03L |
| 2.5 V | 36 V - 75 V | 50 A | 125 W | 90.5% | 0RQB-C5T025 | 0RQB-C5T02L |
| 1.8 V | 36 V - 75 V | 50 A | 90 W | 88.0% | 0RQB-C5TV80 | 0RQB-C5TV8L |
| 1.5 V | 36 V - 75 V | 50 A | 75 W | 85.0% | 0RQB-C5TV50 | 0RQB-C5TV5L |
| 1.2 V | 36 V - 75 V | 50 A | 60 W | 83.0% | 0RQB-C5TV20 | 0RQB-C5TV2L |

Notes: 1. Add "G" suffix at the end of the model number to indicate Tray Packaging.

2. All part numbers above indicate RoHS 6. Change the second letter "R" to "7" for RoHS 5 part numbers.

Absolute Maximum Ratings

| Parameter | Min | Typ | Max | Notes |
|----------------------------|--------|-----|--------|-------|
| Input Voltage (continuous) | -0.3 V | - | 80 V | |
| Remote On/Off | -0.3 V | - | 18 V | |
| I/O Isolation Voltage | - | - | 2000 V | |
| Ambient Temperature | -40 °C | - | 85 °C | |
| Storage Temperature | -55 °C | - | 125 °C | |

Note: All specifications are typical at nominal input, full load at 25 °C unless noted.

ISOLATED DC/DC CONVERTERS

48 Vdc Input 12 Vdc/12 A, 3.3 Vdc/46 A, 5 Vdc/30 A, 1.2-2.5 Vdc/50 A Outputs



Input Specifications

| Parameter | Min | Typ | Max | Notes |
|---|------|-----------------------|----------------------|--|
| Input Voltage | 36 V | 48 V | 75 V | |
| Input Current (full load) | | | | |
| Vo=12 V | - | - | 4.5 A | |
| Vo=5.0 V | - | - | 4.9 A | |
| Vo=3.3 V | - | - | 4.9 A | |
| Vo=2.5 V | - | - | 4.1 A | |
| Vo=1.8 V | - | - | 3.0 A | |
| Vo=1.5 V | - | - | 2.6 A | |
| Vo=1.2 V | - | - | 2.1 A | |
| Input Current (no load) | - | 120 mA | 180 mA | |
| Remote Off Input Current | | 10 mA | 15 mA | |
| Input Reflected Ripple Current (pk-pk) | - | 10 mA | 15 mA | Tested with simulated source impedance of 10 μ H, 5 Hz to 20 MHz; use a 100 μ F /100 V electrolytic capacitor with ESR = 1 ohm max. at 200 kHz at 25 °C. |
| Input Reflected Ripple Current (rms) | - | 1.5 mA | 3 mA | |
| I ² t Inrush Current Transient | - | 0.05 A ² s | 0.1 A ² s | |
| Turn-on Voltage Threshold | 32 V | 34 V | 35 V | |
| Turn-off Voltage Threshold | 30 V | 32 V | 34 V | |
| Input over voltage Lockout | 76 V | 78 V | 80 V | |

Note: All specifications are typical at nominal input, full load at 25 °C unless noted.

Output Specifications

| Parameter | Min | Typ | Max | Notes |
|--|-------------|----------|------------|---|
| Output Voltage Set Point | | | | |
| Vo=12 V | 11.790 V | 12.030 V | 12.270 V | Vin=48 V, Io=50% full load |
| Vo=5.0 V | 4.925 V | 5.004 V | 5.075 V | |
| Vo=3.3 V | 3.260 V | 3.308 V | 3.360 V | |
| Vo=2.5 V | 2.450 V | 2.503 V | 2.550 V | |
| Vo=1.8 V | 1.770 V | 1.808 V | 1.844 V | |
| Vo=1.5 V | 1.477 V | 1.500 V | 1.523 V | |
| Vo=1.2 V | 1.176 V | 1.200 V | 1.224 V | |
| Output Voltage Set Point | -3.5%Vo,set | - | 3.5%Vo,set | Over all operating input voltage, resistive load, and temperature conditions. |
| Line Regulation | | | | |
| Vo=12 V | - | ±8 mV | ±15 mV | |
| Vo=5.0 V | - | ±5 mV | ±15 mV | |
| Vo=1.2 V-3.3 V | - | ±3 mV | ±6 mV | |
| Load Regulation | | | | |
| Vo=5.0 V-12 V | - | ±10 mV | ±20 mV | |
| Vo=2.5 V-3.3 V | - | ±5 mV | ±10 mV | |
| Vo=1.2 V-1.8 V | - | ±2 mV | ±5 mV | |
| Regulation Over Temperature (-40 °C to +85 °C) | | | | |
| Vo=12 V | - | ±60 mV | ±100 mV | |
| Vo=5.0 V | - | ±40 mV | ±65 mV | |
| Vo=3.3 V | - | ±30 mV | ±50 mV | |
| Vo=2.5 V | - | ±20 mV | ±40 mV | |
| Vo=1.8 V-1.2 V | - | ±15 mV | ±30 mV | |
| Output Current | | | | |
| Vo=12 V | 0 A | - | 12 A | |
| Vo=5.0 V | 0 A | - | 30 A | |
| Vo=3.3 V | 0 A | - | 46 A | |
| Vo=1.2 V-2.5 V | 0 A | - | 50 A | |

ISOLATED DC/DC CONVERTERS

48 Vdc Input 12 Vdc/12 A, 3.3 Vdc/46 A, 5 Vdc/30 A, 1.2-2.5 Vdc/50 A Outputs



Output Specifications (continued)

| Parameter | Min | Typ | Max | Notes |
|-------------------------------|-------|--------------------|--------------------|---|
| Current Limit Threshold | | | | |
| Vo=12 V | 14 A | 15.5 A | 18 A | |
| Vo=5.0 V | 35 A | 40 A | 45 A | |
| Vo=3.3 V | 50 A | 60 A | 65 A | |
| Vo=1.2 V-2.5 V | 55 A | 60 A | 65 A | |
| Short Circuit Surge Transient | - | 3 A ² s | 5 A ² s | |
| Ripple and Noise (rms) | | | | |
| Vo=12 V | - | 25 mV | 30 mV | Test conditions: 0-20 MHz BW, with a 1 uF ceramic capacitor and a 10 uF Tantalum capacitor at the output. |
| Vo=5.0 V | - | 20 mV | 25 mV | |
| Vo=3.3 V | - | 20 mV | 20 mV | |
| Vo=1.2 V-2.5 V | - | 15 mV | 20 mV | |
| Ripple and Noise (pk-pk) | | | | |
| Vo=12 V | - | 70 mV | 90 mV | Test conditions: 0-20 MHz BW, with a 1 uF ceramic capacitor and a 10 uF Tantalum capacitor at the output. |
| Vo=5.0 V | - | 60 mV | 80 mV | |
| Vo=3.3 V | - | 50 mV | 70 mV | |
| Vo=1.8 V | - | 45 mV | 60 mV | |
| Vo=2.5 V | - | 40 mV | 60 mV | |
| Vo=1.5 V | - | 55 mV | 70 mV | |
| Vo=1.2 V | - | 40 mV | 60 mV | |
| Turn on Time | 10 mS | - | 100 mS | |
| Overshoot at Turn on | - | 0% | 5% | |
| Output Capacitance | | | | |
| Vo=12.0 V | 0 uF | - | 2200 uF | |
| Vo=5.0 V | 0 uF | - | 10000 uF | |
| Vo=1.2 V-3.3 V | 0 uF | - | 20000 uF | |

Transient Response

| | | | | | | |
|-----------------------|---------------|-----------|---|--------|--------|--|
| 50% ~ 75% Max Load | Overshoot | Vo=12.0 V | - | 600 mV | 800 mV | Test conditions: di/dt = 0.1 A/uS, Vin=48 V, with a 1 uF ceramic capacitor and a 10 uF Tantalum capacitor at the output. |
| | Settling Time | | - | 200 uS | 300 uS | |
| 75% ~ 50% Max Load | Overshoot | Vo=12.0 V | - | 600 mV | 800 mV | |
| | Settling Time | | - | 200 uS | 300 uS | |
| 50% ~ 75% Max Load | Overshoot | Vo=5.0 V | - | 250 mV | 375 mV | |
| | Settling Time | | - | 100 uS | 200 uS | |
| 75% ~ 50% Max Load | Overshoot | Vo=5.0 V | - | 250 mV | 375 mV | |
| | Settling Time | | - | 100 uS | 200 uS | |
| 50% ~ 75% Max Load | Overshoot | Vo=3.3 V | - | 100 mV | 200 mV | |
| | Settling Time | | - | 200 uS | 300 uS | |
| 75% ~ 50% Max Load | Overshoot | Vo=3.3 V | - | 100 mV | 200 mV | |
| | Settling Time | | - | 200 uS | 300 uS | |
| 50% ~ 75% Max Load | Overshoot | Vo=2.5 V | - | 100 mV | 200 mV | |
| | Settling Time | | - | 300 uS | 400 uS | |
| 75% ~ 50% Max Load | Overshoot | Vo=2.5 V | - | 100 mV | 200 mV | |
| | Settling Time | | - | 300 uS | 400 uS | |
| 50% ~ 75% Max Load | Overshoot | Vo=1.8 V | - | 100 mV | 140 mV | |
| | Settling Time | | - | 200 uS | 300 uS | |
| 75% ~ 50% Max Load | Overshoot | Vo=1.5 V | - | 100 mV | 140 mV | |
| | Settling Time | | - | 200 uS | 300 uS | |
| 50% ~ 75% Max Load | Overshoot | Vo=1.2 V | - | 100 mV | 120 mV | |
| | Settling Time | | - | 200 uS | 300 uS | |
| 75% ~ 50% Max Load | Overshoot | Vo=1.2 V | - | 100 mV | 120 mV | |
| | Settling Time | | - | 200 uS | 300 uS | |

Note: All specifications are typical at nominal input, full load at 25 °C unless noted.

ISOLATED DC/DC CONVERTERS

48 Vdc Input 12 Vdc/12 A, 3.3 Vdc/46 A, 5 Vdc/30 A, 1.2-2.5 Vdc/50 A Outputs



General Specifications

| Parameter | Min | Typ | Max | Notes | |
|-----------------------------------|-----------------|-----------------------|---------|--|-------------------------------|
| Efficiency | Vo=12 V | 90% | 93% | - | Vin=48 V, full load, Ta=25 °C |
| | Vo=5.0 V | 89% | 92.5% | - | |
| | Vo=3.3 V | 88% | 91% | - | |
| | Vo=2.5 V | 87% | 90.5% | - | |
| | Vo=1.8 V | 85% | 88% | - | |
| | Vo=1.5 V | 82% | 85% | - | |
| | Vo=1.2 V | 80% | 83% | - | |
| Switching Frequency | 280 kHz | 330 kHz | 380 kHz | | |
| Isolation capacitance | - | 1500 pF | - | | |
| Input to Output Isolation Voltage | - | - | 2000 V | | |
| Remote Sense Compensation | - | - | 10% Vo | The total voltage increased by trim and remote sense should not exceed 10%Vo. | |
| Output Voltage Trim Range | 80% Vo | - | 110% Vo | | |
| Over Temperature Protection | - | 125 °C | - | | |
| Over Voltage Protection | - | 130% Vo | - | Vin=48V, full load, Hiccup mode | |
| MTBF | 1,109,917 hours | | | Calculated Per Bell Core SR-332 (Io =80% load, Vin=48 V, Vo=3.3 V; Ta = 25 °C) | |
| Dimensions | Inches | 2.30 x 1.45 x 0.395 | | | |
| | millimeters | 58.42 x 36.83 x 10.03 | | | |
| Weight | - | 41 g | - | | |

Note: All specifications are typical at nominal input, full load at 25 °C unless noted.

Control Specifications

| Parameter | Min | Typ | Max | Notes | |
|------------------------|-------------|--------|---------|-------|--|
| Remote On/Off | | | | | |
| Signal Low (Unit On) | Active Low | -0.3 V | - | 0.8 V | 0RQB-C5TxxL. The remote on/off pin open, Unit off. |
| Signal High (Unit Off) | | 2.4 V | - | | |
| Signal Low (Unit Off) | Active High | -0.3 V | - | 0.8 V | 0RQB-C5Txx0. The remote on/off pin open, Unit on. |
| Signal High (Unit On) | | 2.4 V | - | | |
| Current Sink | 0 mA | - | 0.75 mA | | |

ISOLATED DC/DC CONVERTERS

48 Vdc Input 12 Vdc/12 A, 3.3 Vdc/46 A, 5 Vdc/30 A, 1.2-2.5 Vdc/50 A Outputs

bel
POWER PRODUCTS

Output Trim Equations

Equations for calculating the trim resistor are shown below (Unit: kΩ). The Trim Down resistor should be connected between the Trim pin and Ground pin. The Trim Up resistor should be connected between the Trim pin and the Vout. Only one of the resistors should be used for any given application.

1) For $V_o=1.5\text{ V} - 12\text{ V}$:

$$R_{trimdown} = \frac{511}{|\delta|} - 10.22$$

$$R_{trimup} = \frac{(100 + \delta) \cdot V_o \cdot 5.11 - 626}{1.225 \cdot \delta} - 10.22$$

Note:

$$\delta = \frac{(V_{o_req} - V_o)}{V_o} \times 100[\%]$$

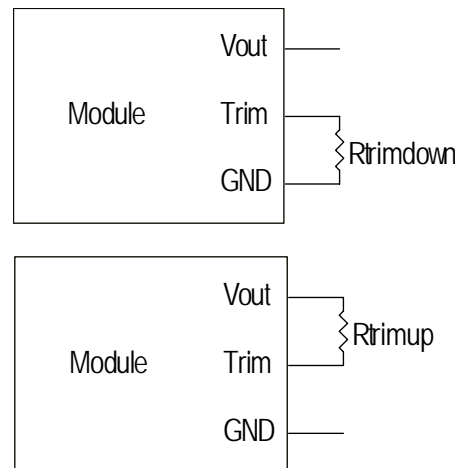

V_{o_req} =Desired (trimmed) output voltage [V]; V_o =output voltage
 $V_o=12.004\text{ V}$ for 12 V output; $V_o=5\text{ V}$ for 5.004 V output; $V_o=3.308\text{ V}$ for 3.3 V output; $V_o=2.503\text{ V}$ for 2.5 V output; $V_o=1.808\text{ V}$ for 1.8 V output; $V_o=1.503\text{ V}$ for 1.5 V output

2) For $V_o=1.2\text{ V}$:

$$R_{trimdown} = \frac{511}{|\delta|} - 10.22$$

$$R_{trimup} = \frac{(100 + \delta) \cdot V_o \cdot 5.11 - 313}{0.6125 \cdot \delta} - 10.22$$

Note:

$$\delta = \frac{(V_{o_req} - V_o)}{V_o} \times 100[\%]$$

V_{o_req} =Desired (trimmed) output voltage [V]; V_o =output voltage
 $V_o=1.202\text{ V}$ for 1.2 V output

ISOLATED DC/DC CONVERTERS

48 Vdc Input 12 Vdc/12 A, 3.3 Vdc/46 A, 5 Vdc/30 A, 1.2-2.5 Vdc/50 A Outputs



Efficiency Data

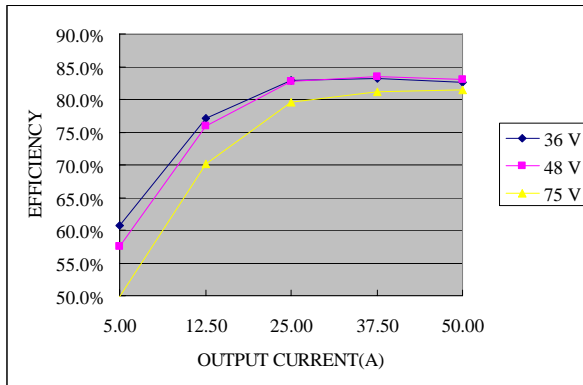

0RQB-C5TV2x

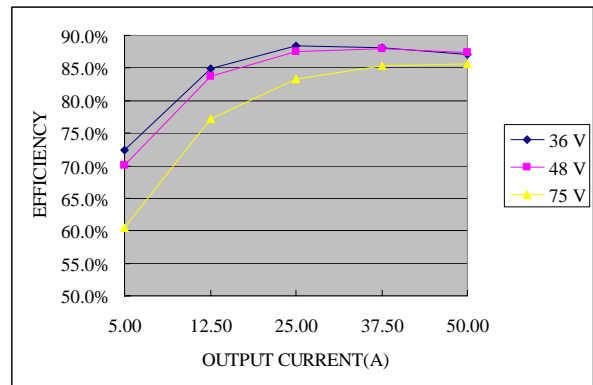

0RQB-C5TV5x

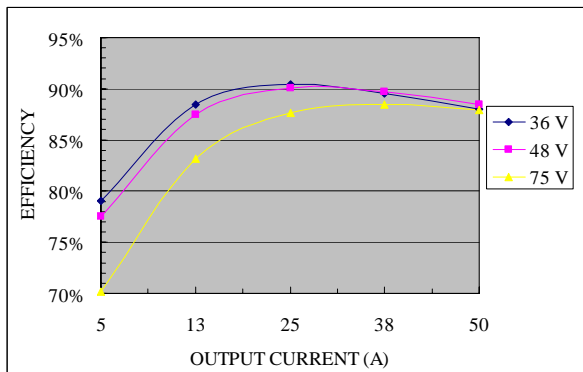

0RQB-C5TV8x

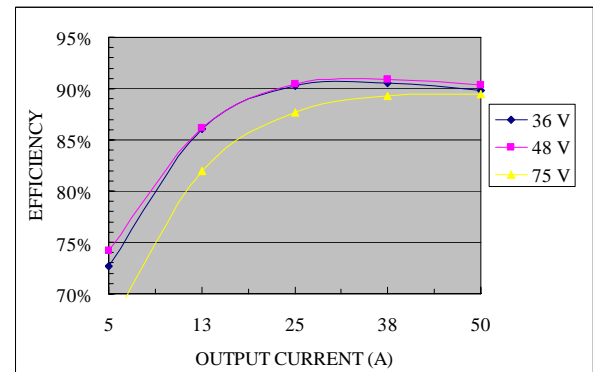

0RQB-C5T02x

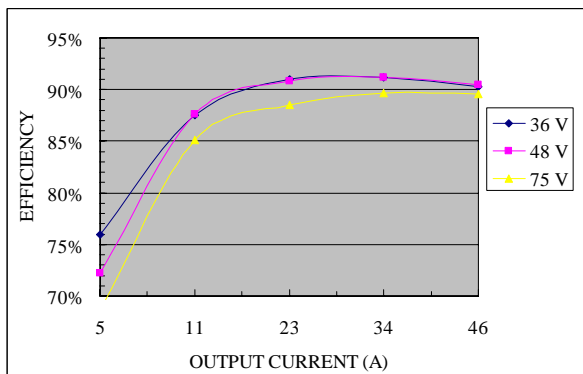

0RQB-C5T03x

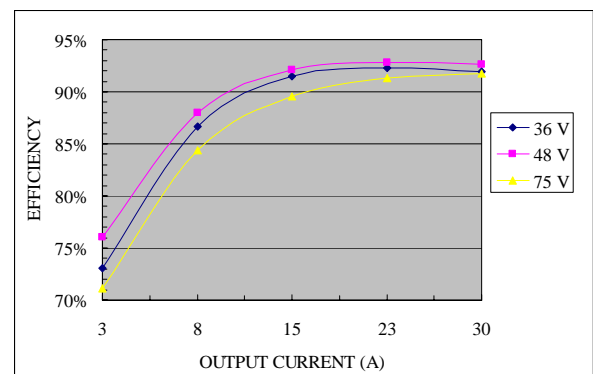

0RQB-C5T05x

ISOLATED DC/DC CONVERTERS

48 Vdc Input 12 Vdc/12 A, 3.3 Vdc/46 A, 5 Vdc/30 A, 1.2-2.5 Vdc/50 A Outputs



Efficiency Data (continued)

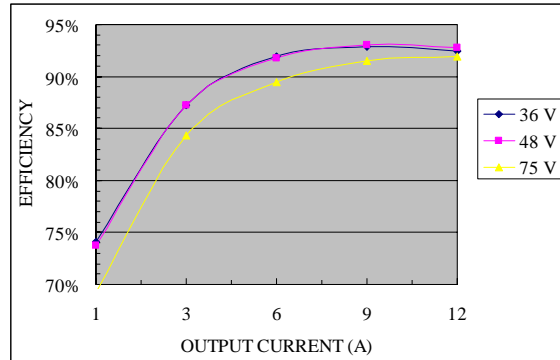

0RQB-C5T12x

Thermal Derating Curves

Vin=48V, with maximum junction temperature of semiconductors derated to 120 degree C.

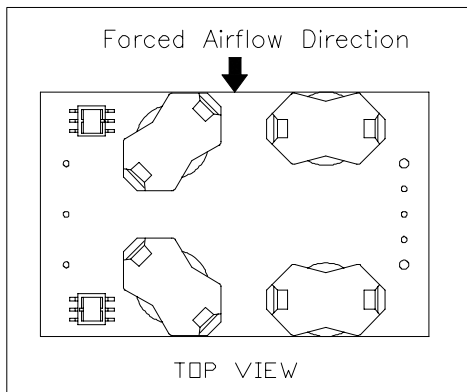

0RQB-C5Txxx

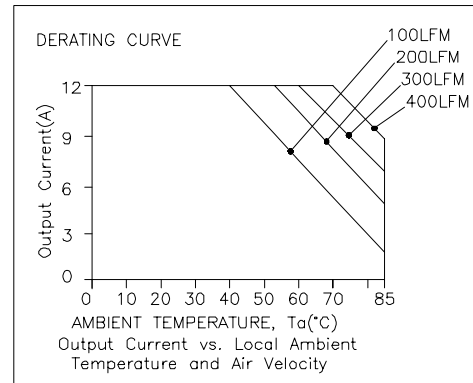

0RQB-C5T12x

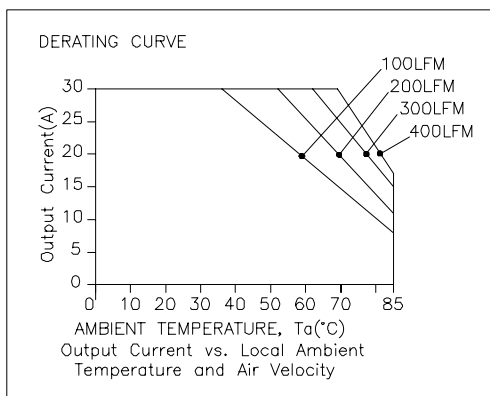

0RQB-C5T05x

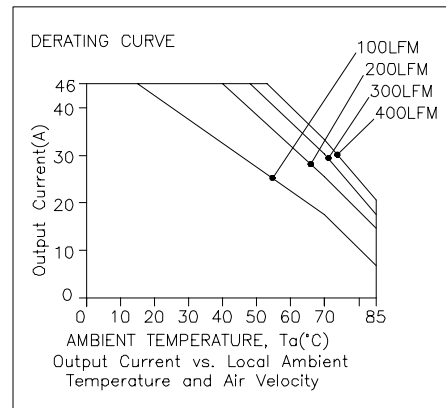

0RQB-C5T03x

ISOLATED DC/DC CONVERTERS

48 Vdc Input 12 Vdc/12 A, 3.3 Vdc/46 A, 5 Vdc/30 A, 1.2-2.5 Vdc/50 A Outputs



Thermal Derating Curves (continued)

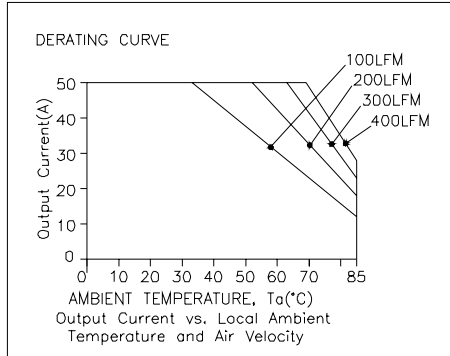

0RQB-C5T02x

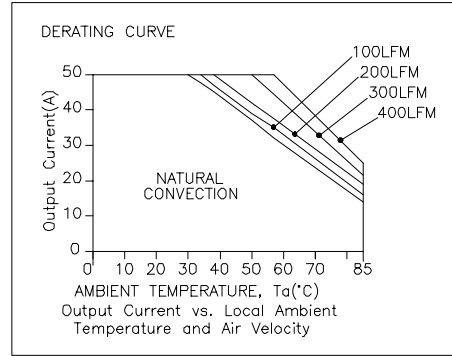

0RQB-C5TV8x

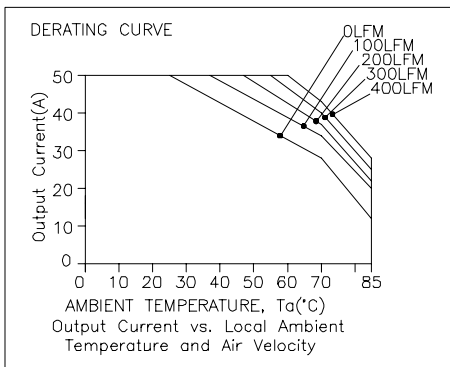

0RQB-C5TV5x

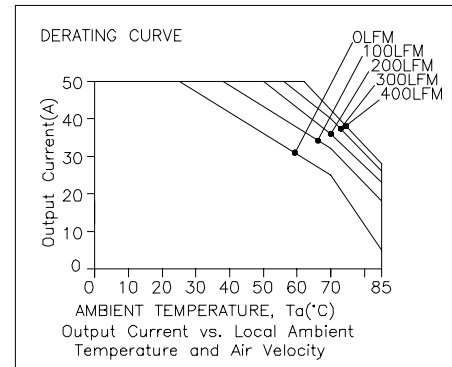

0RQB-C5TV2x

Thermal Reference

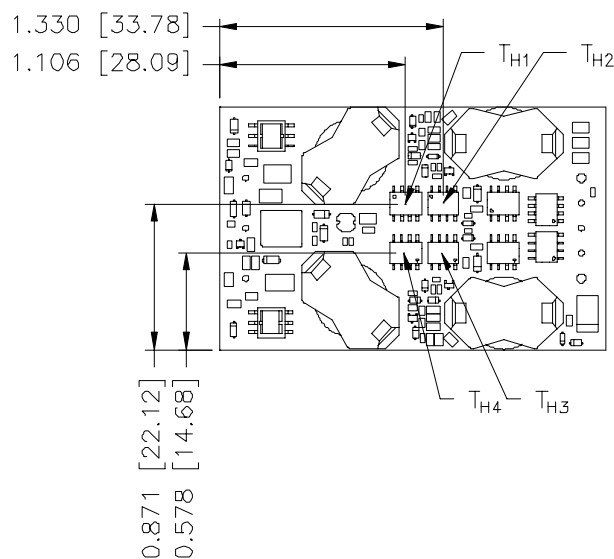

Note: TH1, TH2, TH3 and TH4 are hot spots which should not exceed 115 degree C.

ISOLATED DC/DC CONVERTERS

48 Vdc Input 12 Vdc/12 A, 3.3 Vdc/46 A, 5 Vdc/30 A, 1.2-2.5 Vdc/50 A Outputs



Ripple and Noise Waveforms

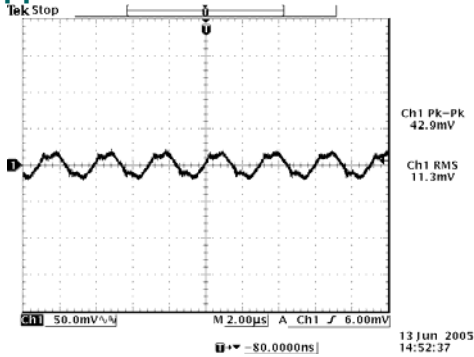

Ripple and noise at full load, 1.2 V/50 A output

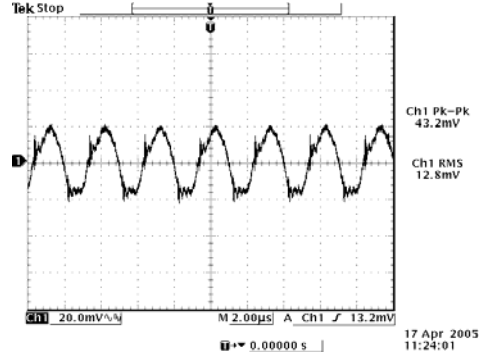

Ripple and noise at full load, 1.5 V/50 A output

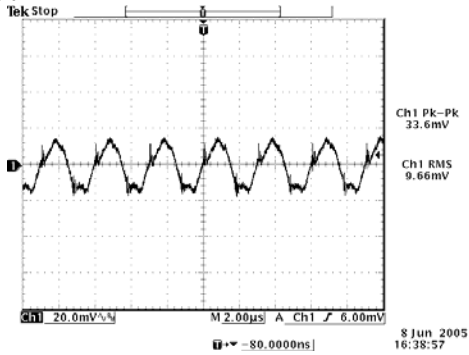

Ripple and noise at full load, 1.8 V/50 A output

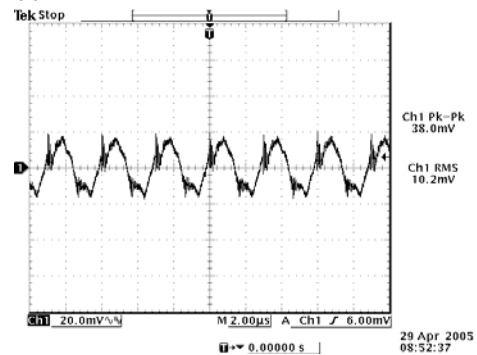

Ripple and noise at full load, 2.5 V/45 A output

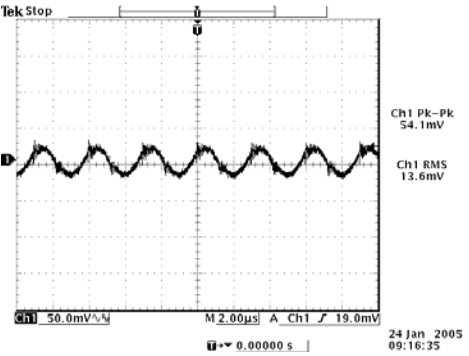

Ripple and noise at full load, 3.3 V/46 A output

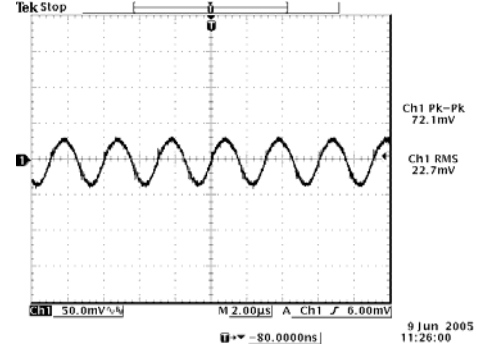

Ripple and noise at full load, 5.0 V/30 A output

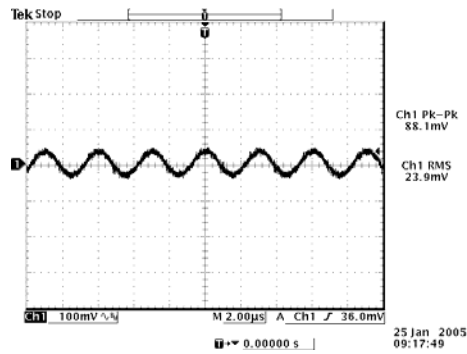

Ripple and noise at full load, 12 V/12 A output

Note: Ripple and noise is tested with a 1 μ F ceramic cap and a 10 μ F tantalum capat output, $T_a=25$ deg C.

ISOLATED DC/DC CONVERTERS

48 Vdc Input 12 Vdc/12 A, 3.3 Vdc/46 A, 5 Vdc/30 A, 1.2-2.5 Vdc/50 A Outputs



Transient Response Waveforms

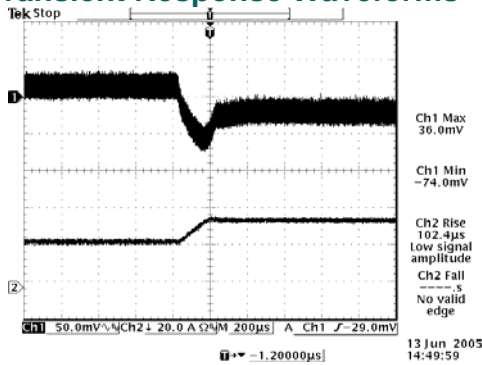

Vout= 1.2 V 50%-75% Load Transients

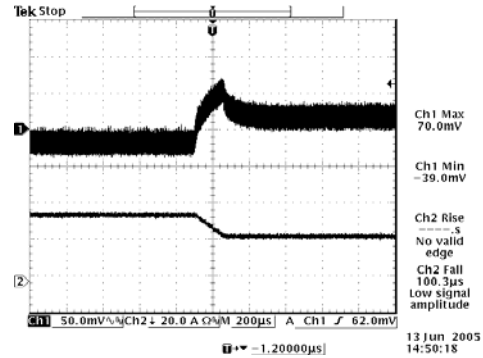

Vout= 1.2 V 75%-50% Load Transients

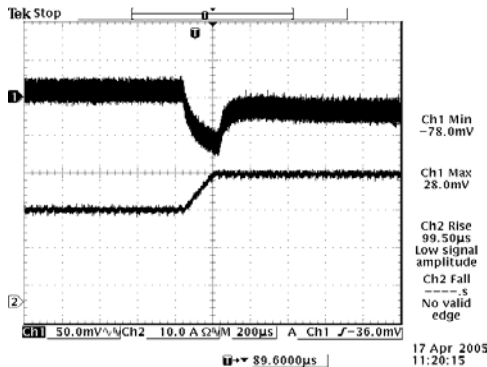

Vout= 1.5 V 50%-75% Load Transients

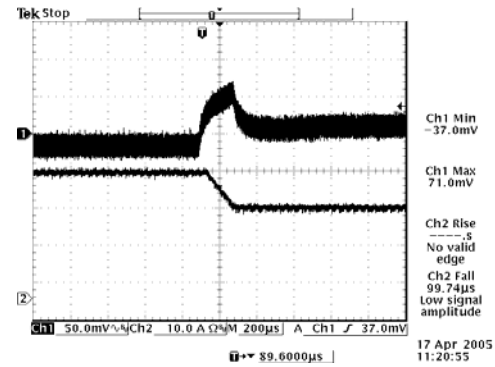

Vout= 1.5 V 75%-50% Load Transients

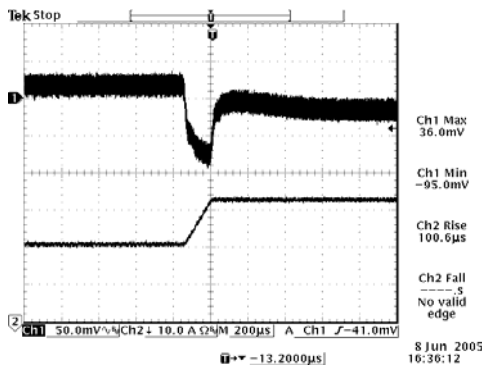

Vout= 1.8 V 50%-75% Load Transients

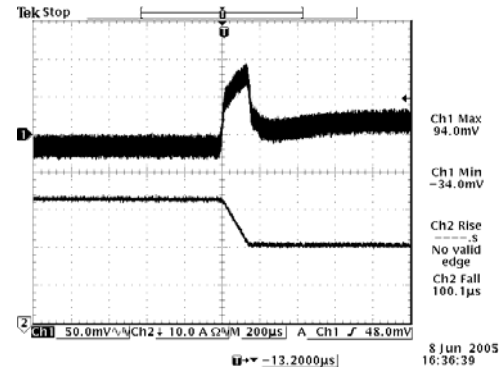

Vout= 1.8 V 75%-50% Load Transients

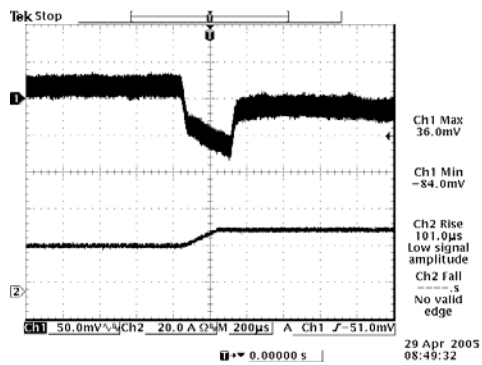

Vout= 2.5 V 50%-75% Load Transients

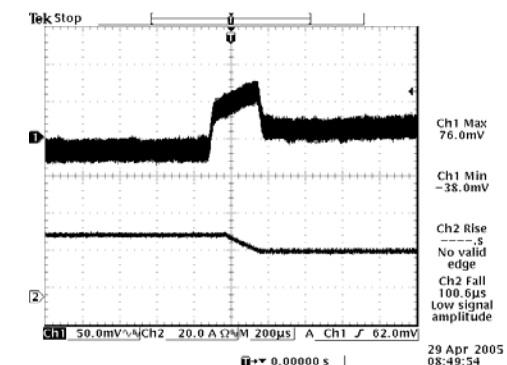

Vout= 2.5 V 75%-50% Load Transients

ISOLATED DC/DC CONVERTERS

48 Vdc Input 12 Vdc/12 A, 3.3 Vdc/46 A, 5 Vdc/30 A, 1.2-2.5 Vdc/50 A Outputs



Transient Response Waveforms (continued)

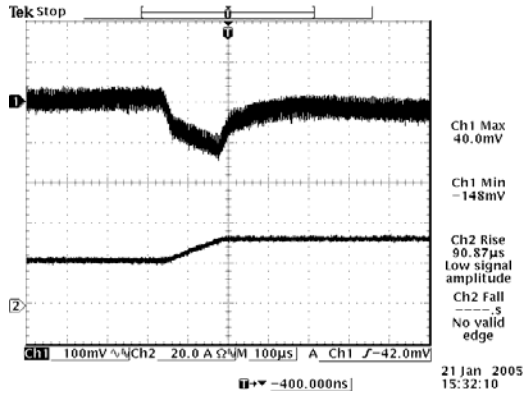

Vout= 3.3 V 50%-75% Load Transients

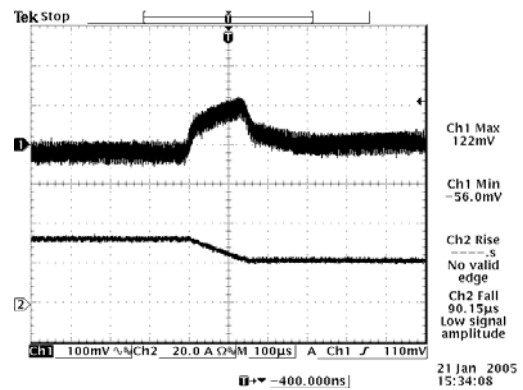

Vout= 3.3 V 75%-50% Load Transients

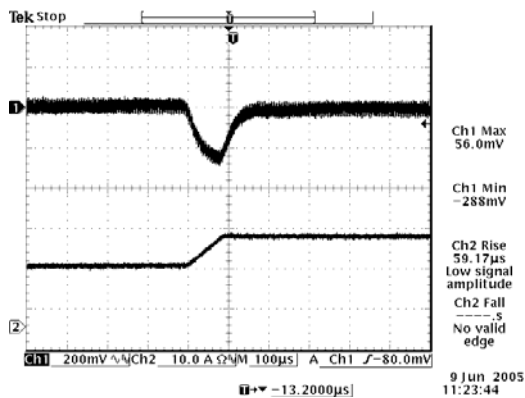

Vout= 5.0 V 50%-75% Load Transients

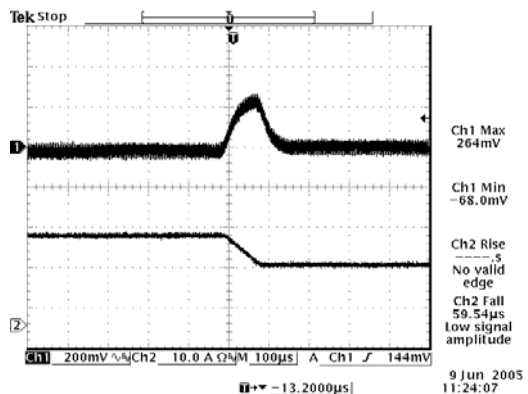

Vout= 5.0 V 75%-50% Load Transients

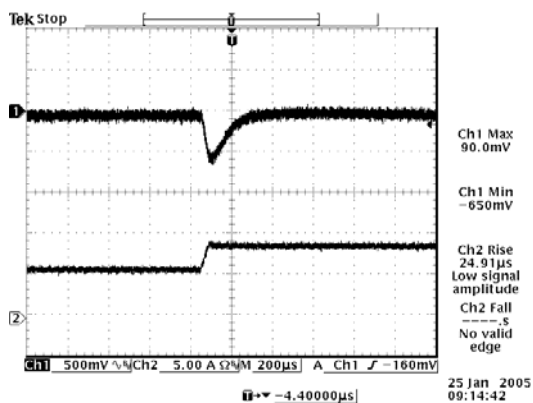

Vout= 12 V 50%-75% Load Transients

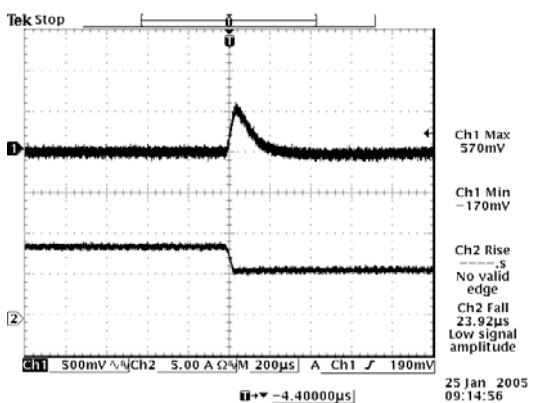

Vout= 12 V 75%-50% Load Transients

Note: Transient response at Vin=48 V, di/dt = 0.1 A/uS, with a 1 uF ceramic capacitor and a 10 uF Tantalum capacitor at the output, Ta=25 deg C.

ISOLATED DC/DC CONVERTERS

48 Vdc Input 12 Vdc/12 A, 3.3 Vdc/46 A, 5 Vdc/30 A, 1.2-2.5 Vdc/50 A utputs



Mechanical Outline

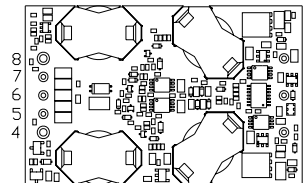
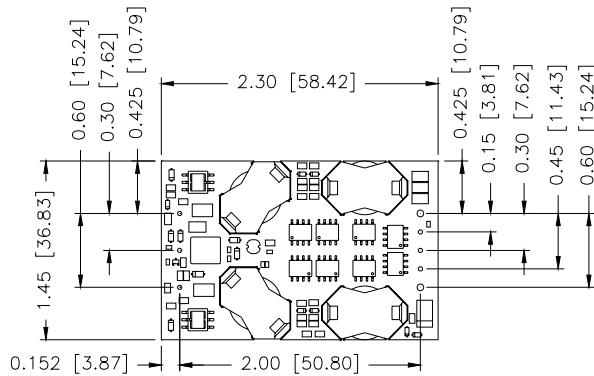

BOTTOM VIEW

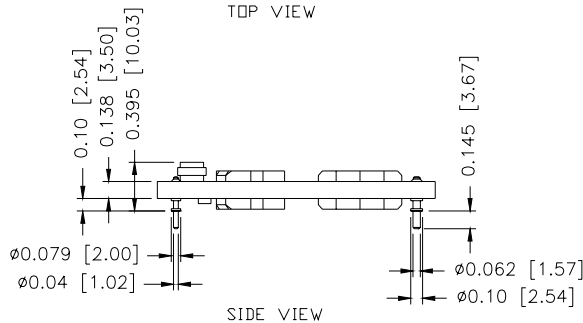

SIDE VIEW

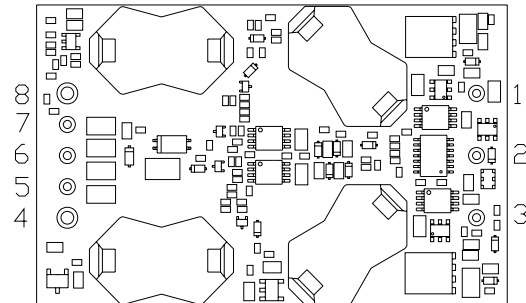

BOTTOM VIEW

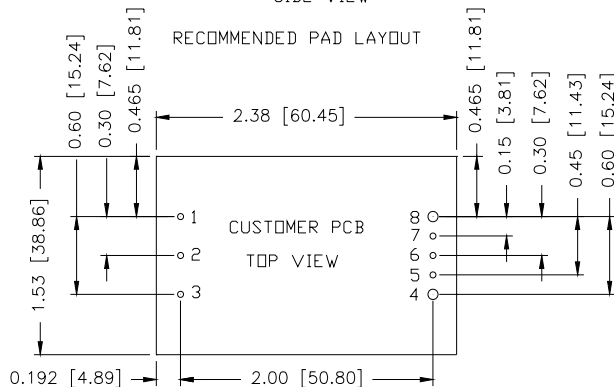

1,2,3,5,6,7 ϕ 0.047 HOLE SIZE, ϕ 0.08 min PAD SIZE
4,8 ϕ 0.07 HOLE SIZE, ϕ 0.10 min PAD SIZE

Pin Connections

| Pin | Function | Pin Size |
|-----|------------------|----------|
| 1 | Vin (+) | 0.04" |
| 2 | Remote On/Off | 0.04" |
| 3 | Vin (-) | 0.04" |
| 4 | Vout (-) | 0.062" |
| 5 | Remote Sense (-) | 0.04" |
| 6 | Trim | 0.04" |
| 7 | Remote Sense (+) | 0.04" |
| 8 | Vout (+) | 0.062" |

RoHS Compliance

Complies with the European Directive 2002/95/EC, calling for the elimination of lead and other hazardous substances from electronic products.



©2008 Bel Fuse Inc. Specifications subject to change without notice. 012508

CORPORATE

Bel Fuse Inc.
206 Van Vorst Street
Jersey City, NJ 07302
Tel 201-432-0463
Fax 201-432-9542
www.belfuse.com

FAR EAST

Bel Fuse Ltd.
8F/ 8 Luk Hop Street
San Po Kong
Kowloon, Hong Kong
Tel 852-2328-5515
Fax 852-2352-3706
www.belfuse.com

EUROPE

Bel Fuse Europe Ltd.
Preston Technology Management Centre
Marsh Lane, Suite G7, Preston
Lancashire, PR1 8UD, U.K.
Tel 44-1772-556601
Fax 44-1772-888366
www.belfuse.com