

# ORQB-30Y05L Series

## Isolated DC-DC Converter

The ORQB-30Y05L is an isolated DC/DC converter providing 30 W of output power from a wide input range (24 V, 48 V, 72 V, 96 V, 110 V typical). Standard features include remote on/off, input under-voltage protection, output over-voltage protection, over current and short circuit protection. This converter can also provide a 5 V/5 mA auxiliary supply. When a large hold-up capacitor is added, the converter can still work up to 12 ms when the input supply is interrupted. Conformal coated PCB is used for environmental ruggedness.



### Key Features & Benefits

- 24/48/72/96/110 VDC Input
- 5 VDC / 6 A Output
- Isolated
- Input under-voltage protection
- High Efficiency
- Output over-voltage protection
- Hold-up function
- Over current and short circuit protection
- Remote ON/OFF
- Over temperature protection
- Conformal coated
- 5V auxiliary supply at primary side
- Wide input range (24 V, 48 V, 72 V, 96 V, 110 V typical)
- Class II, Category 2, Isolated DC/DC Converter (refer to IPC-9592B)
- Approved to EN60950-1, 2nd +A2 version



### Applications

- Industrial
- Railway

## 1. MODEL SELECTION

OUTPUT VOLTAGE	INPUT VOLTAGE	MAX. OUTPUT CURRENT	MAX. OUTPUT POWER	TYPICAL EFFICIENCY	MODEL NUMBER ACTIVE LOW
5 VDC	24/48/72/96/110 VDC	6 A	30 W	82%	ORQB-30Y05L

**NOTE:** Add "G" suffix at the end of the model number to indicate Tray Packaging.

### PART NUMBER EXPLANATION

0	R	QB	-	30	Y	05	L	y
Mounting Type	RoHS Status	Series Name	Output Power	Input Range	Output Voltage	Active Logic & HSK Feature	Package Type	
Through hole mount	RoHS	DOSA Quarter Brick	30 W	24/48/72/96/110V	5 V	Active low, baseplate	G – Tray package	

## 2. ABSOLUTE MAXIMUM RATINGS

PARAMETER	DESCRIPTION	MIN	TYP	MAX	UNITS
Continuous non-operating Input Voltage		-0.5	-	160	V
Remote On/Off		-0.3	-	15	V
Thermal Resistance	Baseplate to heatsink, flat greased surface Baseplate to ambient	-	0.24 4		°C/W
Operating Temperature	Temperature measured at the center of the baseplate, full load	-40	-	105	°C
Storage Temperature		-55	-	125	°C
Altitude		-	-	2000	m

**NOTE:** Ratings used beyond the maximum ratings may cause a reliability degradation of the converter or may permanently damage the device.

## 3. INPUT SPECIFICATIONS

PARAMETER	DESCRIPTION	MIN	TYP	MAX	UNIT
Operating Input Voltage Range 1	Fully functioning for long term operation.	16.8	24 48 72 96 110	137.5	V
Operating Input Voltage Range 2	Fully functioning for 0.1s operation. Full function is not guaranteed but undamaged for 1s operation.	14.4 137.5	-	16.8 154	V
Input Current		-	-	3.0	A
Input Voltage Rising Slope		-	-	2	V/ms
Input Current (no load)		-	100	150	mA
Remote Off Input Current		-	-	40	mA
Input Reflected Ripple Current (pk-pk)	With simulated source impedance of 10 $\mu$ H, 5Hz to 20 MHz. Use two 100 $\mu$ F/250 V electrolytic capacitors with ESR=0.5R max, at 200 kHz @ 25°C.	-	-	300	mA
Input Reflected Ripple Current (rms)		-	-	100	mA
Under-voltage Turn on Threshold	Lockout turn on	14.5	15.2	16	V
Under-voltage Turn off Threshold	Lockout turn off, non-latching	12.5	13.2	14	V
Recommended input fast-acting fuse on system board	<b>CAUTION:</b> This converter is not internally fused. An input line fuse must be used in application.	-	6	-	V

## 4. OUTPUT SPECIFICATIONS

PARAMETER	DESCRIPTION	MIN	TYP	MAX	UNIT
Output Voltage Set Point		4.9	5	5.1	V
Line Regulation		-	-	10	mV
Load Regulation		-	-	20	mV
Regulation Over Temperature		-	-	±100	mV
Output Current Range		0	-	6	A
Output Ripple and Noise (pk-pk)	With a 100 µF ceramic and a 100 µF electrolytic capacitors at output.	-	50	80	mV
Output Ripple and Noise (rms)		-	10	15	mV
Output DC Current Limit	Enter a hiccup mode, non-latching.	7	-	10	A
Turn on Time	Enable from Vin	-	-	1500	ms
	Enable from ON/OFF	-	-	200	
Rise Time		-	25	50	
Overshoot at Turn on		-	0	3	%
Undershoot at Turn off		-	0	3	%
Output Capacitance	Typically 50% ceramic and 50% electrolytic capacitors.	200	-	1000	µF
5V Auxiliary Supply Source Current		-	-	5	mA
TRANSIENT RESPONSE					
ΔV 50% ~ 75% of Max Load		-	200	-	mV
Settling Time	di/dt = 0.1 A/µs, with a 100 µF ceramic and a 100 µF electrolytic capacitors near the brick output.	-	0.5	-	ms
ΔV 75% ~ 50% of Max Load			-	200	-
Settling Time		-	0.5	-	ms

**NOTE:** All specifications are typical at nominal input, full load at 25°C unless noted.

## 5. GENERAL SPECIFICATIONS

PARAMETER	DESCRIPTION	MIN	TYP	MAX	UNIT
Efficiency	Vin = 24 V, Iout = 6 A	81	82	-	%
	Vin = 48 V, Iout = 6 A	82	83	-	
	Vin = 72 V, Iout = 6 A	82	83	-	
	Vin = 96 V, Iout = 6 A	82	83	-	
	Vin = 110 V, Iout = 6 A	83	84	-	
Switching Frequency	1st stage	-	150	-	kHz
	2nd stage	-	250	-	
FIT*	Calculated Per IEC 62380 TR 1 (Utec 80-810)	-	176.66	-	-
MTBF*	(Vin=24 V, Vo=5V, Io=6A, Tac = 50°C, Tae=35°C)	-	5.66	-	Mil. hours
Over Temperature Protection		-	125	-	°C
Over Voltage Protection (Static)		-	6	-	
ISOLATION CHARACTERISTICS					
Isolation Capacitance		-	-	2200	pF
Isolation Resistance		10M	-	-	ohm
Input to Output		-	-	2250	V
Input to Heatsink		-	-	2250	
Output to Heatsink		-	-	2250	
Dimensions (L x W xH)			2.30 x1.45 x 0.59		inch
			62.24 x36.84 x15		mm
Weight		-	62	-	g

**NOTE:** All specifications are typical at 25 °C unless otherwise stated.



Asia-Pacific  
+86 755 298 85888

Europe, Middle East  
+353 61 225 977

North America  
+1 408 785 5200

## 6. EFFICIENCY DATA

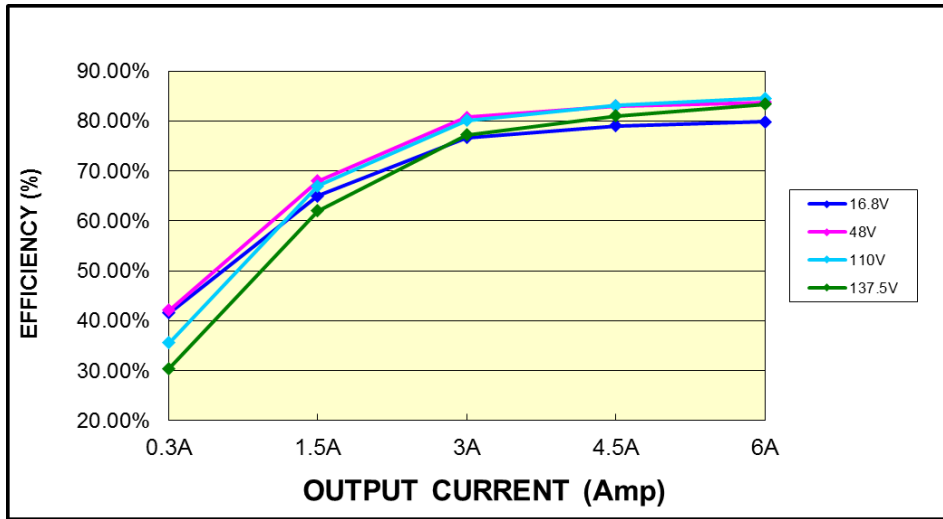

## 7. THERMAL DERATING CURVES

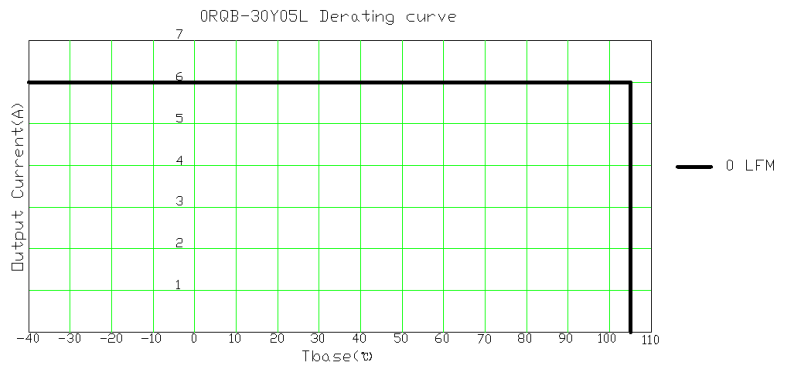
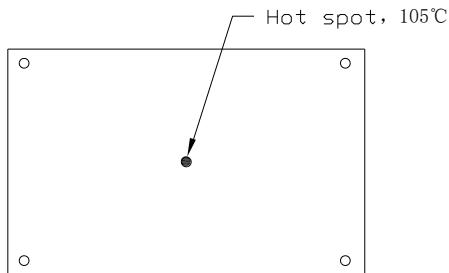
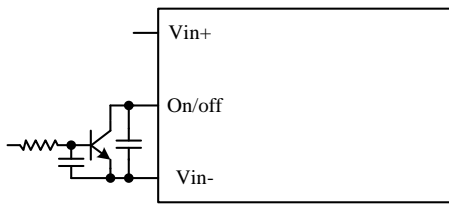

Figure 1. Module top view

## 8. REMOVE ON/OFF

PARAMETER	DESCRIPTION	MIN	TYP	MAX	UNIT
<b>REMOTE ON/OFF</b>					
Signal Low (Unit On)	Active Low	-0.3	-	0.8	V
Signal High (Unit Off)		2.4	-	15	V
Current Sink		0	-	1	mA

### Recommended Remote On/Off Circuit for Active Low



Control with open collector/drain circuit

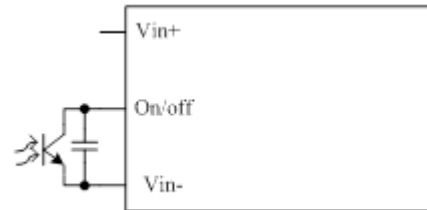

Control with coupler circuit

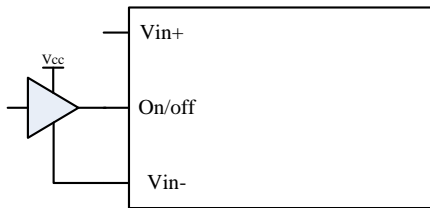

Control with logic circuit



Permanently on

## 9. INPUT UNDER-VOLTAGE LOCKOUT

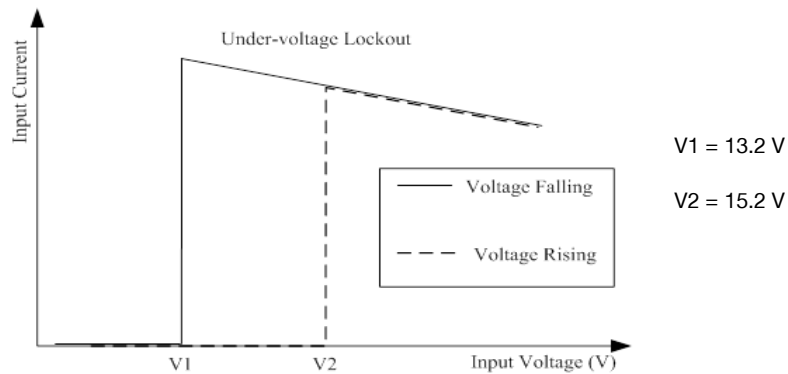

10. INPUT NOISE

Input Reflected Ripple Current

Testing set up

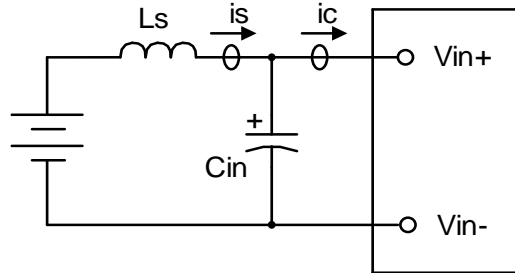

Notes and values in testing.

- is*: Input Reflected Ripple Current
- ic*: Input Terminal Ripple Current
- Ls*: Simulated Source Impedance (10μH)
- Cin*: Electrolytic capacitor, should be as closed as possible to the power module to swallow *ic* ripple current and help with stability. Recommendation: 2\* 100μF, ESR<0.5R @ 100 kHz, 20C

Below measured waveforms are based on above simulated and recommended inductance and capacitance

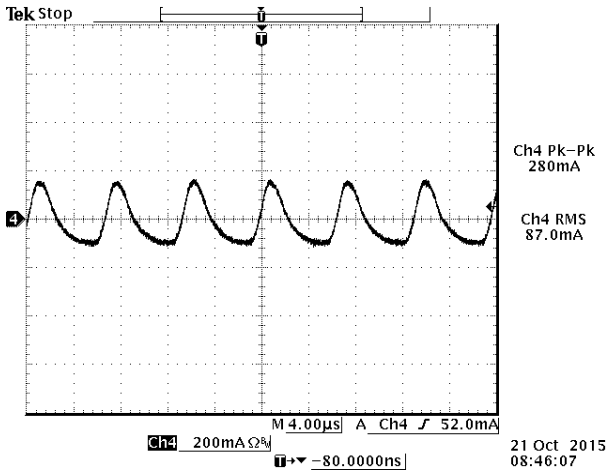

Figure 2. *is* (input reflected ripple current), AC component

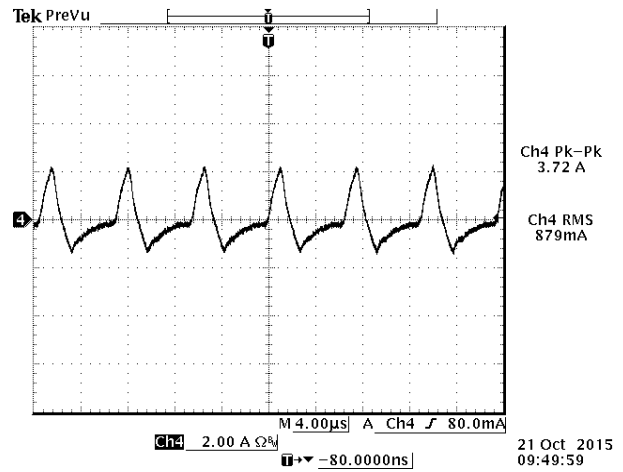
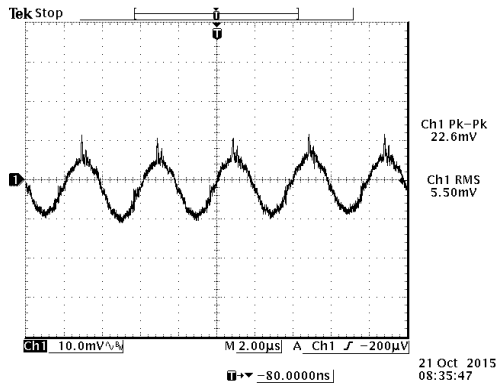

Figure 3. *ic* (input reflected ripple current), AC component

**NOTE:** 48 VDC input, 5 VDC/6A output and Ta=25 °C, with 100μF ceramic capacitor and 100μF AL. cap at output.

## 11. RIPPLE AND NOISE WAVEFORM



**NOTE:** Ripple & noise at full load, 48 V input, with a 1<sup>st</sup> F ceramic capacitor and a 10 µF tantalum capacitor at the output, and Ta=25°C.

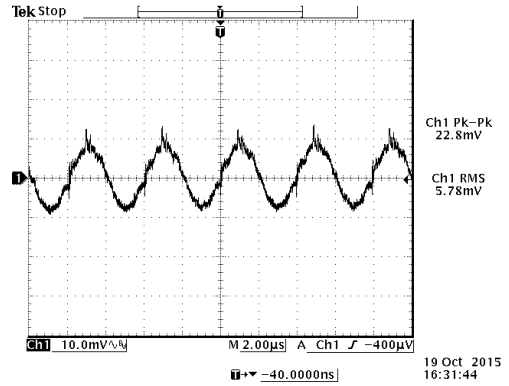

**NOTE:** Ripple and noise, 110VDC input, 5VDC/6A output and Ta=25 °C, with 100µF ceramic capacitor and 100µF AL. cap at output.

## 12. TRANSIENT RESPONSE

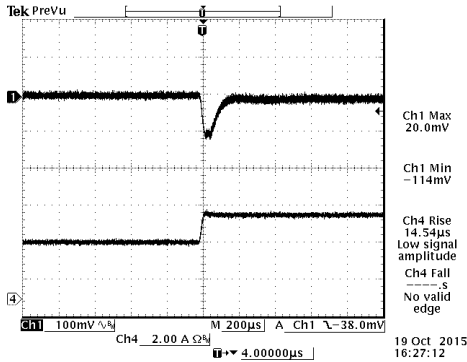

Figure 4. 50%-75% Load Transients at Vin=48V@Ta=25°C

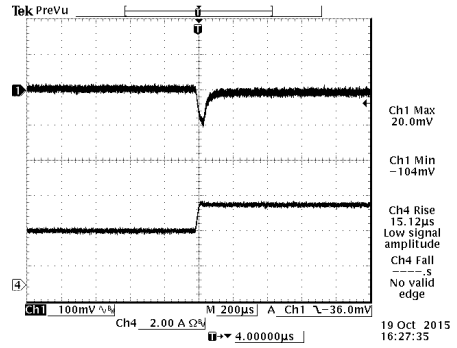

Figure 5. 50%-75% Load Transients at Vin=110V@Ta=25°C

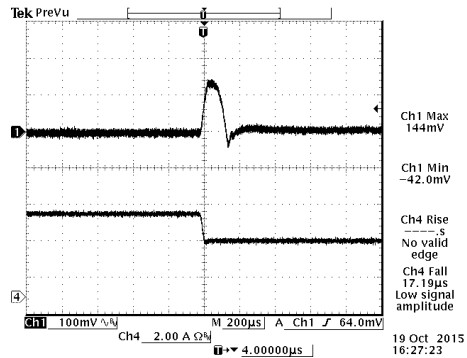

Figure 6. 75%-50% Load Transients at Vin=48V@Ta=25°C

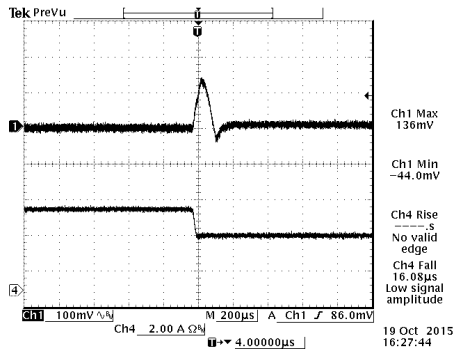

Figure 7. 75%-50% Load Transients at Vin=110V@Ta=25°C



Asia-Pacific  
+86 755 298 85888

Europe, Middle East  
+353 61 225 977

North America  
+1 408 785 5200

### 13. STARTUP & SHUTDOWN

#### TURN ON RISE TIME

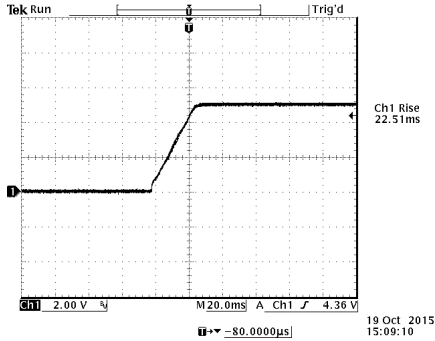

Figure 8.  $V_{in}=48V, I_o=6A, V_o=5$

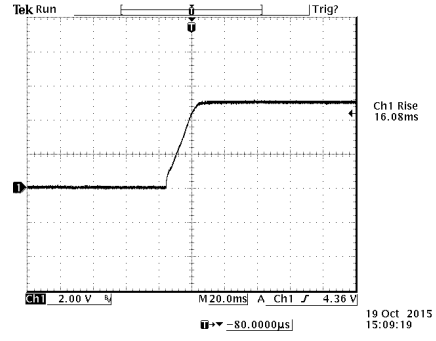

Figure 9.  $V_{in}=110V, I_o=6A, V_o=5V$

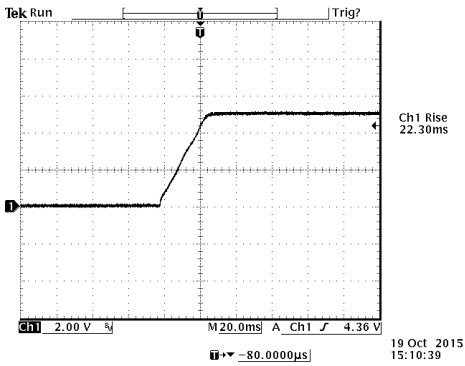

Figure 10.  $V_{in}=48V, I_o=6A, V_o=5V$ , with  $C_{ext}=1000\mu F$

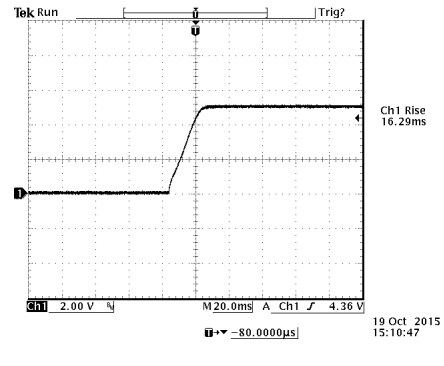

Figure 11.  $V_{in}=48V, I_o=6A, V_o=5V$ , with  $C_{ext}=1000\mu F$

#### TURN ON DELAY TIME

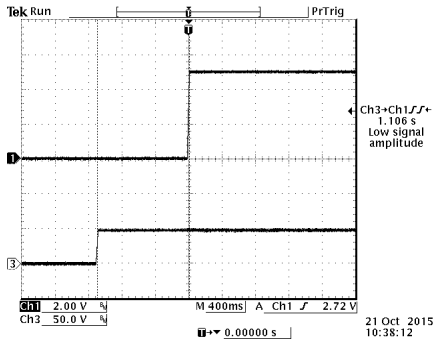

Figure 12. Startup from  $V_{in}$   
Ch1:  $V_o$   
Ch3:  $V_{in}$   
 $V_{in}=48V, I_o=6A, V_o=5V$

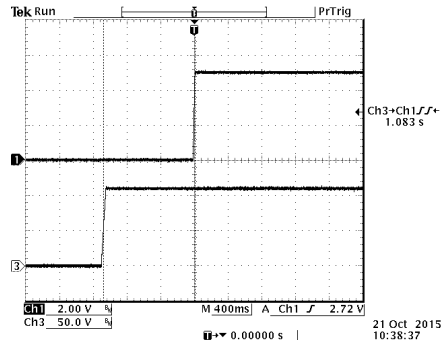

Figure 13. Startup from  $V_{in}$   
Ch1:  $V_o$   
Ch3:  $V_{in}$   
 $V_{in}=110V, I_o=6A, V_o=5V$



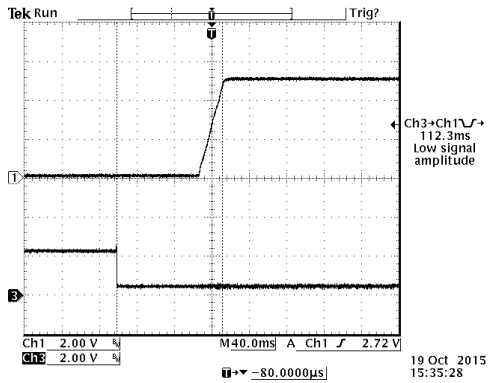

Figure 14. Startup from on/off  
 Ch1: Vo  
 Ch3: on/off  
 Vin=48V, Io=6A, Vo=5V

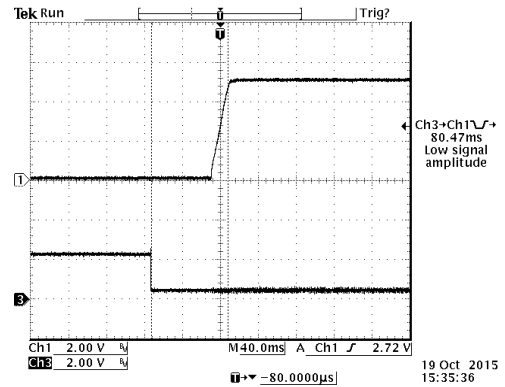

Figure 15. Startup from on/off  
 Ch1: Vo  
 Ch3: on/off  
 Vin=110V, Io=6A, Vo=5V

## SHUTDOWN

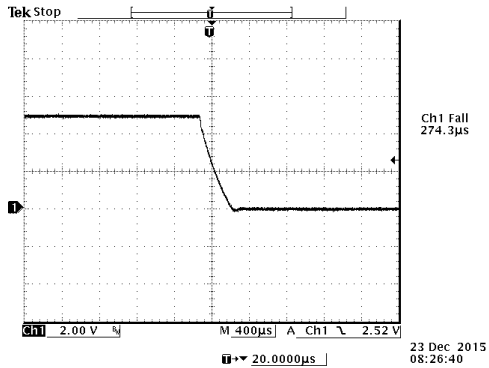

Figure 16. Vin=48V, Io=6A, Vo=5

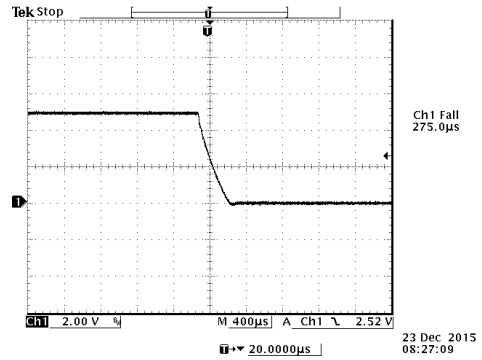

Figure 17. Vin=48V, Io=6A, Vo=5

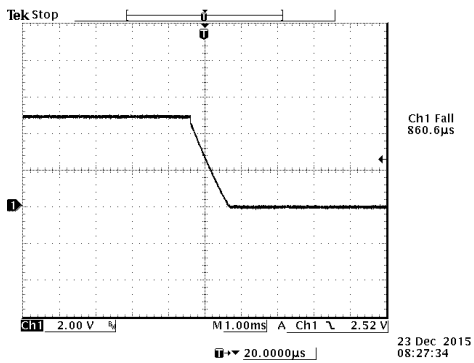

Figure 18. Vin=48V, Io=6A, Vo=5, with Cext=1000µF

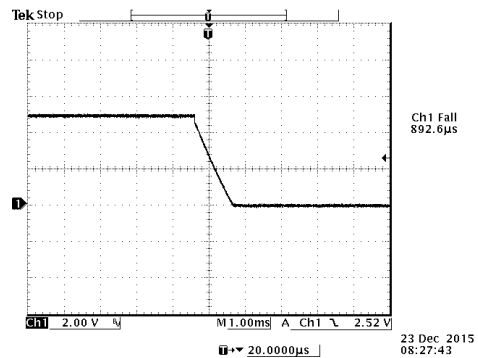
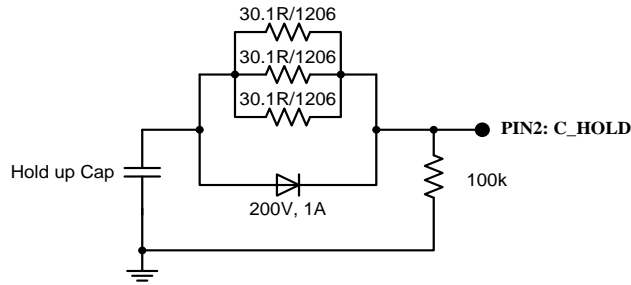

Figure 19. Vin=48V, Io=6A, Vo=5, with Cext=1000µF

### 14. HOLD UP CIRCUIT

PARAMETER	DESCRIPTION	SYMBOL	MIN	TYP	MAX	UNITS
Hold up Capacitor	Working voltage rating should be 200V. Caution: This capacitor is necessary for both normal and hold up operation.	C_HOLD	220	-	330	μF
Hold up Voltage	Normal operation.	V_HOLD	45	85	154	V
Hold up Time	16.8-137.5V input and all lout range.	T_HOLD	12	-	-	ms

#### Recommended External Hold up Circuit



### 15. SAFETY & EMC

#### SAFETY:

TUV certificated to EN60950-1, 2nd edition+ A2 version  
CE certificated to Low Voltage Directive 2014/35/EU

#### EMC:

Conductive EMI: EN55022 class A

Compliance to EN55022 class A (both peak and average) with the following inductive and capacitive filter

#### SETUP:

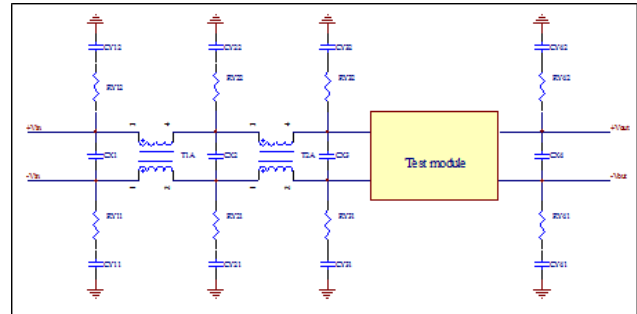

ITEM	DESIGNATOR	PARAMETER	VENDOR	VENDOR P/N
1	CX1	100μF/200V, AL cap		
2	CX2	220μF/200V, AL cap		
2	CX3	220μF/200V, AL cap		
3	CX4	220μF/200V, AL cap		
3	CY21	0.22μF/1000V, ceramic		
4	CY22	0.22μF/1000V, ceramic		
7	RY21	1206,0 R, Resistor		
8	RY22	1206,0 R, Resistor		
11	T2A	0.45mH, common mode		
12	T1A	0.9mH, common mode		
12	RY11,RY12,CY11,CY21, RY31,RY32,CY31,CY32 RY41,RY42,CY41,CY42	NIL		

### POSITIVE:

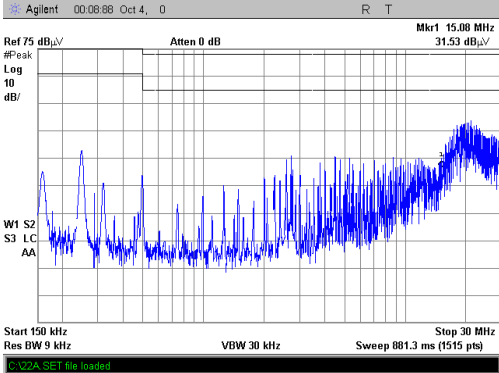

### NEGATIVE:

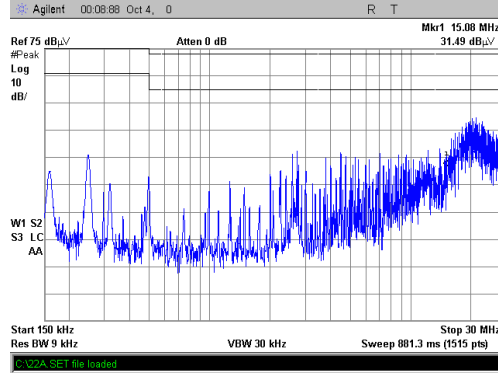

Asia-Pacific  
+86 755 298 85888

Europe, Middle East  
+353 61 225 977

North America  
+1 408 785 5200

16. MECHANICAL OUTLINE

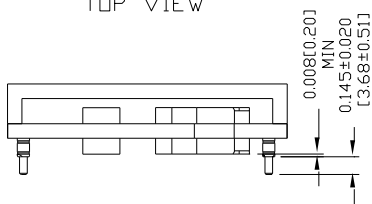
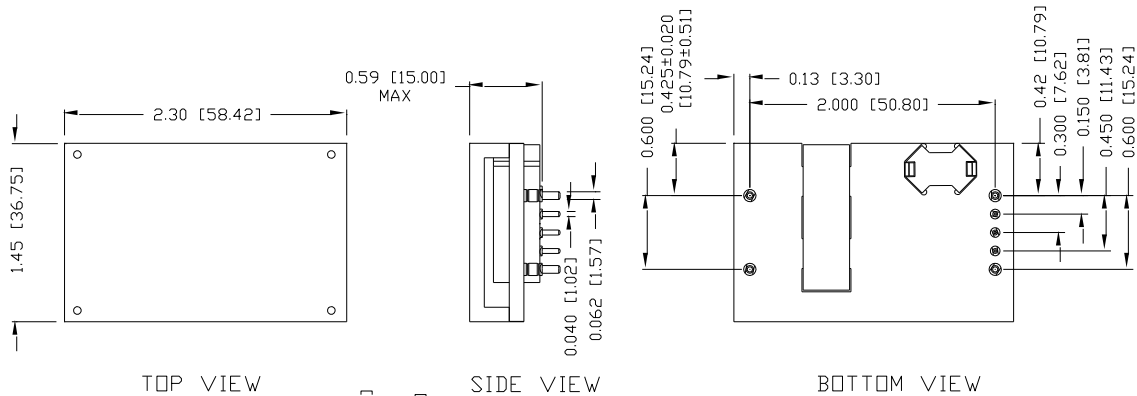

UNIT:INCH[MM]

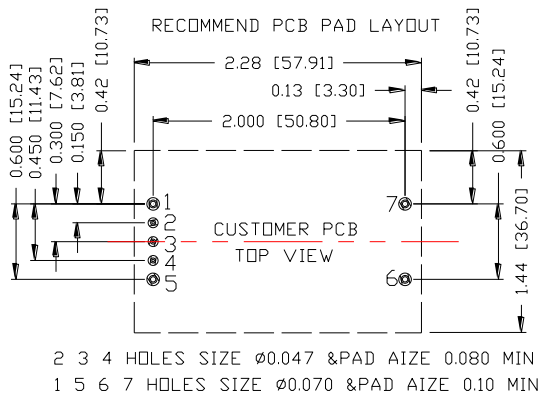
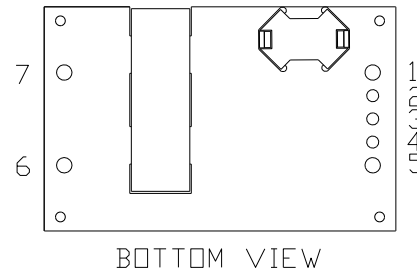

PIN CONNECTIONS

PIN	FUNCTION
1	Vin(+)
2	C_HOLD
3	ON/OFF
4	V_AUX(5V)
5	Vin(-)
6	Vout(-)
7	Vout(+)

**NOTE:** This module is recommended and compatible with Pb-Free Wave Soldering and must be soldered using a peak solder temperature of no more than 260 °C for less than 5 seconds.

**NOTE:** 1) All Pins: Material - Copper Alloy;  
Finish - Tin plated

2) Undimensioned components are shown for visual reference only.

3) All dimensions in inches (mm); Tolerances: x.xx +/-0.02 in. (x.x +/-0.5mm) x.xxx +/-0.010 in. (x.xx +/-0.25mm).

## 17. REVISION HISTORY

DATE	REVISION	CHANGES DETAIL	APPROVAL
2014-11-12	A	First release	Summer Wang
2015-12-23	B	1. Update rise time and turn on time 2. Update Efficiency value 3. Update waveform of electrical performance	Summer Wang
2016-02-26	C	1. Change the operation temperature in Absolute Maximum Ratings 2. Add thermal resistance in Absolute Maximum Ratings	Summer Wang
2016-04-21	D	Update Safety Certification, MTBF, Thermal Derating Curve, MD.	Summer Wang

**For more information on these products consult: [tech.support@psbel.com](mailto:tech.support@psbel.com)**

**NUCLEAR AND MEDICAL APPLICATIONS** - Products are not designed or intended for use as critical components in life support systems, equipment used in hazardous environments, or nuclear control systems.

**TECHNICAL REVISIONS** - The appearance of products, including safety agency certifications pictured on labels, may change depending on the date manufactured. Specifications are subject to change without notice.



**Asia-Pacific**  
+86 755 298 85888

**Europe, Middle East**  
+353 61 225 977

**North America**  
+1 408 785 5200