

IEC Appliance Inlet C14 with Filter, "Lock and Shield" Mounting



GRF4: with shield and line filter



See below:
[Approvals and Compliances](#)

Description

- Panel mount :
 Snap-in version from rear-side
- 3 Functions :
 Appliance Inlet Protection class I , with EMC-shield , Line filter in standard and medical version

Characteristics

- Time saving "Lock and Shield" snap-in design for rear-panel mounting
- All single elements are already wired
- Innovative EMC-shielding with flexible steel segments for an excellent contact to the panel
- Suitable for use in medical equipment according to IEC/UL 60601-1
 For applications according IEC/UL 62368-1 we recommend variants with bleed resistor

Other versions on request

- Panel thickness 1.2 mm and 2.0 mm

References

- Alternative: version without line filter [GRF2](#)
- Alternative: Standard version

Weblinks

- [pdf data sheet](#), [html datasheet](#), [General Product Information](#), [Approvals](#), [Distributor-Stock-Check](#), [Accessories](#), [Detailed request for product](#)

Technical Data

Ratings IEC	0.5 - 10A @ Ta 40 °C / 250VAC; 50Hz	Appliance inlet/-outlet	C14 acc. to IEC 60320-1, UL 60320-1, CSA C22.2 no. 60320-1 (for cold conditions) pin-temperature 70 °C, 10A, Protection Class I
Ratings UL/CSA	0.5 - 15A @ Ta 40 °C / 250VAC; 60Hz	Line Filter	Standard and Medical Version, IEC 60939, UL 1283, CSA C22.2 no. 8 Technical Details
Leakage Current	standard < 0.5mA (250V / 60Hz) medical < 5 µA (250 V / 60 Hz)	MTBF	> 3'300'000h acc. to MIL-HB-217 F
Dielectric Strength	> 1.7kVDC between L-N > 2.7kVDC between L/N-PE Test voltage (2 sec)		
Allowable Operation Temperature	-25 °C to 85 °C		
Climatic Category	25/085/21 acc. to IEC 60068-1		
IP-Protection	from front side IP40 acc. to IEC 60529		
Protection Class	Suitable for appliances with protection class I acc. to IEC 61140		
Terminal	Quick connect terminals 4.8 x 0.8 mm		
Panel Thickness S	Screw Mounting screw torque max 0.5Nm Snap-in: 1.5 mm (other on request)		
Material: Housing	Thermoplastic, black, UL 94V-0		

Approvals and Compliances



Detailed information on product approvals, code requirements, usage instructions and detailed test conditions can be looked up in [Details about Approvals](#)

SCHURTER products are designed for use in industrial environments. They have approvals from independent testing bodies according to national and international standards. Products with specific characteristics and requirements such as required in the automotive sector according to IATF 16949, medical technology according to ISO 13485 or in the aerospace industry can be offered exclusively with customer-specific, individual agreements by SCHURTER.

Approvals







The approval mark is used by the testing authorities to certify compliance with the safety requirements placed on electronic products.

Approval Reference Type: GRF4

Approval Logo	Certificates	Certification Body	Description
	VDE Approvals	VDE	VDE Certificate Number: 102348
	UL Approvals	UL	UL File Number: E72928

Product standards

Product standards that are referenced

Organization	Design	Standard	Description
	Designed according to	IEC 60320-1	Appliance couplers for household and similar general purposes
	Designed according to	IEC 60939	Passive filters for suppressing electromagnetic interference
	Designed according to	IEC 61058-1	Switches for appliances. Part 1. General requirements
	Designed according to	UL 60320-1	Standard for Attachment Plugs and Receptacles
	Designed according to	UL 1283	Electromagnetic interference filters
	Designed according to	CSA C22.2 no. 60320-1	General Use Receptacles, Attachment Plugs, and Similar Wiring Devices
	Designed according to	CSA C22.2 no. 8	Electromagnetic interference (EMI) filters





Application standards

Application standards where the product can be used

Organization	Design	Standard	Description
	Designed for applications acc.	IEC/UL 62368-1	IEC 62368-1 includes the basic requirements for safety of audio, video, information technology and office equipment.
	Designed for applications acc.	IEC 60601-1	Medical electrical equipment - Part 1: General requirements for basic safety and essential performance

Compliances

The product complies with following Guide Lines

Identification	Details	Initiator	Description
	CE declaration of conformity	SCHURTER AG	The CE marking declares that the product complies with the applicable requirements laid down in the harmonisation of Community legislation on its affixing in accordance with EU Regulation 765/2008.
	RoHS	SCHURTER AG	Directive RoHS 2011/65/EU, Amendment (EU) 2015/863
	China RoHS	SCHURTER AG	The law SJ / T 11363-2006 (China RoHS) has been in force since 1 March 2007. It is similar to the EU directive RoHS.
	REACH	SCHURTER AG	On 1 June 2007, Regulation (EC) No 1907/2006 on the Registration, Evaluation, Authorization and Restriction of Chemicals 1 (abbreviated as "REACH") entered into force.
	Medical Technology	SCHURTER AG	Suitable for use in medical equipment according to IEC/UL 60601-1

Dimension [mm]

GRF4

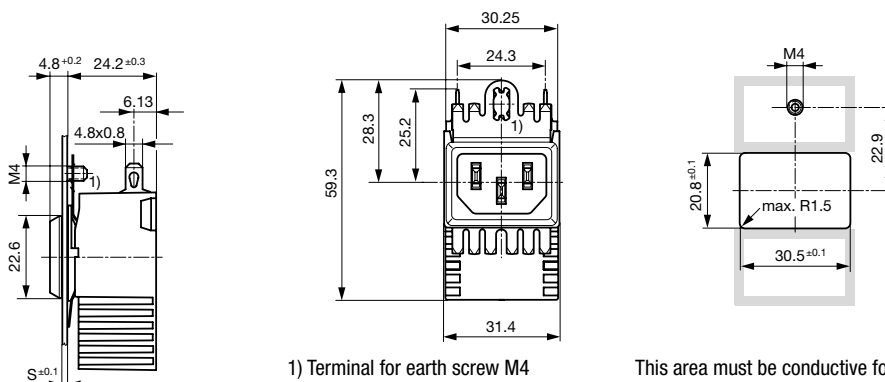

This area must be conductive for optimal shielding. Do not apply paint or coatings.

Assembly Instructions

Step 1

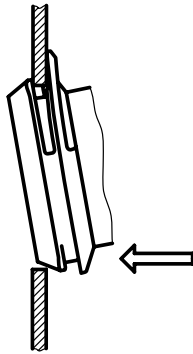

Place the socket in top edge of the panel cut-out.

Step 3

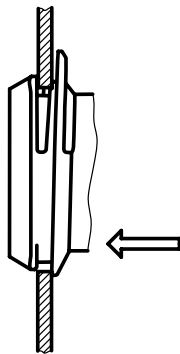

Push the socket forward into the panel cut-out.

Step 2

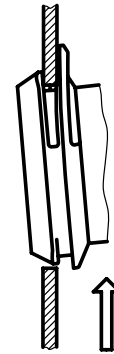

Push the socket upwards.

Step 4

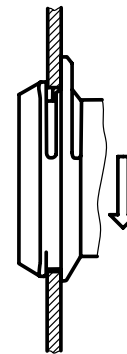

Release the socket. The component is self adjusting.

Technical Data of Filter-Components

Rated Current [A]	Filter-Type	Inductances L [mH]	Capacitance CX [nF]	Capacitance CY [nF]	R [MΩ]
0.5	Standard version	2 x 24	100	2.2	-
1	Standard version	2 x 12	100	2.2	-
3	Standard version	2 x 2.5	100	2.2	-
6	Standard version	2 x 0.78	100	2.2	-
10	Standard version	2 x 0.225	100	2.2	-
15	Standard version	2 x 0.1	100	2.2	-
0.5	Medical Version (M5)	2 x 24	100	-	1
1	Medical Version (M5)	2 x 12	100	-	1
3	Medical Version (M5)	2 x 2.5	100	-	1
6	Medical Version (M5)	2 x 0.78	100	-	1
10	Medical Version (M5)	2 x 0.225	100	-	1
15	Medical Version (M5)	2 x 0.1	100	-	1

Diagrams

Standard version

Medical Version (M5)

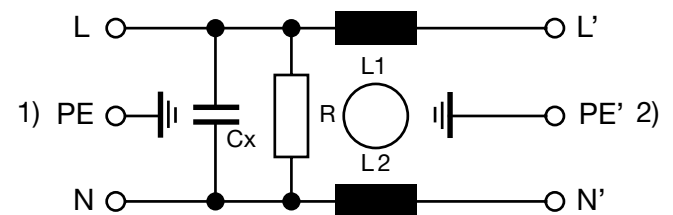
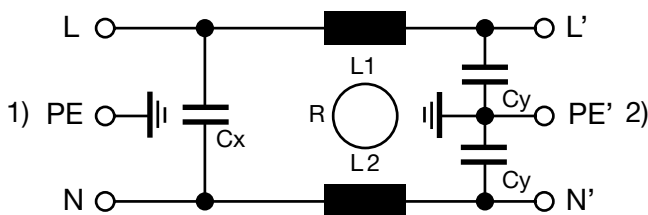

1) Line
2) Load

1) Line
2) Load

Attenuation Loss

--- 50Ω differential mode ___ 50Ω common mode

Standard version

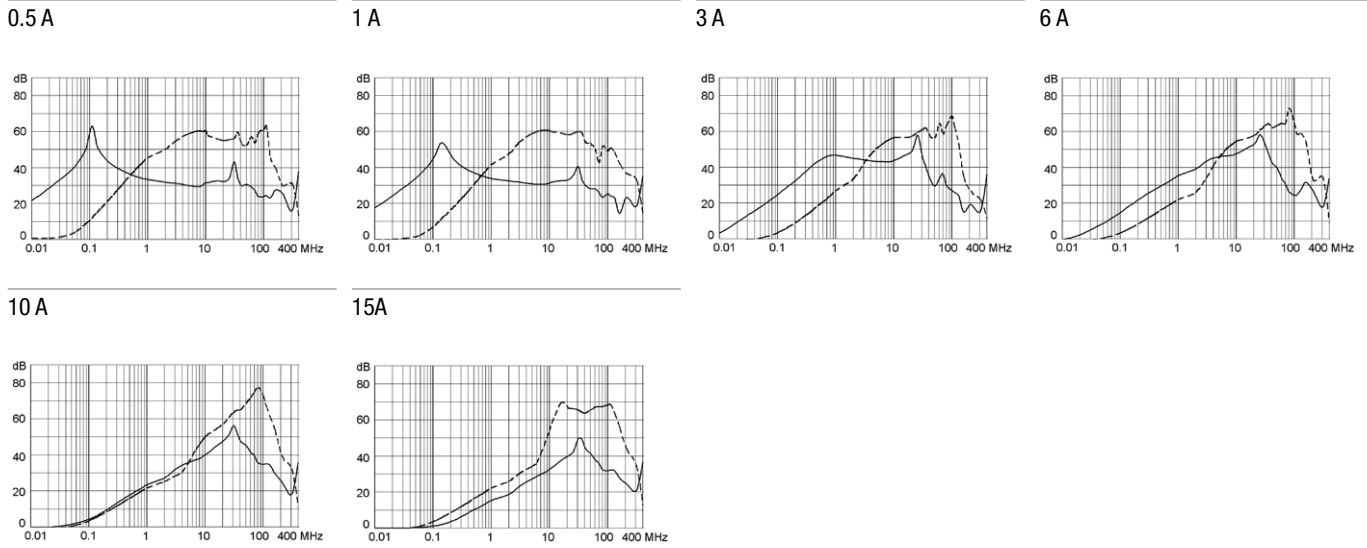

Medical version (M5)

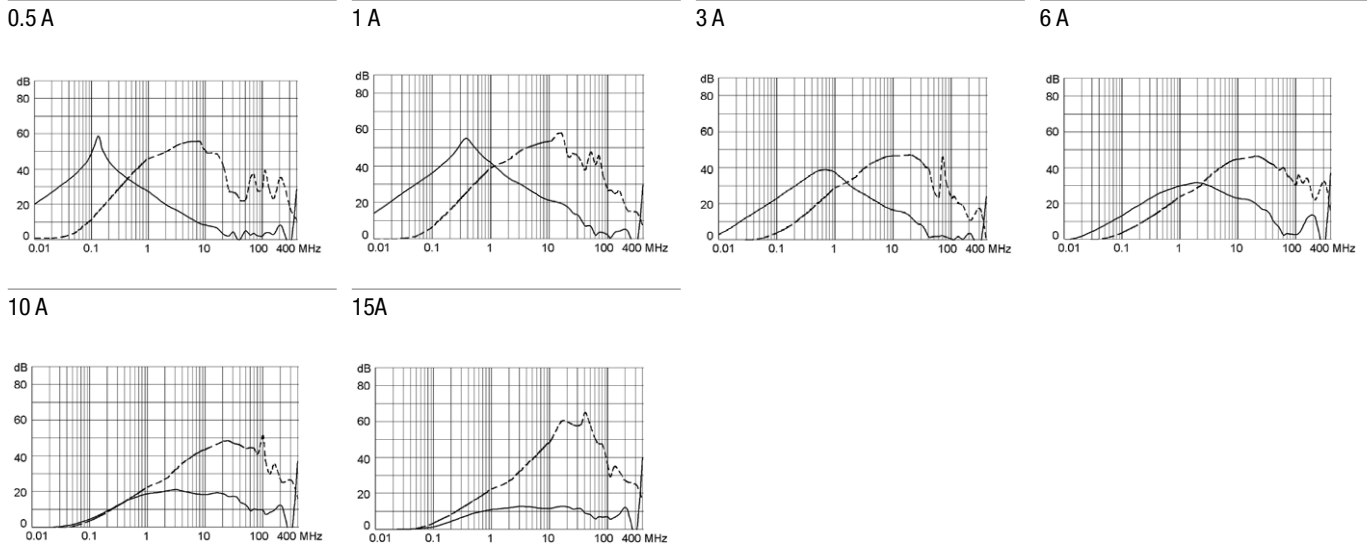

All Variants

Rated Current IEC [A]	Rated Current UL [A]	Filter-Type	Panel Thickness s [mm]	Packaging unit	Order Number
0.5	0.5	Standard version	1	20	GRF4.0411.011.C
1	1	Standard version	1	20	GRF4.0412.011.C
6	6	Standard version	1	20	GRF4.0416.011.C
10	10	Standard version	1	20	GRF4.0417.011.C
0.5	0.5	Standard version	1.5	20	GRF4.0411.013.C
1	1	Standard version	1.5	20	GRF4.0412.013.C
3	3	Standard version	1.5	20	GRF4.0413.013.C
6	6	Standard version	1.5	20	GRF4.0416.013.C
10	10	Standard version	1.5	20	GRF4.0417.013.C
15	15	Standard version	1.5	20	GRF4.0419.013.C
3	3	Standard version	2	20	GRF4.0413.014.C
0.5	0.5	Medical Version (M5)	1.5	20	GRF4.0021.013.C
1	1	Medical Version (M5)	1.5	20	GRF4.0022.013.C

Rated Current IEC [A]	Rated Current UL [A]	Filter-Type	Panel Thickness [mm]	Packaging unit	Order Number
3	3	Medical Version (M5)	1.5	20	GRF4.0023.013.C
6	6	Medical Version (M5)	1.5	20	GRF4.0026.013.C
10	10	Medical Version (M5)	1.5	20	GRF4.0027.013.C
15	15	Medical Version (M5)	1.5	20	GRF4.0029.013.C

Most Popular.

Availability for all products can be searched real-time: <https://www.schurter.com/en/Stock-Check/Stock-Check-SCHURTER>

Packaging unit 20 Pcs

Mating Outlets/Connectors

Category / Description

[Appliance Outlet Overview complete](#)



4787, Mounting: Screw-on mounting, Appliance Outlet: IEC Solder terminals, 10 A, Suitable for appliances with protection class I	4787
4788, Mounting: Snap-in version, Appliance Outlet: IEC Solder terminals or quick connect terminals, 10 A, Suitable for appliances with protection class I	4788
IEC Appliance Outlet F or H, Screw-on Mounting, Front Side, Solder, PCB or Quick-connect Terminal	5091

[Appliance Outlet further types to GRF4](#)

[Connector Overview complete](#)



4782 Mounting: Power Cord, 3 x 1 mm ² / 3 x 18 AWG, Cable, Connector: IEC C13	4782
4785 Mounting: Power Cord, 3 x 1 mm ² / 3 x 18 AWG, Cable, Connector: IEC C13	4785
4012 Mounting: Power Supply Cord, 3 x 1 mm ² , Screw clamps, Connector: IEC C13	4012
4300-06 Mounting: Power Cord, 3 x 1 mm ² / 3 x 18 AWG, Cable, Connector: IEC C13	4300-06
4781 Mounting: Power Cord, 3 x 1 mm ² / 3 x 18 AWG, Cable, Connector: IEC C15	4781

[Connector further types to GRF4](#)

...