

DrMOS Integrated Power Stage

DESCRIPTION

The SiC770 is an integrated power stage solution optimized for synchronous buck applications to offer high current, high efficiency and high power density performance. Packaged in Vishay's proprietary 6 mm x 6 mm MLP package, SiC770 enables voltage regulator design to deliver in excess of 40 A per phase current.

The internal power MOSFETs utilizes Vishay's state-of-the-art TrenchFET Gen IV technology that delivers industry bench-mark performance to significantly reduce switching and conduction losses.

The SiC770 incorporates an advanced MOSFET gate driver IC that features high current driving capability, adaptive dead-time control, and integrated bootstrap Schottky diode, a thermal warning (THWn) alerts the system of excessive junction temperature. This driver is also compatible with wide range of PWM controllers with the support of tri-state PWM, 5 V PWM logic, and skip mode (ZCD) for improve light load efficiency.

FEATURES

- Industry benchmark MOSFET with integrated Schottky diode
- Delivers in excess of 40 A continuous current
- 91 % peak efficiency
- High frequency operation up to 1 MHz
- Power MOSFETs optimized for 19 V input stage
- 5 V PWM logic with tri-state and hold-off
- Automatic skip mode operation (ZCD) for light load efficiency
- Built-in bootstrap Schottky diode
- Thermal monitor flag
- V_{CIN} under voltage lockout
- Compliant with Intel DrMOS 4.0 specification
- Thermally enhanced PowerPAK® MLP6x6-40L package
- Material categorization: For definitions of compliance please see www.vishay.com/doc?99912



RoHS
COMPLIANT
HALOGEN
FREE

APPLICATIONS

- Synchronous buck converters
- Multi-phase VRDs for CPU, GPU and memory
- DC/DC POL modules

TYPICAL APPLICATION DIAGRAM

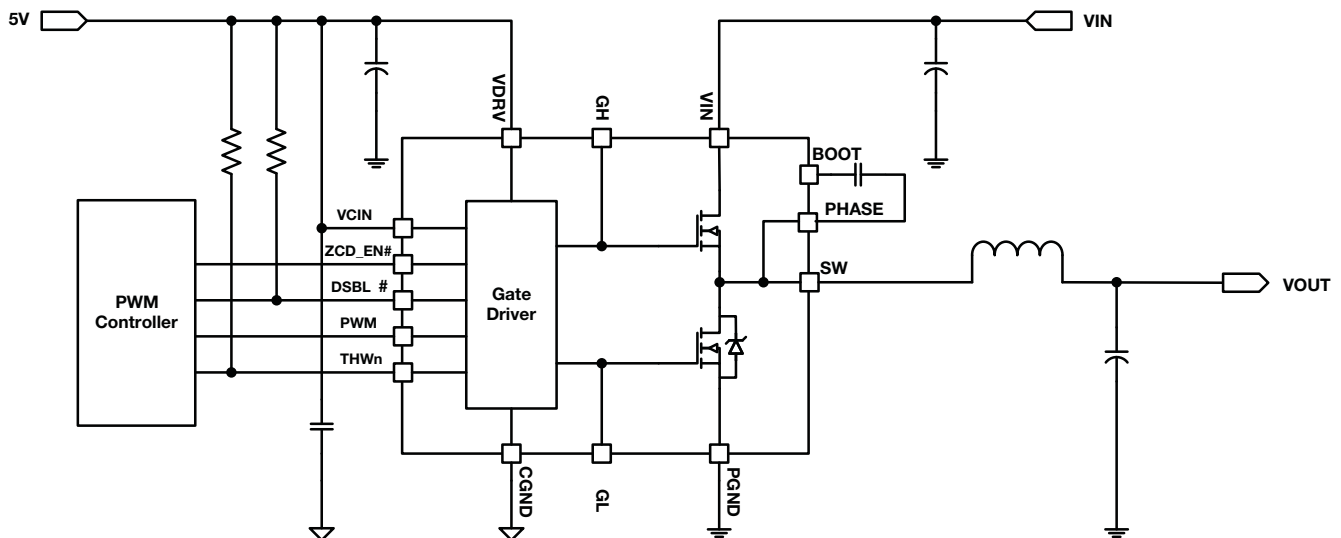

Fig. 1 - SiC770 Typical Application Diagram

PINOUT CONFIGURATION

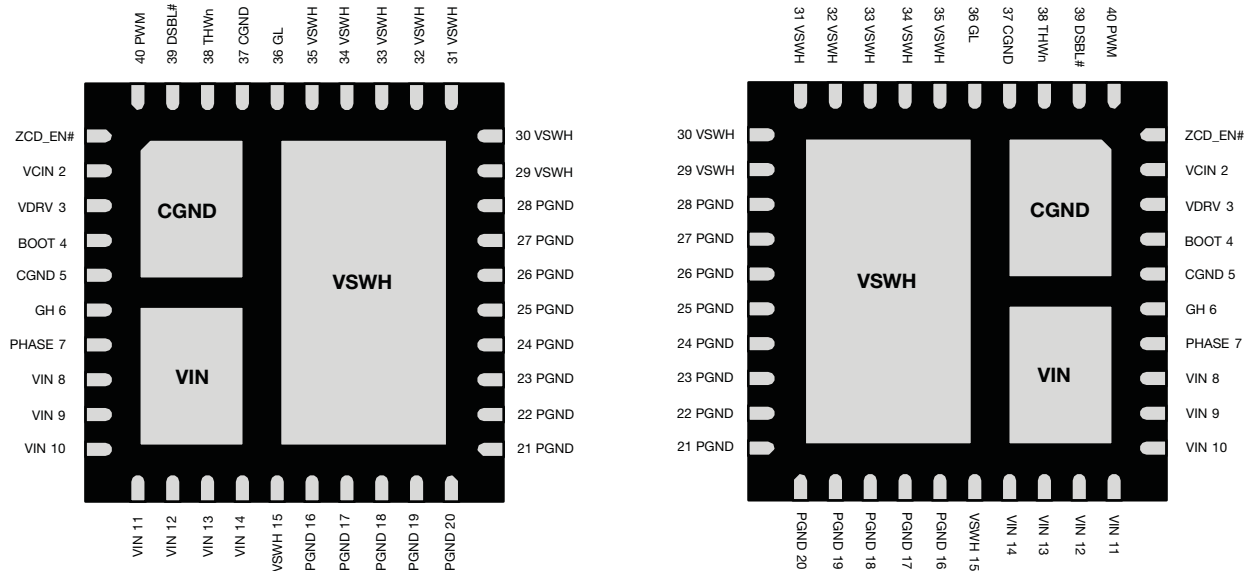

Fig. 2 - SiC770 Pin Configuration

PIN DESCRIPTION		
PIN#	NAME	FUNCTION
1	ZCD_EN#	LS FET turn-off logic; active low
2	V _{CIN}	Supply voltage for internal logic circuitry
3	V _{DRV}	Supply voltage for internal gate driver
4	BOOT	High side driver bootstrap voltage
5, 37, P1	C _{GND}	Analog ground for the driver IC
6	GH	High side gate signal
7	PHASE	Return path of HS gate driver
8 to 14, P2	V _{IN}	Power stage input voltage. Drain of high side MOSFET
15, 29 to 35, P3	V _{SWH}	Phase node of the power stage
16 to 28	P _{GND}	Power ground
36	GL	Low side gate signal
38	THWn	Thermal warning open drain output
39	DSBL#	Disable pin; active low
40	PWM	PWM input logic

ORDERING INFORMATION		
PART NUMBER	PACKAGE	MARKING CODE
SiC770CD-T1-GE3	PowerPAK MLP66-40L	SiC770CD
SiC770DB	Reference Board	



ABSOLUTE MAXIMUM RATINGS			
ELECTRICAL PARAMETER	SYMBOL	LIMITS	UNIT
Input Voltage	V_{IN}	- 0.3 to 30	V
Control Input Voltage	V_{CIN}	- 0.3 to 7	V
Drive Input Voltage	V_{DRV}	- 0.3 to 7	V
Switch Node (DC)	V_{SW}	- 0.3 to 30	V
Switch Node (AC) ⁽¹⁾		- 8 to 35	V
Boot Voltage (DC Voltage)	V_{BS}	- 0.3 to 32	V
Boot to Switching Node (DC Voltage)	V_{BS_SW}	- 0.3 to 7	V
All Logic Inputs and Outputs (PWM, DSBL, SMOD, and THDN)		- 0.3 to $V_{CIN} + 0.3$	V
Max. Operating Junction Temperature	T_J	150	°C
Ambient Temperature	T_A	- 40 to 125	°C
Storage Temperature		- 65 to 150	°C

Notes

- Stresses beyond those listed under “Absolute Maximum Ratings” may cause permanent damage to the device. These are stress ratings only, and functional operation of the device at these or any other conditions beyond those indicated in the operational sections of the specifications is not implied. Exposure to absolute maximum rating conditions for extended periods may affect device reliability.
- ⁽¹⁾ The specification values indicated “AC” is V_{SW} to PGND - 8 V (< 20 ns, 10 μ J), minimum and 35 V (< 50 ns), maximum.

RECOMMENDED OPERATING RANGE				
ELECTRICAL	MIN.	TYP.	MAX.	UNIT
Input Voltage (V_{IN})	4.5		24	V
Drive Input Voltage (V_{DRV})	4.5	5	5.5	V
Control Input Voltage (V_{CIN})	4.5	5	5.5	V
Switching Node (LX, DC Voltage)			27	V
BOOT-SW	4	4.5	5.5	V
THERMAL RESISTANCE				
Thermal Resistance from Junction to Case (to P3 PAD “VSWH”)		2.5		°C/W
Thermal Resistance from Junction to PCB		5		°C/W



ELECTRICAL SPECIFICATIONS (DSBL# = 5 V, SMOD = 5 V, V_{IN} = 19 V, V_{DRV} and V_{CIN} = 5 V, T_A = 25 °C)							
PARAMETER	SYMBOL	TEST CONDITIONS UNLESS SPECIFIED	MIN.	TYP.	MAX.	UNIT	
POWER SUPPLIES							
Control Logic Input Current	I _{VCIN}	V _{DSBL#} = 0 V, no switching		21		μA	
		V _{DSBL#} = 5 V, no switching		350			
		V _{DSBL#} = 5 V, f _S = 300 kHz, D = 0.1		500			
Drive Input Current (Dynamic)	I _{VDRV}	f _S = 300 kHz, D = 0.1		14		mA	
		f _S = 1 MHz, D = 0.1		40			
BOOTSTRAP SUPPLY							
Bootstrap Switch Forward Voltage	V _F	V _{CIN} = 5 V, forward bias current 2 mA		0.6		V	
PWM CONTROL INPUT							
Rising Threshold	PWM _{TH_R}		3.5	3.9	4.2	V	
Falling Threshold	PWM _{TH_F}		0.8	1.0	1.2	V	
Tri-state Voltage	V _{TRI}	PWM pin floating		2.3		V	
Tri-state Rising Threshold	V _{TRI_TH_R}		0.9	1.3	1.8	V	
Tri-state Falling Threshold	V _{TRI_TH_F}		3.4	3.7	4.0	V	
Tri-state Rising Threshold Hysteresis	V _{TRI_HYS_R}			280		mV	
Tri-state Falling Threshold Hysteresis	V _{TRI_HYS_F}			180		mV	
PWM Input Current	I _{PWM}	V _{PWM} = 5 V		250		μA	
		V _{PWM} = 0 V		- 250			
TIMING SPECIFICATIONS							
Tri-state to GH/GL Rising Propagation Delay	T _{PD_R_Tri}	No load, see fig. 4		20		ns	
Tri-state Hold-Off Time	T _{TSHO}			150		ns	
GH - Turn Off Propagation Delay	T _{PD_OFF_GH}			20		ns	
GH - Turn ON Propagation Delay (Dead Time Rising)	T _{PD_ON_GH}			15		ns	
GL - Turn Off Propagation Delay	T _{PD_OFF_GL}			20		ns	
GL - Turn ON Propagation Delay (Dead Time Falling)	T _{PD_ON_GL}			20		ns	
DSBL# Hi to GH/GL Rising Propagation Delay	T _{PD_R_DSBL}				500		ns
DSBL# Lo to GH/GL Falling Propagation Delay	T _{PD_F_DSBL}				200		ns
DSBL# , ZCD_EN# INPUT							
DSBL# Logic Input Voltage	V _{DSBL}	Enable	2			V	
		Disenable			0.8		
ZCD_EN# Logic Input Voltage	V _{SMOD}	High State	2			V	
		Low State			0.8		
PROTECTION							
Under Voltage Lockout	V _{UVLO}	Rising, On Threshold		3.3	3.9	V	
		Falling, Off Threshold	2.3	2.95			
Under Voltage Lockout Hysteresis				400		mV	
THWn Flag Set ⁽²⁾		⁽²⁾		160		°C	
THWn Flag Clear ⁽²⁾				135		°C	
THWn Flag Hysteresis ⁽²⁾				25		°C	
THWn Output Low				0.02		V	

Notes

- (1) Typical limits are established by characterization and are not production tested.
- (2) Guaranteed by design.
- (3) Min. and max. parameters are not 100 % production tested.



DETAILED OPERATIONAL DESCRIPTION

PWM Input with Tri-State Function

The PWM input receives the PWM control signal from the VR controller IC. The PWM input is designed to be compatible with standard controllers using two state logic (H and L) and advanced controllers that incorporate tri-state logic (H, L, and tri-state) on the PWM output. For two state logic, the PWM input operates as follows. When PWM is driven above $V_{th_pwm_r}$ the low side is turned OFF and the high side is turned ON. When PWM input is driven below $V_{th_pwm_f}$ the high side turns off and the low side turns on. For tri-state logic, the PWM input operates as above for driving the MOSFETs. However, there is a third state that is entered into as the PWM output of tri-state compatible controller enters its high impedance state during shut-down. The high impedance state of the controller's PWM output allows the SiC770 to pull the PWM input into the tri-state region (see the tri-state Voltage Threshold diagram below). If the PWM input stays in this region for the tri-state hold-off period, t_{TSHO} , both high side and low side MOSFETs are turned off. This function allows the VR phase to be disabled without negative output voltage swing caused by inductor ringing and saves a schottky diode clamp. The PWM and tri-state regions are separated by hysteresis to prevent false triggering. The SiC770CD incorporates PWM voltage thresholds that are compatible with 5 V logic.

Disable (DSBL#)

In the low state, the DSBL# pin shuts down the driver IC and disables both high-side and low-side MOSFET. In this state, the standby current is minimized. If DSBL# is left unconnected an internal pull-down resistor will pull the pin down to CGND and shut down the IC.

Diode Emulation Mode (ZCD_EN#) Skip

When ZCD_EN# pin is low the diode emulation mode is enabled. This is a non-synchronous conversion mode that improves light load efficiency by reducing switching losses. Conducted losses that occur in synchronous buck regulators when inductor current is negative are also reduced. Circuitry in the gate drive IC detects the inductor valley current when inductor current crosses zero and automatically stops switching the low side MOSFET. See ZCD_EN# operation diagram for additional details. This function can be also be used for a pre-biased output voltage. If ZCD_EN# is left un-connected, an internal pull up resistor will pull the pin up to V_{CIN} (logic high) to disable the ZCD_EN# function.

Thermal Shutdown Warning (THWn)

The THWn pin is an open drain signal that flags the presence of excessive junction temperature. Connect a maximum of 20 k Ω to pull this pin up to V_{CIN} . An internal temperature sensor detects the junction temperature. The temperature threshold is 160 °C. When this junction temperature is exceeded the THWn flag is set. When the junction temperature drops below 135 °C the device will clear the THWn signal. The SiC770 does not stop operation when the flag is set. The decision to shutdown must be made by an external thermal control function.

Voltage Input (V_{IN})

This is the power input to the drain of the high-side Power MOSFET. This pin is connected to the high power intermediate BUS rail.

Switch Node (V_{SWH} and PHASE)

The switch node V_{SWH} is the circuit PWM regulated output. This is the output applied to the filter circuit to deliver the regulated high output for the buck converter. The PHASE pin is internally connected to the switch node V_{SWH} . This pin is to be used exclusively as the return pin for the BOOT capacitor. A 20 k Ω resistor is connected between GH and PHASE to provide a discharge path for the HS MOSFET in the event that V_{CIN} goes to zero while V_{IN} is still applied.

Ground connections (C_{GND} and P_{GND})

P_{GND} (power ground) should be externally connected to C_{GND} (control signal ground). The layout of the printed circuit board should be such that the inductance separating the C_{GND} and P_{GND} should be a minimum. Transient differences due to inductance effects between these two pins should not exceed 0.5 V.

Control and Drive Supply Voltage Input (V_{DRV} , V_{CIN})

V_{CIN} is the bias supply for the gate drive control IC. V_{DRV} is the bias supply for the gate drivers. It is recommended to separate these pins through a resistor. This creates a low pass filtering effect to avoid coupling of high frequency gated rive noise into the IC.

Bootstrap Circuit (BOOT)

The internal bootstrap switch and an external bootstrap capacitor form a charge pump that supplies voltage to the BOOT pin. An integrated bootstrap diode is incorporated so that only an external capacitor is necessary to complete the bootstrap circuit. Connect a boot strap capacitor with one leg tied to BOOT pin and the other tied to PHASE pin.

Shoot-Through Protection and Adaptive Dead Time (AST)

The SiC770 has an internal adaptive logic to avoid shoot through and optimize dead time. The shoot through protection ensures that both high-side and low-side MOSFET are not turned on the same time. The adaptive dead time control operates as follows. The HS and LS gate voltages are monitored to prevent the one turning on until the other's gate voltage is sufficiently low (1.0 V), that and built in delays ensure the one Power MOS is completely off, before the other can be turned on. This feature helps to adjust dead time as gate transitions change with respect to output current and temperature.

Under Voltage Lockout (UVLO)

During the start up cycle, the UVLO disables the gate drive holding high-side and low-side MOSFET gate low until the input voltage rail has reached a point at which the logic circuitry can be safely activated. The SiC770 also incorporates logic to clamp the gate drive signals to zero when the UVLO falling edge triggers the shutdown of the device. As an added precaution, a 20.2 kΩ resistor is connected between GH and PHASE to provide a discharge path for the HS MOSFET.

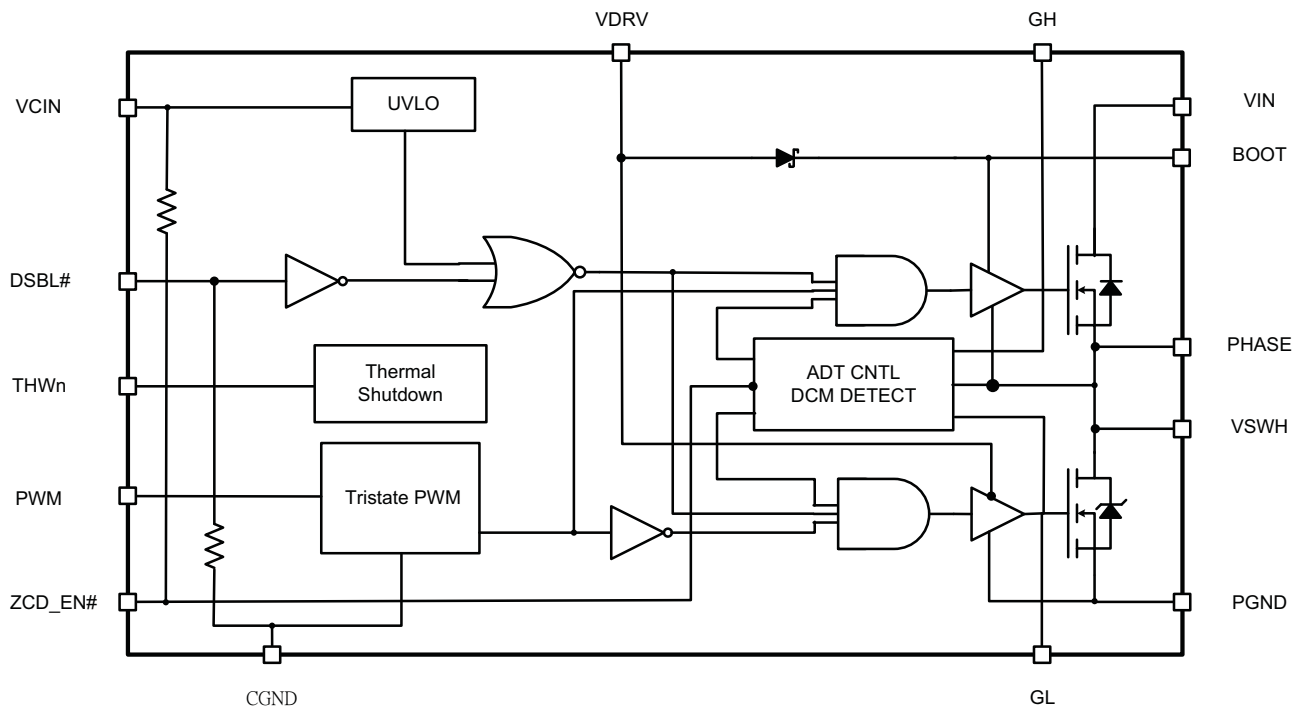
FUNCTIONAL BLOCK DIAGRAM

Fig. 3 - SiC770 Functional Block Diagram

DEVICE TRUTH TABLE				
DSBL#	SMOD	PWM	GH	GL
Open	X	X	L	L
L	X	X	L	L
H	L	L	L	H (IL > 0), L (IL ≤ 0)
H	L	H	H	L
H	H	H	H	L
H	H	L	L	H

PWM TIMING DIAGRAM

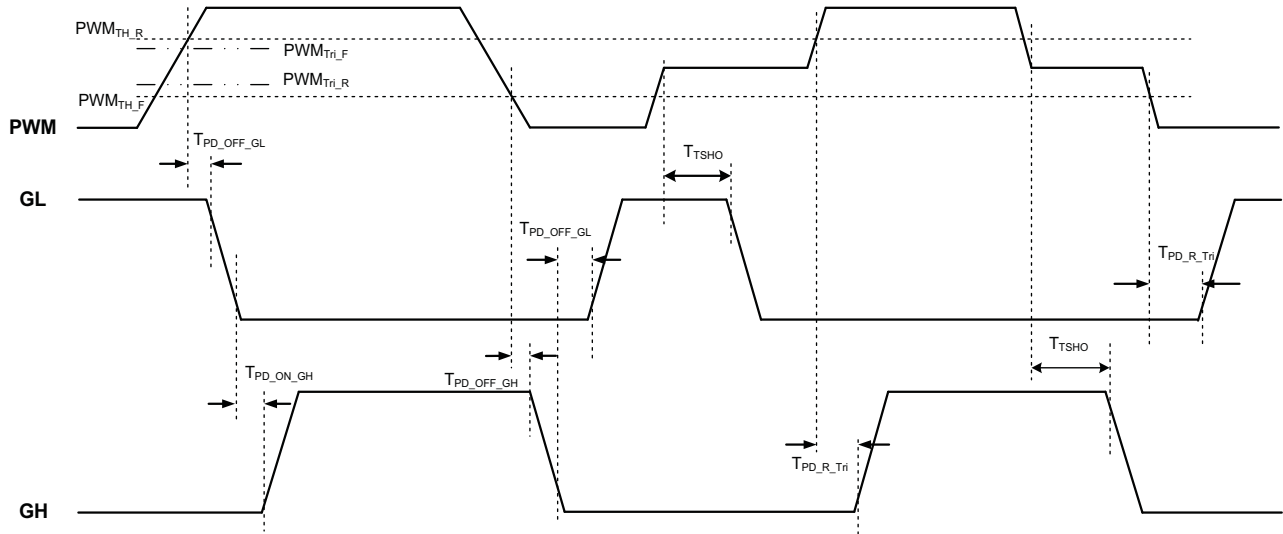

Fig. 4 - Definition of PWM Logic and Tri-State

PWM TIMING DIAGRAM

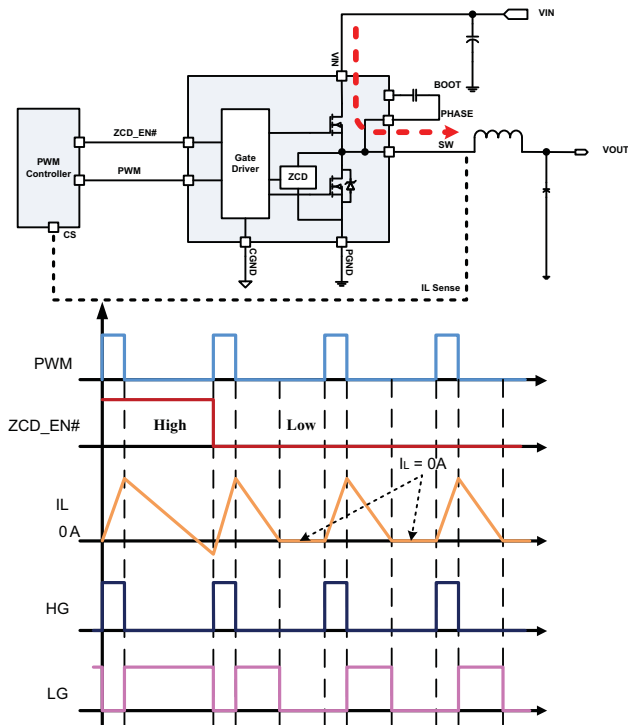

Fig. 5 - ZCD_EN# Operation Timing Diagram

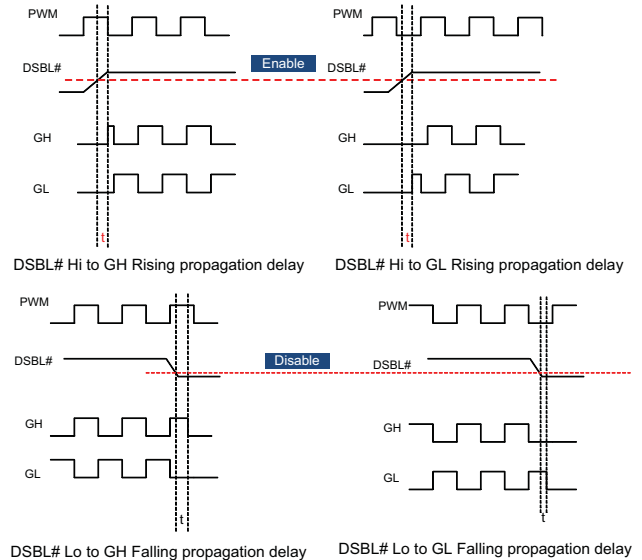
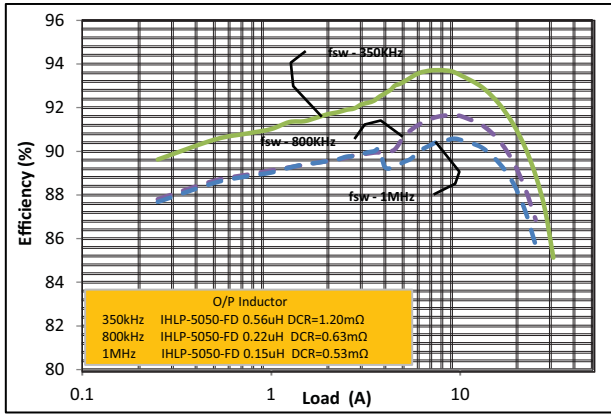

Fig. 6 - DSBL# Function Timing Diagram



ELECTRICAL CHARACTERISTICS



Efficiency Performance vs. f_{sw}
 $V_{IN} = 12\text{ V}, V_{OUT} = 1.8\text{ V}$

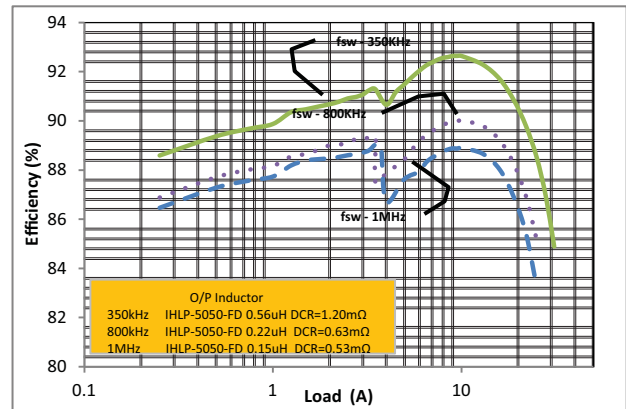

Efficiency Performance vs. f_{sw}
 $V_{IN} = 19\text{ V}, V_{OUT} = 1.8\text{ V}$

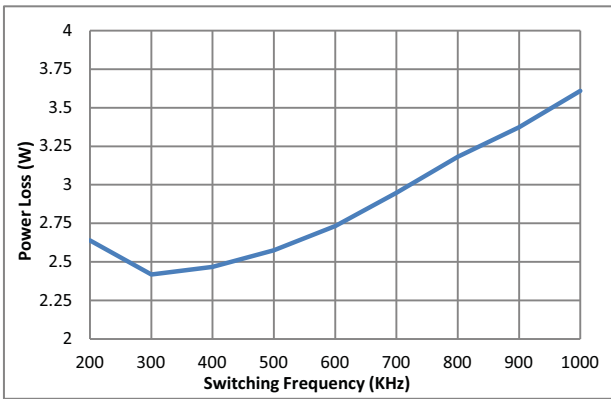

Power Loss vs. Switching Frequency
 $V_{IN} = 19\text{ V}, V_{OUT} = 1.8\text{ V}, I_{OUT} = 15\text{ A}, R_{boot} = 4.7\ \Omega,$
 Inductance = $0.47\ \mu\text{H}$

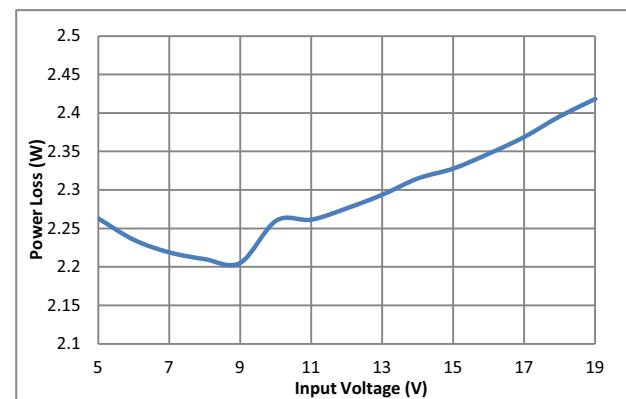

Power Loss vs. Input Voltage
 $V_{OUT} = 1.8\text{ V}, I_{OUT} = 15\text{ A}, f_{sw} = 300\text{ kHz}, R_{boot} = 4.7\ \Omega,$
 Inductance = $0.47\ \mu\text{H}$

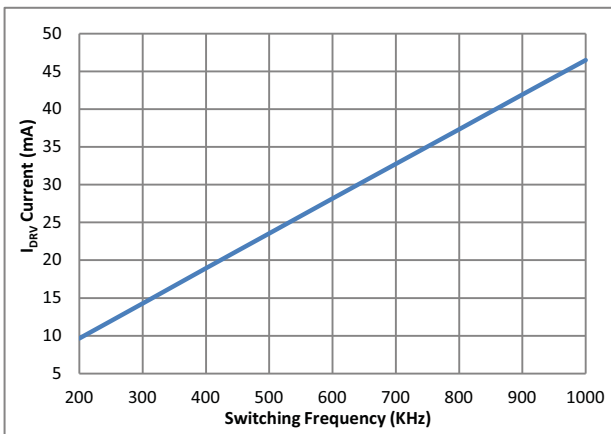

Driver Current vs. Switching Frequency
 $V_{IN} = 12\text{ V}, V_{OUT} = 1.8\text{ V}, I_{OUT} = 20\text{ A}, V_{CIN} = V_{DRV} = 5\text{ V}$

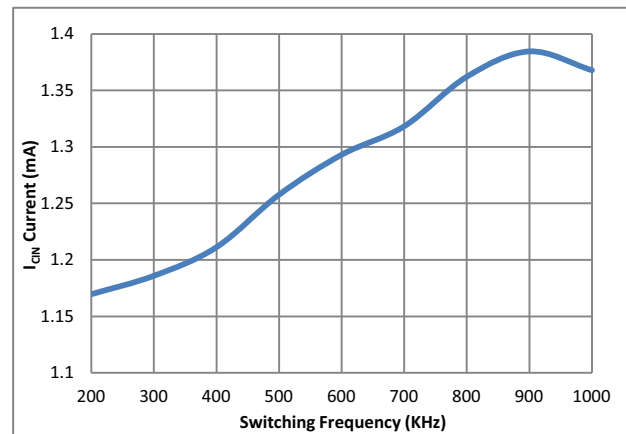

V_{CIN} Current vs. Switching Frequency
 $V_{IN} = 12\text{ V}, V_{OUT} = 1.8\text{ V}, I_{OUT} = 20\text{ A}, V_{CIN} = V_{DRV} = 5\text{ V}$

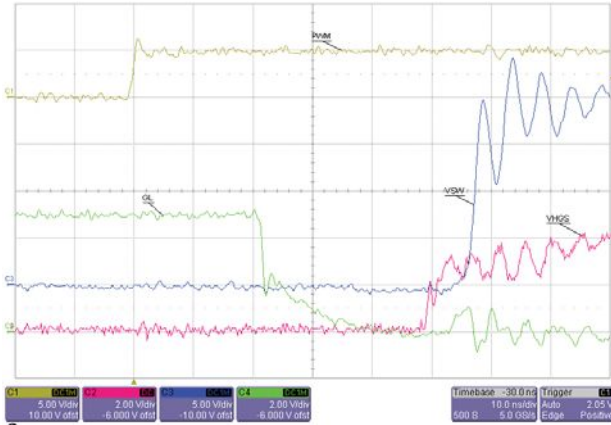

Switching Waveform at PWM Rising Edge
 $V_{IN} = 19\text{ V}$, $V_O = 1.8\text{ V}$, $I_O = 20\text{ A}$, $f_{SW} = 500\text{ kHz}$

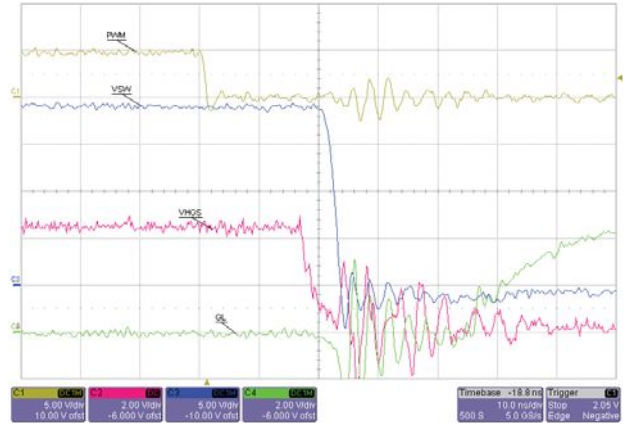

Switching Waveform at PWM Falling Edge
 $V_{IN} = 19\text{ V}$, $V_O = 1.8\text{ V}$, $I_O = 20\text{ A}$, $f_{SW} = 500\text{ kHz}$

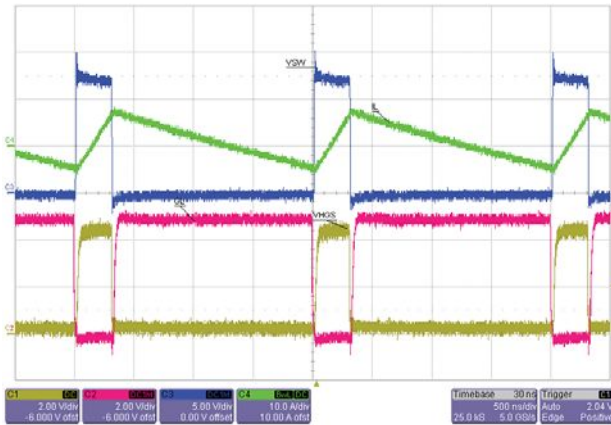

Switching Waveform at ZCD_EN# - High
 $V_{IN} = 12\text{ V}$, $V_O = 1.8\text{ V}$, $I_L = 1\text{ A}$, $f_{SW} = 500\text{ kHz}$

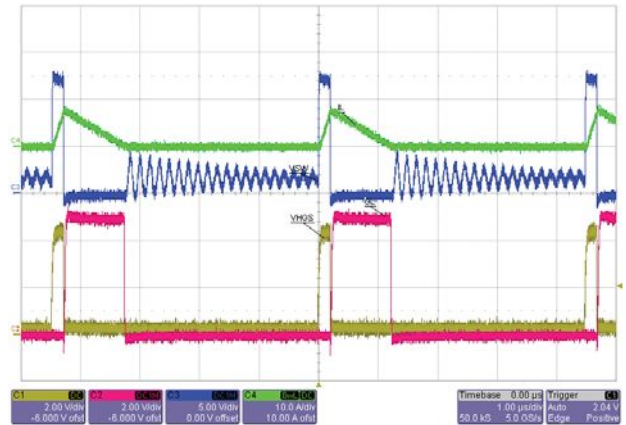

Switching Waveform at ZCD_EN# - Low
 $V_{IN} = 12\text{ V}$, $V_O = 1.8\text{ V}$, $I_L = \text{DCM}$, $t_{on} = 200\text{ ns}$

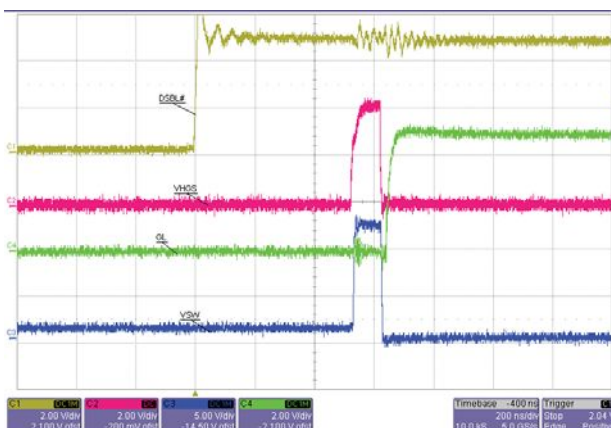

DSBL# Hi to GH Rising Propagation Delay
 $V_{IN} = 12\text{ V}$, $t_{on} = 200\text{ ns}$, $f_{SW} = 500\text{ kHz}$, $I_O = 0\text{ A}$

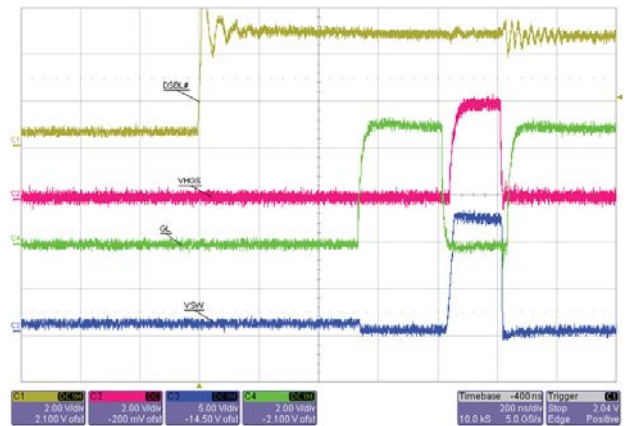

DSBL# Hi to GL Rising Propagation Delay
 $V_{IN} = 12\text{ V}$, $t_{on} = 200\text{ ns}$, $f_{SW} = 500\text{ kHz}$, $I_O = 0\text{ A}$

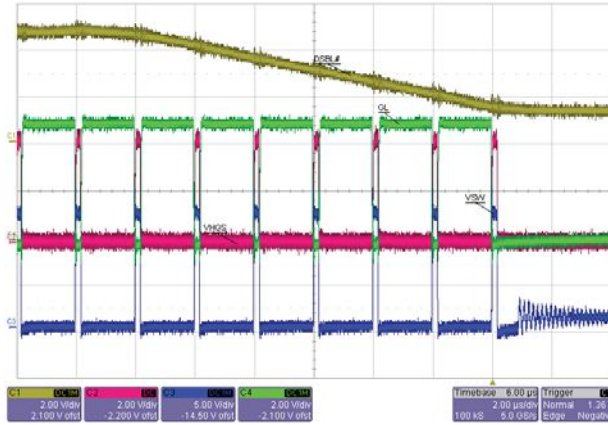

DSBL# Lo to GH Falling Propagation Delay

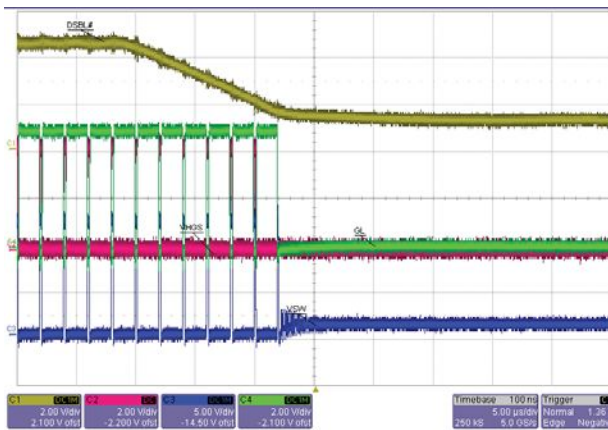

DSBL# Lo to GL Falling Propagation Delay

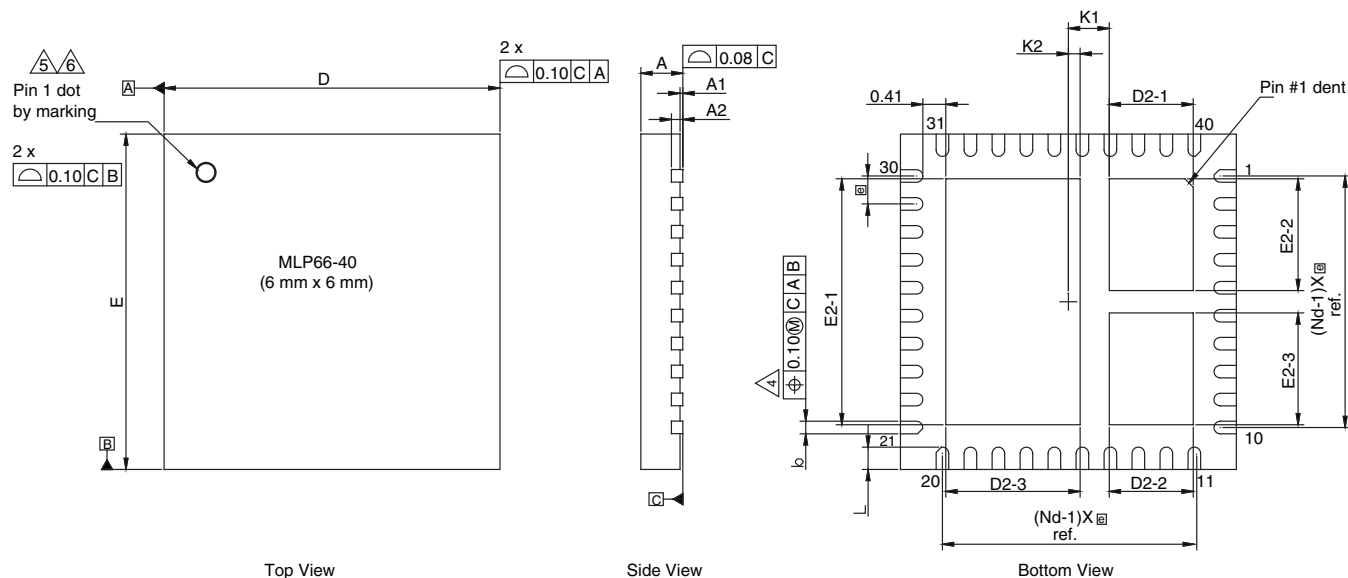
PACKAGE MECHANICAL DRAWING

DIM.	MILLIMETERS			INCHES		
	MIN.	NOM.	MAX.	MIN.	NOM.	MAX.
A ⁽⁸⁾	0.70	0.75	0.80	0.027	0.029	0.031
A1	0.00	-	0.05	0.000	-	0.002
A2	0.20 ref.			0.008 ref.		
b ⁽⁴⁾	0.20	0.25	0.30	0.078	0.098	0.111
D	6.00 BSC			0.236 BSC		
e	0.50 BSC			0.019 BSC		
E	6.00 BSC			0.236 BSC		
L	0.35	0.40	0.45	0.013	0.015	0.017
N ⁽³⁾	40			40		
Nd ⁽³⁾	10			10		
Ne ⁽³⁾	10			10		
D2-1	1.45	1.50	1.55	0.057	0.059	0.061
D2-2	1.45	1.50	1.55	0.057	0.059	0.061
D2-3	2.35	2.40	2.45	0.095	0.094	0.096
E2-1	4.35	4.40	4.45	0.171	0.173	0.175
E2-2	1.95	2.00	2.05	0.076	0.078	0.080
E2-3	1.95	2.00	2.05	0.076	0.078	0.080
K1	0.73 BSC			0.028 BSC		
K2	0.21 BSC			0.008 BSC		

Notes

1. Use millimeters as the primary measurement
2. Dimensioning and tolerances conform to ASME Y14.5M. - 1994
3. N is the number of terminals. Nd is the number of terminals in X-direction and Ne is the number of terminals in Y-direction
4. Dimension b applies to plated terminal and is measured between 0.20 mm and 0.25 mm from terminal tip
5. The pin #1 identifier must be existed on the top surface of the package by using indentation mark or other feature of package body
6. Exact shape and size of this feature is optional
7. Package warpage max. 0.08 mm
8. Applied only for terminals

Vishay Siliconix maintains worldwide manufacturing capability. Products may be manufactured at one of several qualified locations. Reliability data for Silicon Technology and Package Reliability represent a composite of all qualified locations. For related documents such as package/tape drawings, part marking, and reliability data, see www.vishay.com/ppg?62727.



PowerPAK® MLP66-40 Case Outline

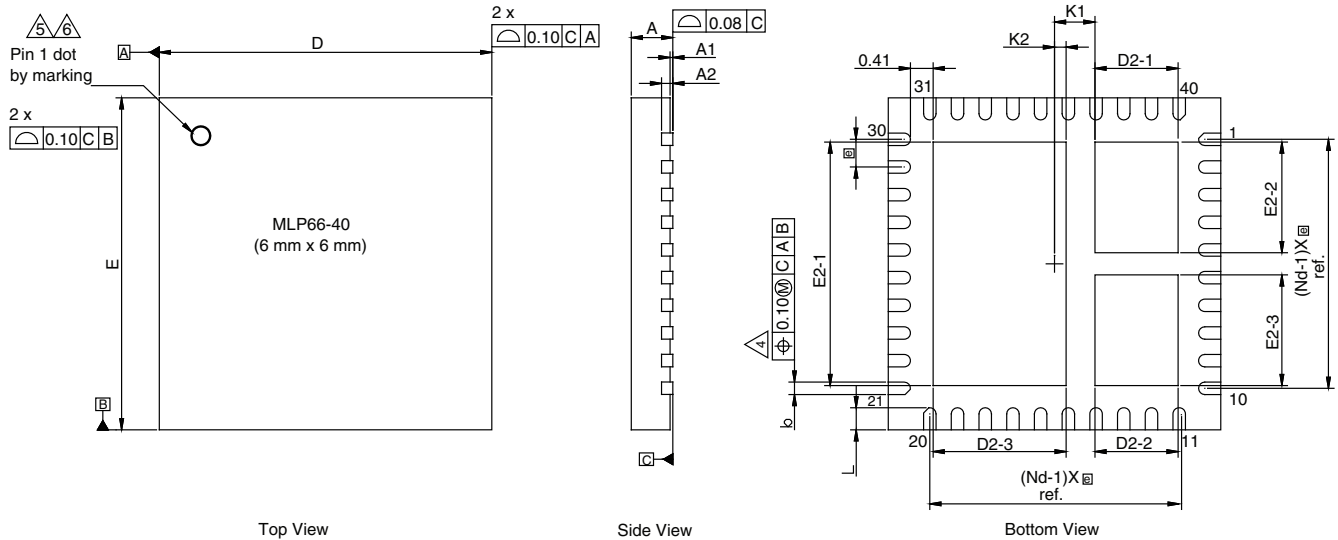

DIM.	MILLIMETERS			INCHES		
	MIN.	NOM.	MAX.	MIN.	NOM.	MAX.
A ⁽⁸⁾	0.70	0.75	0.80	0.027	0.029	0.031
A1	0.00	-	0.05	0.000	-	0.002
A2	0.20 ref.			0.008 ref.		
b ⁽⁴⁾	0.20	0.25	0.30	0.078	0.098	0.011
D	6.00 BSC			0.236 BSC		
e	0.50 BSC			0.019 BSC		
E	6.00 BSC			0.236 BSC		
L	0.35	0.40	0.45	0.013	0.015	0.017
N ⁽³⁾	40			40		
Nd ⁽³⁾	10			10		
Ne ⁽³⁾	10			10		
D2-1	1.45	1.50	1.55	0.057	0.059	0.061
D2-2	1.45	1.50	1.55	0.057	0.059	0.061
D2-3	2.35	2.40	2.45	0.095	0.094	0.096
E2-1	4.35	4.40	4.45	0.171	0.173	0.175
E2-2	1.95	2.00	2.05	0.076	0.078	0.080
E2-3	1.95	2.00	2.05	0.076	0.078	0.080
K1	0.73 BSC			0.028 BSC		
K2	0.21 BSC			0.008 BSC		
ECN: T14-0826-Rev. B, 12-Jan-15						
DWG: 5986						

Notes

1. Use millimeters as the primary measurement
2. Dimensioning and tolerances conform to ASME Y14.5M. - 1994
3. N is the number of terminals. Nd is the number of terminals in X-direction and Ne is the number of terminals in Y-direction
4. Dimension b applies to plated terminal and is measured between 0.20 mm and 0.25 mm from terminal tip
5. The pin #1 identifier must be existed on the top surface of the package by using indentation mark or other feature of package body
6. Exact shape and size of this feature is optional
7. Package warpage max. 0.08 mm
8. Applied only for terminals



Disclaimer

ALL PRODUCT, PRODUCT SPECIFICATIONS AND DATA ARE SUBJECT TO CHANGE WITHOUT NOTICE TO IMPROVE RELIABILITY, FUNCTION OR DESIGN OR OTHERWISE.

Vishay Intertechnology, Inc., its affiliates, agents, and employees, and all persons acting on its or their behalf (collectively, "Vishay"), disclaim any and all liability for any errors, inaccuracies or incompleteness contained in any datasheet or in any other disclosure relating to any product.

Vishay makes no warranty, representation or guarantee regarding the suitability of the products for any particular purpose or the continuing production of any product. To the maximum extent permitted by applicable law, Vishay disclaims (i) any and all liability arising out of the application or use of any product, (ii) any and all liability, including without limitation special, consequential or incidental damages, and (iii) any and all implied warranties, including warranties of fitness for particular purpose, non-infringement and merchantability.

Statements regarding the suitability of products for certain types of applications are based on Vishay's knowledge of typical requirements that are often placed on Vishay products in generic applications. Such statements are not binding statements about the suitability of products for a particular application. It is the customer's responsibility to validate that a particular product with the properties described in the product specification is suitable for use in a particular application. Parameters provided in datasheets and/or specifications may vary in different applications and performance may vary over time. All operating parameters, including typical parameters, must be validated for each customer application by the customer's technical experts. Product specifications do not expand or otherwise modify Vishay's terms and conditions of purchase, including but not limited to the warranty expressed therein.

Except as expressly indicated in writing, Vishay products are not designed for use in medical, life-saving, or life-sustaining applications or for any other application in which the failure of the Vishay product could result in personal injury or death. Customers using or selling Vishay products not expressly indicated for use in such applications do so at their own risk. Please contact authorized Vishay personnel to obtain written terms and conditions regarding products designed for such applications.

No license, express or implied, by estoppel or otherwise, to any intellectual property rights is granted by this document or by any conduct of Vishay. Product names and markings noted herein may be trademarks of their respective owners.

Material Category Policy

Vishay Intertechnology, Inc. hereby certifies that all its products that are identified as RoHS-Compliant fulfill the definitions and restrictions defined under Directive 2011/65/EU of The European Parliament and of the Council of June 8, 2011 on the restriction of the use of certain hazardous substances in electrical and electronic equipment (EEE) - recast, unless otherwise specified as non-compliant.

Please note that some Vishay documentation may still make reference to RoHS Directive 2002/95/EC. We confirm that all the products identified as being compliant to Directive 2002/95/EC conform to Directive 2011/65/EU.

Vishay Intertechnology, Inc. hereby certifies that all its products that are identified as Halogen-Free follow Halogen-Free requirements as per JEDEC JS709A standards. Please note that some Vishay documentation may still make reference to the IEC 61249-2-21 definition. We confirm that all the products identified as being compliant to IEC 61249-2-21 conform to JEDEC JS709A standards.