

## Overview

The KEMET SC-J coils are common mode chokes with a wide variety of characteristics. These toroidal coils are designed with our proprietary ferrite cores and are useful in various noise countermeasure fields.

## Applications

- Audio-visual equipment
- Home appliances
- Power supplies

## Benefits

- Proprietary 5H, 7H and 10H ferrite materials and equivalents
- Suitable for  $\geq 150$  kHz range
- Wide variety of sizes and specifications
- Operating temperature range from  $-25^{\circ}\text{C}$  to  $+105^{\circ}\text{C}$  or  $+120^{\circ}\text{C}$
- UL94 V-0 flame retardant rated base and cap



## Part Number System

SC-		10-		20	J	
Series	Dimension Code (See Dimensions)	Rated Current (A)	Thermal Class	Inductance (mH) Minimum	Terminal Base Type	Internal Control Code
SC	Blank 22	0x = x A x0 = x0 A xx = xx A  Examples: 02 = 2 A 10 = 10 A 15 = 15 A  Note: With exceptions, see Table 1 for details.	Blank E = Class E  Note: With exceptions, see Table 1 for details.	x0 = x mH xx = x.x mH 0x = 0.x mH xxx = xx.x mH  Examples: 20 = 2 mH 15 = 1.5 mH 05 = 0.5 mH 115 = 11.5 mH  Note: With exceptions, see Table 1 for details.	J	Blank A B M MI N P

## Magnetic Permeability of Ferrite Material

In order to achieve most efficient noise reduction, it is important to select the material according to the target frequency band. Depending on its magnetic permeability, a particular ferrite material will be effective in a certain frequency band. A schematic representation of the relationship between the magnetic permeability of each material and the corresponding effective band range is shown in Figure 1. Materials with higher magnetic permeability are effective in the lower frequency range, while those with lower magnetic permeability are effective in the higher frequency range. Thus, Mn-Zn products are mainly used for reducing conduction noise, while Ni-Zn products are commonly used for radiation noise countermeasures.

The effective frequency range varies depending on core shape, size and number of windings. This frequency dependence of the magnetic permeability as shown in the figure serves for reference purposes only and it should be tested on the actual device to determine its effectiveness.

S18H, S15H, 10H, 7H, 5H, 1400L and 700L are KEMET’s proprietary ferrite material names. Other materials can also be available on request.

Figure 1 - Relationship between the magnetic permeability of each material and its effective frequency range



## Dimensions – Millimeters



Part Name	Dimensions (mm)				Pin Pitch <sup>1</sup> (Reference)	
	OD (Maximum)	T (Maximum)	H (Maximum)	L	a	b
SC-02-10J	25.0	20.0	27.0	5.00±2.0	10	15
SC-02-20J	25.0	20.0	27.0	5.00±2.0	10	15
SC-02-30J	25.0	20.0	27.0	5.00±2.0	10	15
SC-02-50J	25.0	20.0	27.0	5.00±2.0	10	15
SC-02-70J	25.0	20.0	27.0	5.00±2.0	10	15
SC-02-100J	25.0	20.0	27.0	5.00±2.0	10	15
SC-02-E115J	25.0	15.4	27.5	3.50±1.0	13	11
SC-02-E120J	24.0	16.0	25.0	3.50±1.5	13	11
SC-02-300J	33.0	23.0	33.0	7.00±2.0	18	16
SC22-025-290J	30.0	20.0	29.0	5.00±2.0	10	15
SC-03-28J	25.0	20.0	27.0	5.00±2.0	10	15
SC-03-30J	25.0	20.0	27.0	5.00±2.0	10	15
SC-03-55J	25.0	20.0	27.0	5.00±2.0	10	15
SC-03-67J	24.0	20.0	26.0	5.00±1.0	10	15
SC-03-85J	25.0	20.0	27.0	5.00±2.0	10	15
SC-04-20JN	25.0	20.0	27.0	5.00±2.0	10	15
SC-05-50J	34.0	23.0	33.0	5.00±2.0	18	16
SC-05-80J	34.0	23.0	33.0	5.00±2.0	18	16
SC22-04-100J	30.0	22.0	32.0	3.50±1.0	18	16
SC-04-200J	34.0	23.0	33.0	5.00±2.0	18	16
SC-04-E17J	23.5	19.4	24.0	3.30±1.0	20	16.5
SC-04-E50J	23.5	19.4	24.0	3.30±1.0	20	16.5
SC-05-06J	25.0	20.0	27.0	10.00±2.0	10	15
SC-05-10J	25.0	20.0	27.0	5.00±2.0	10	15
SC-05-15J	25.0	20.0	27.0	3.40±1.0	22	19
SC-05-21J	34.0	23.0	33.0	5.00±2.0	18	16
SC-05-20J	34.0	23.0	33.0	5.00±2.0	18	16
SC-05-27J	25.0	20.0	27.0	5.00±2.0	10	15
SC-05-30J	34.0	23.0	33.0	5.00±2.0	18	16
SC22-05-30J	28.0	18.5	29.0	5.00±2.0	10	15
SC22-05-70J	28.0	18.5	29.0	5.00±2.0	10	15
SC-05-100J	34.0	23.0	33.0	5.00±2.0	18	16
SC-06-10J-B	25.0	20.0	27.0	4.50±1.0	10	15
SC-06-35J	34.0	24.0	33.0	3.50±1.0	12	17
SC-06-40J	35.0	25.0	33.0	5.00±1.0	18	16
SC-06-60J	34.0	25.0	33.0	5.00±2.0	18	16
SC22-06-60J	29.5	20.5	29.5	5.00±2.0	10	15
SC-07-10J	34.0	23.0	33.0	5.00±1.5	18	16
SC-07-30JM	33.0	23.0	33.0	3.75±1.0	18	16
SC-07-42J	34.0	24.0	33.0	4.50±1.0	18	16

<sup>1</sup> Pin pitch listed above for reference only. Values not guaranteed.

## Dimensions – Millimeters cont.

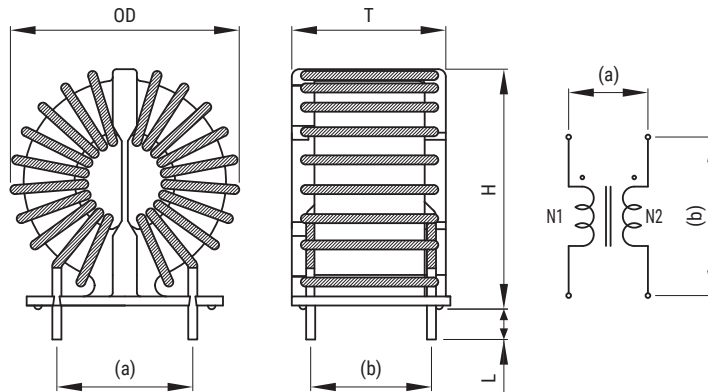

Part Name	Dimensions (mm)				Pin Pitch <sup>1</sup> (Reference)	
	OD (Maximum)	T (Maximum)	H (Maximum)	L	a	b
SC-07-70J	35.0	25.0	35.0	5.00±2.0	18	16
SC-07-90J	34.0	23.0	33.0	5.00±2.0	18	16
SC-07-50J	34.0	24.0	33.0	4.10±1.5	18	16
SC-08-E075J	25.0	16.0	25.5	3.50±1.0	19.5	11
SC-08-20J	34.0	23.0	33.0	7.00±2.0	12	17
SC-08-30J	34.0	23.0	33.0	5.00±2.0	18	16
SC-08-44J	35.0	23.0	33.0	5.00±2.0	18	16
SC-08-100JM	41.0	32.0	40.0	3.50±1.0	18	16
SC-10-E035J	25.0	16.0	24.0	4.00±1.5	19.5	11
SC-10-10J	34.0	23.0	33.0	5.00±2.0	12	17
SC-10-14J	34.0	24.0	33.0	5.00±2.0	12	17
SC-10-15J-MI	34.0	23.0	34.0	3.75±1.0	12	17
SC-10-18J	34.0	24.0	33.0	7.00±2.0	18	16
SC-10-20J	42.0	29.0	44.0	5.00±2.0	18	22
SC-10-30J	34.0	24.0	33.0	5.00±2.0	18	16
SC-10-E55J	44.0	30.0	44.0	5.00±2.0	18	22
SC-11-16J	35.0	23.0	33.0	5.00±2.0	18	16
SC-11-20J	35.0	23.0	33.0	5.00±2.0	18	16
SC-12-E035J	25.0	16.0	25.5	4.00±1.5	19.5	11
SC-12-15J	42.0	29.0	44.0	5.00±2.0	18	22
SC-14-12J	34.0	24.0	33.0	5.00±2.0	18	16
SC-15-02J	34.0	23.0	33.0	5.00±2.0	18	16
SC-15-05J	34.0	23.0	33.0	5.00±2.0	18	16
SC-15-07J	36.0	25.0	35.0	5.00±2.0	18	16
SC-15-09J	36.0	25.0	35.0	5.00±2.0	18	16
SC-15-10J	44.0	30.0	44.0	5.00±2.0	18	22
SC-15-12J-MI	35.0	25.0	35.0	3.75±1.0	18	16
SC-15-E37J	44.0	30.0	44.0	5.00±2.0	18	22
SC-18-05J	44.0	30.0	44.0	5.00±2.0	18	22
SC-18-10J	35.0	24.0	33.0	5.00±2.0	18	16
SC-18-085J	36.0	25.0	35.0	5.00±2.0	18	16
SC-18-095J	36.0	25.0	35.0	5.00±2.0	18	16
SC-18-E12J	50.0	31.0	50.0	4.10±1.0	40	25
SC-18-E15J	44.0	30.0	44.0	5.00±2.0	18	12
SC-18-25J	44.0	30.0	44.0	4.50±1.0	18	22
SC-20-01J-A	35.0	24.0	34.0	4.50±1.0	18	16
SC-20-03J	35.0	24.0	34.0	4.50±1.0	18	16
SC-20-05J-P	36.0	25.0	35.0	5.00±2.0	18	16
SC-20-E085JM	46.0	32.0	46.0	5.00±2.0	18	22
SC-20-E18J	50.0	31.0	53.0	5.00±2.0	40	25

<sup>1</sup> Pin pitch listed above for reference only. Values not guaranteed.

## Environmental Compliance

All KEMET AC line filters are RoHS Compliant.



## Performance Characteristics

Item	Performance Characteristics
Rated Voltage	250 VAC/VDC
Withstanding Voltage	2,400 V (2 seconds, between lines)
Insulation Resistance	> 100 MΩ at 500 VDC (between lines)
Rated Current Range	2 – 20 A
Rated Inductance Range	0.15 – 30 mH minimum
Inductance Measurement Condition	1 kHz, 10 kHz, 16kHz, and 100 kHz
Thermal Class	A (105°C) and E (120°C)
Operating Temperature Range	-25°C to +105°C (include self temperature rise) and -25°C to +120°C (include self temperature rise)

**Table 1 – Ratings & Part Number Reference**

Part Number	Rated Current (A)	Inductance (mH) Minimum	DC Resistance/Line (mΩ) Maximum	Temperature Rise (K) Maximum	Wire Diameter (mm)	Thermal Class	Weight (g) Approximate
SC-02-10J	2.0	1.0000 <sup>4</sup>	100.0	40.0	0.60	E (120°C)	15.0
SC-02-20J	2.0	2.0000 <sup>4</sup>	110.0	40.0	0.60	E (120°C)	15.0
SC-02-30J	2.0	3.0000 <sup>4</sup>	110.0	40.0	0.60	E (120°C)	16.0
SC-02-50J	2.0	5.0000 <sup>4</sup>	120.0	40.0	0.60	E (120°C)	20.0
SC-02-70J	2.0	7.0000 <sup>1</sup>	110.0	40.0	0.60	E (120°C)	18.2
SC-02-100J	2.0	10.0000 <sup>4</sup>	220.0	55.0	0.50	E (120°C)	18.0
SC-02-E115J	2.0	11.5000 <sup>2</sup>	155.0	55.0	0.50	E (120°C)	13.0
SC-02-E120J	2.0	12.0000 <sup>2</sup>	180.0	70.0	0.55	E (120°C)	13.0
SC-02-300J	2.0	30.0000 <sup>1</sup>	300.0	45.0	0.60	E (120°C)	36.9
SC22-025-290J	2.5	29.0000 <sup>2</sup>	250.0	65.0	0.60	E (120°C)	31.4
Part Number	Rated Current (A)	Inductance (mH) Minimum	DC Resistance/Line (mΩ) Maximum	Temperature Rise (K) Maximum	Wire Diameter (mm)	Thermal Class	Weight (g) Approximate

<sup>1</sup> Inductance Measurement Condition: 1 kHz

<sup>2</sup> Inductance Measurement Condition: 10 kHz

<sup>3</sup> Inductance Measurement Condition: 16 kHz

<sup>4</sup> Inductance Measurement Condition: 100 kHz

**Table 1 – Ratings & Part Number Reference cont.**

Part Number	Rated Current (A)	Inductance (mH) Minimum	DC Resistance/Line (mΩ) Maximum	Temperature Rise (K) Maximum	Wire Diameter (mm)	Thermal Class	Weight (g) Approximate
SC-03-28J	3.0	2.8000 <sup>2</sup>	55.0	40.0	0.70	E (120°C)	18.7
SC-03-30J	3.0	3.0000 <sup>4</sup>	110.0	50.0	0.65	E (120°C)	19.6
SC-03-55J	3.0	5.5000 <sup>4</sup>	110.0	60.0	0.65	E (120°C)	22.0
SC-03-67J	3.0	6.7000 <sup>4</sup>	105.0	65.0	0.65	E (120°C)	21.0
SC-03-85J	3.0	8.5000 <sup>2</sup>	110.0	60.0	0.65	E (120°C)	22.0
SC-04-20JN	4.0	2.0000 <sup>4</sup>	50.0	50.0	0.80	E (120°C)	20.4
SC-05-50J	4.0	5.0000 <sup>4</sup>	80.0	60.0	0.80	E (120°C)	32.0
SC-05-80J	4.0	8.0000 <sup>4</sup>	90.0	60.0	0.80	E (120°C)	42.0
SC22-04-100J	4.0	10.0000 <sup>2</sup>	71.0	50.5	0.80	E (120°C)	30.0
SC-04-200J	4.0	20.3000 <sup>1</sup>	150.0	55.0	0.80	E (120°C)	43.2
SC-04-E17J	4.3	1.7850 <sup>2</sup>	31.8	45.0	0.70	E (120°C)	16.5
SC-04-E50J	4.3	5.1800 <sup>2</sup>	56.4	70.0	0.70	E (120°C)	19.2
SC-05-06J	5.0	0.6000 <sup>4</sup>	27.0	40.0	0.80	E (120°C)	16.7
SC-05-10J	5.0	1.0000 <sup>4</sup>	50.0	40.0	0.80	E (120°C)	20.0
SC-05-15J	5.0	1.5000 <sup>4</sup>	40.0	45.0	0.80	E (120°C)	18.7
SC-05-20J	5.0	2.0000 <sup>4</sup>	70.0	40.0	0.80	E (120°C)	25.0
SC-05-21J	5.0	2.0000 <sup>4</sup>	40.0	35.0	1.00	E (120°C)	38.6
SC-05-27J	5.0	2.7000 <sup>1</sup>	40.0	57.0	0.80	E (120°C)	19.4
SC-05-30J	5.0	3.0000 <sup>4</sup>	70.0	55.0	0.80	E (120°C)	30.0
SC22-05-30J	5.0	3.0000 <sup>2</sup>	50.0	50.0	0.80	E (120°C)	30.6
SC22-05-70J	5.0	7.0000 <sup>2</sup>	60.0	75.0	0.80	E (120°C)	31.9
SC-05-100J	5.0	10.5000 <sup>3</sup>	100.0	55.0	0.90	E (120°C)	40.8
SC-06-10J-B	6.0	1.0000 <sup>1</sup>	30.0	45.0	0.85	E (120°C)	18.9
SC-06-35J	6.0	3.5000 <sup>2</sup>	50.0	51.0	1.00	E (120°C)	40.0
SC-06-40J	6.0	4.0000 <sup>1</sup>	40.0	50.0	1.10	E (120°C)	47.9
SC-06-60J	6.0	6.0000 <sup>2</sup>	60.0	70.0	1.00	E (120°C)	44.1
SC22-06-60J	6.0	6.0000 <sup>2</sup>	46.0	83.0	0.90	E (120°C)	29.0
SC-07-10J	7.0	1.0000 <sup>4</sup>	24.0	45.0	1.00	E (120°C)	34.3
SC-07-30JM	7.0	3.0000 <sup>2</sup>	39.0	50.0	1.00	E (120°C)	43.0
SC-07-42J	7.0	4.2000 <sup>4</sup>	42.0	65.0	1.10	E (120°C)	45.2
SC-07-70J	7.0	7.0000 <sup>1</sup>	40.0	65.0	1.10	E (120°C)	45.0
SC-07-90J	7.0	9.0000 <sup>2</sup>	50.0	85.0	1.00	E (120°C)	45.8
SC-07-50J	7.3	5.0000 <sup>2</sup>	27.0	55.0	1.20	E (120°C)	53.0
SC-08-E075J	8.0	0.7500 <sup>2</sup>	12.7	55.0	0.90	E (120°C)	16.4
SC-08-20J	8.0	2.0000 <sup>4</sup>	50.0	45.0	1.20	E (120°C)	45.6
Part Number	Rated Current (A)	Inductance (mH) Minimum	DC Resistance/Line (mΩ) Maximum	Temperature Rise (K) Maximum	Wire Diameter (mm)	Thermal Class	Weight (g) Approximate

<sup>1</sup> Inductance Measurement Condition: 1 kHz

<sup>2</sup> Inductance Measurement Condition: 10 kHz

<sup>3</sup> Inductance Measurement Condition: 16 kHz

<sup>4</sup> Inductance Measurement Condition: 100 kHz

**Table 1 – Ratings & Part Number Reference cont.**

Part Number	Rated Current (A)	Inductance (mH) Minimum	DC Resistance/Line (mΩ) Maximum	Temperature Rise (K) Maximum	Wire Diameter (mm)	Thermal Class	Weight (g) Approximate
SC-08-30J	8.0	3.0000 <sup>4</sup>	54.0	55.0	1.00	E (120°C)	40.9
SC-08-44J	8.0	4.4000 <sup>4</sup>	25.0	50.0	1.20	E (120°C)	46.1
SC-08-100JM	8.0	13.0000 <sup>4</sup>	50.0	70.0	1.30	E (120°C)	93.0
SC-10-E035J	10.0	0.3500 <sup>2</sup>	8.0	46.0	1.00	E (120°C)	11.0
SC-10-10J	10.0	1.0000 <sup>4</sup>	20.0	40.0	1.30	A (105°C)	42.0
SC-10-14J	10.0	1.4000 <sup>4</sup>	18.0	65.0	1.30	E (120°C)	43.9
SC-10-15J-MI	10.0	1.5000 <sup>4</sup>	15.7	65.0	1.30	E (120°C)	45.0
SC-10-18J	10.0	1.6000 <sup>1</sup>	20.0	55.0	1.30	E (120°C)	45.2
SC-10-20J	10.0	2.0000 <sup>4</sup>	22.0	50.0	1.40	A (105°C)	70.0
SC-10-30J	10.0	3.0000 <sup>4</sup>	30.0	75.0	1.20	E (120°C)	65.0
SC-10-E55J	10.0	5.5000 <sup>2</sup>	24.0	70.0	1.40	E (120°C)	82.0
SC-11-16J	11.0	1.6000 <sup>2</sup>	13.0	45.0	1.20	E (120°C)	35.0
SC-11-20J	11.0	2.0000 <sup>2</sup>	14.0	50.0	1.40	E (120°C)	44.1
SC-12-E035J	12.0	0.3500 <sup>2</sup>	8.0	60.0	1.10	E (120°C)	11.0
SC-12-15J	12.0	1.5000 <sup>4</sup>	18.0	50.0	1.50	A (105°C)	70.0
SC-14-12J	14.0	1.2000 <sup>2</sup>	12.2	55.0	1.50	E (120°C)	45.0
SC-15-02J	15.0	0.2000 <sup>4</sup>	6.0	45.0	1.60	E (120°C)	43.0
SC-15-05J	15.0	0.5000 <sup>4</sup>	8.0	60.0	1.50	E (120°C)	40.0
SC-15-07J	15.0	0.7020 <sup>4</sup>	10.0	60.0	1.60	E (120°C)	46.4
SC-15-09J	15.0	0.9000 <sup>4</sup>	20.0	65.0	1.50	E (120°C)	45.5
SC-15-10J	15.0	1.0000 <sup>4</sup>	12.0	55.0	1.70	A (105°C)	75.0
SC-15-12J-MI	15.0	1.2000 <sup>2</sup>	6.2	60.0	1.60	E (120°C)	45.2
SC-15-E37J	15.0	3.7000 <sup>2</sup>	16.0	92.0	1.50	E (120°C)	82.4
SC-18-05J	18.0	0.5000 <sup>4</sup>	7.0	50.0	1.80	A (105°C)	60.0
SC-18-085J	18.0	0.8500 <sup>2</sup>	6.0	75.0	1.60	E (120°C)	45.0
SC-18-095J	18.0	0.9500 <sup>2</sup>	5.5	56.0	1.70	E (120°C)	45.0
SC-18-E12J	18.0	1.2000 <sup>2</sup>	9.0	65.0	1.70	E (120°C)	110.0
SC-18-E15J	18.0	1.5000 <sup>2</sup>	8.0	60.0	1.70	E (120°C)	80.0
SC-18-25J	18.0	2.5000 <sup>2</sup>	10.0	60.0	1.70	E (120°C)	77.0
SC-20-01J-A	20.0	0.1500 <sup>1</sup>	4.0	50.0	1.80	E (120°C)	39.6
SC-20-03J	20.0	0.3000 <sup>1</sup>	4.0	50.0	1.80	E (120°C)	39.4
SC-20-05J-P	20.0	0.4875 <sup>4</sup>	3.6	60.0	1.80	E (120°C)	44.2
SC-18-10J	20.0	0.7000 <sup>4</sup>	20.0	72.0	1.70	E (120°C)	45.4
SC-20-E085JM	20.0	1.2000 <sup>2</sup>	6.0	46.0	2.10	E (120°C)	90.0
SC-20-E18J	20.0	1.8000 <sup>2</sup>	6.8	65.0	2.00	E (120°C)	115.0
Part Number	Rated Current (A)	Inductance (mH) Minimum	DC Resistance/Line (mΩ) Maximum	Temperature Rise (K) Maximum	Wire Diameter (mm)	Thermal Class	Weight (g) Approximate

<sup>1</sup> Inductance Measurement Condition: 1 kHz

<sup>2</sup> Inductance Measurement Condition: 10 kHz

<sup>3</sup> Inductance Measurement Condition: 16 kHz

<sup>4</sup> Inductance Measurement Condition: 100 kHz

## Frequency Characteristics





## Frequency Characteristics cont.



## Frequency Characteristics cont.



## Frequency Characteristics cont.



## Frequency Characteristics cont.

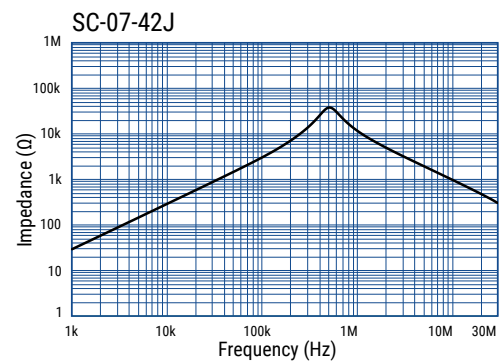
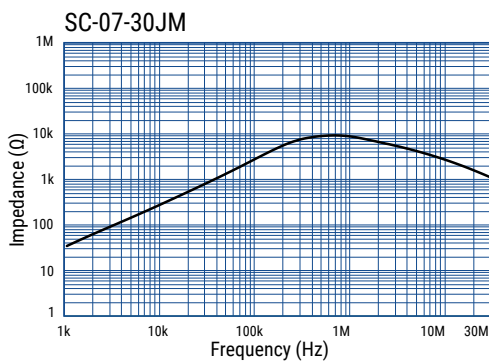

## Frequency Characteristics cont.

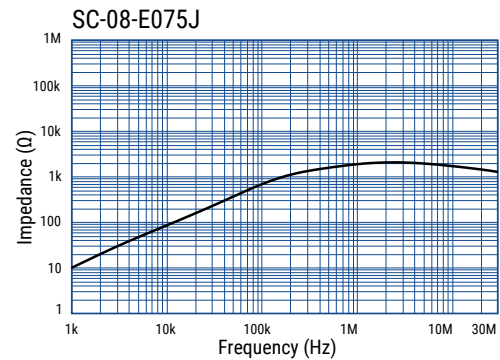
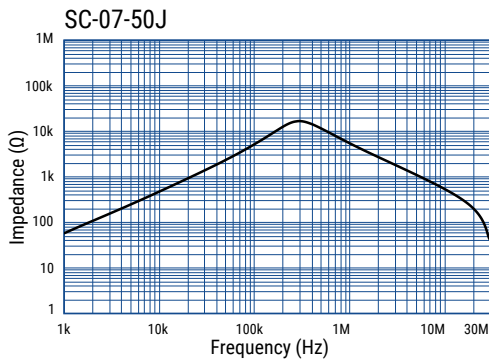
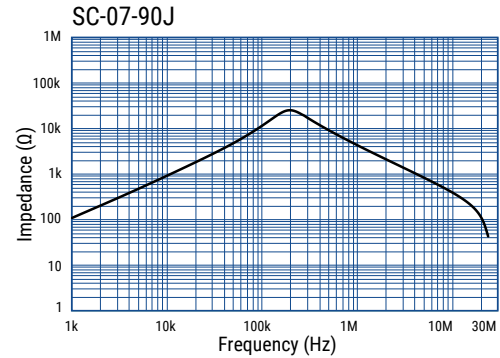
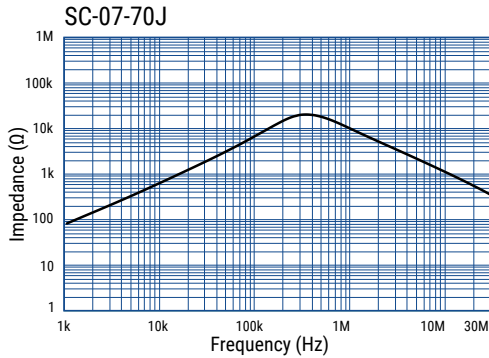

## Frequency Characteristics cont.

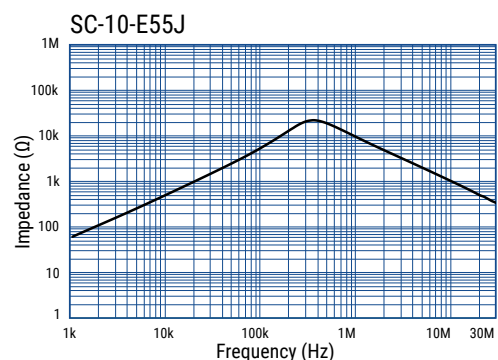
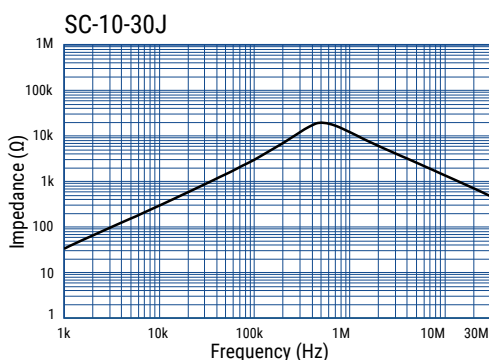
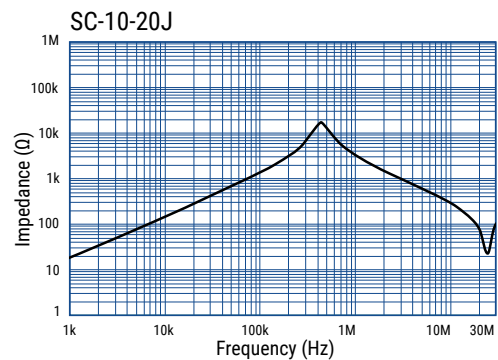
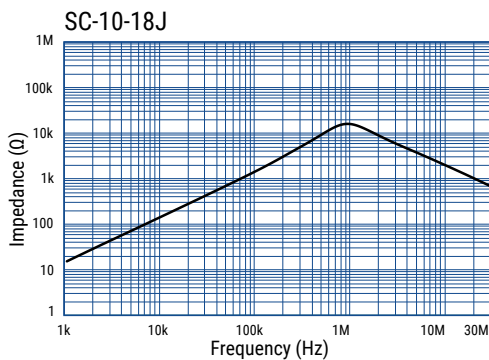
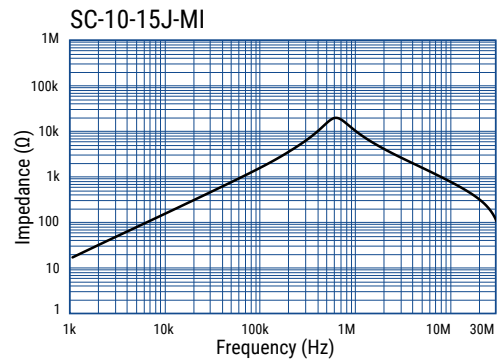
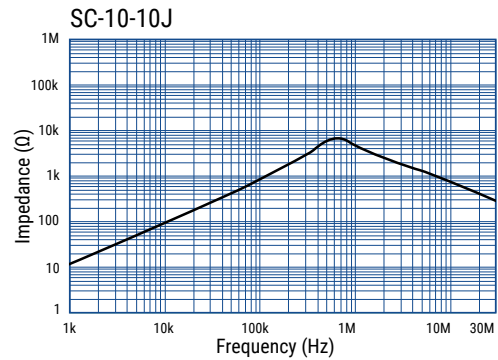
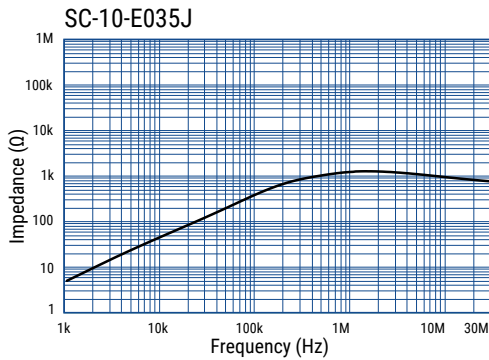

## Frequency Characteristics cont.





## Frequency Characteristics cont.

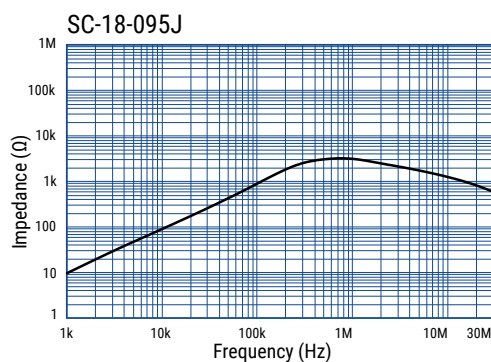
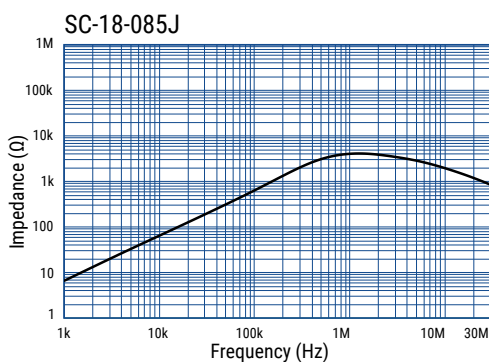
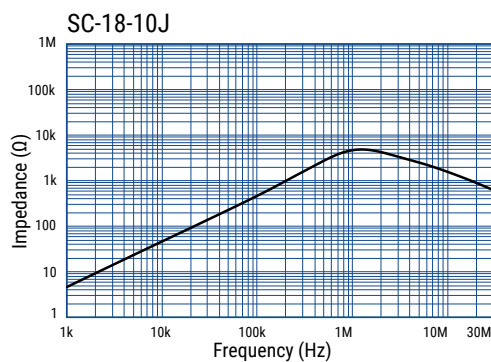
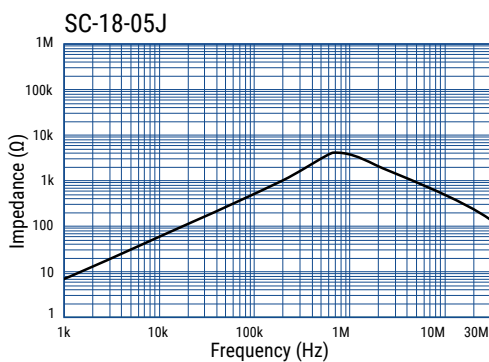
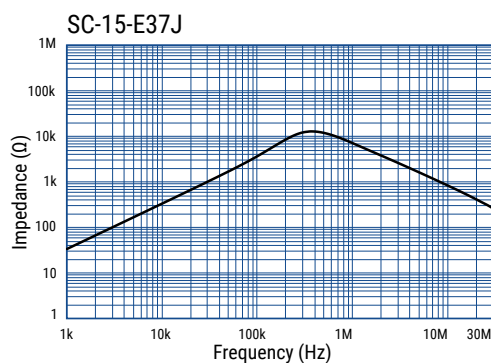
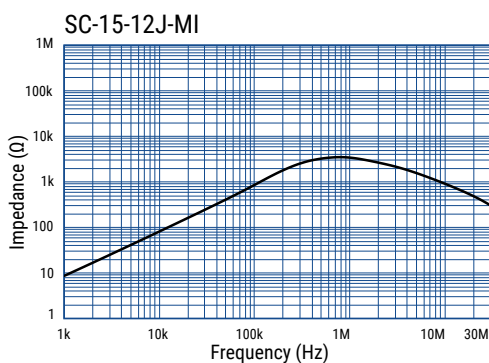
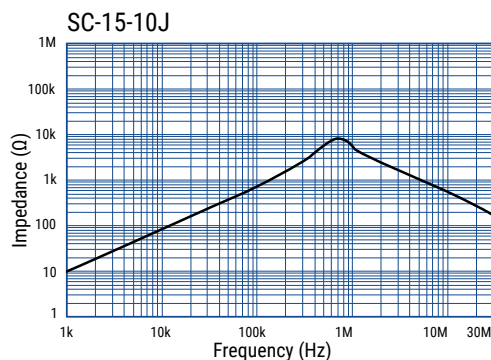
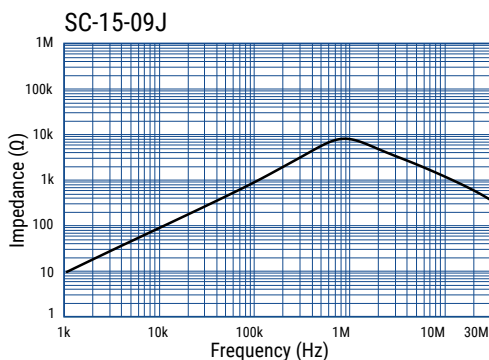



## Frequency Characteristics cont.

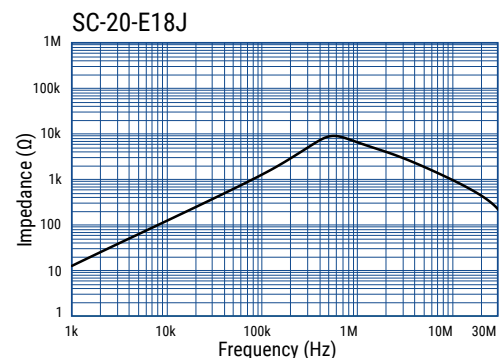
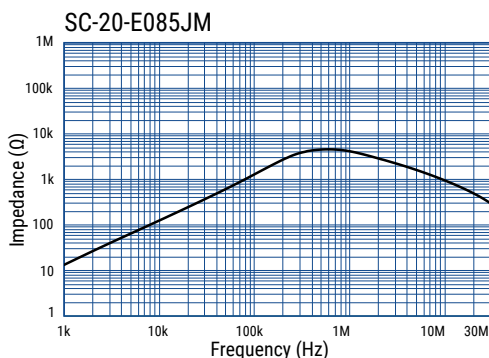
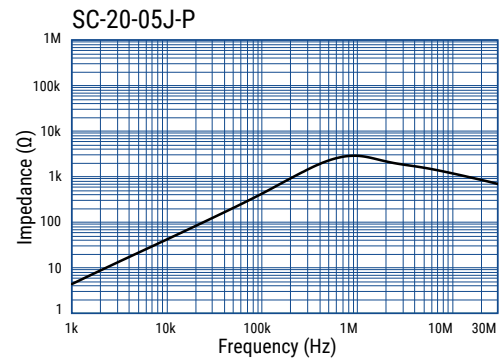
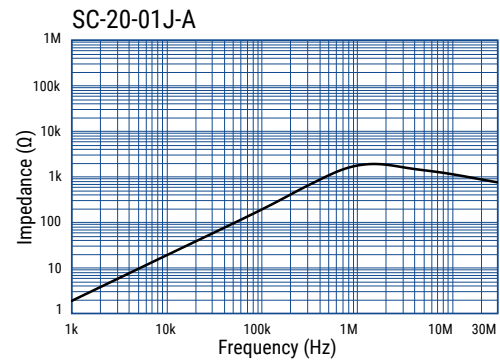
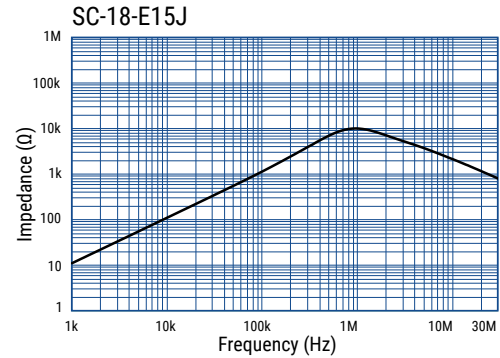

## Packaging

Type	Packaging Type	Pieces Per Box
SC-02-10J	Tray	400
SC-02-20J		
SC-02-30J		
SC-02-50J		
SC-02-70J		
SC-02-100J		
SC-02-E115J		
SC-02-E120J		
SC-02-300J		
SC22-025-290J		
SC-03-28J		
SC-03-30J		
SC-03-55J		
SC-03-67J		
SC-03-85J		
SC-04-20JN		
SC-05-50J		
SC-05-80J		
SC22-04-100J		
SC-04-200J		
SC-04-E17J		
SC-04-E50J		
SC-05-06J		
SC-05-10J		
SC-05-15J		
SC-05-21J		
SC-05-20J		
SC-05-27J		
SC-05-30J		
SC22-05-30J		
SC22-05-70J		
SC-05-100J		
SC-06-10J-B		
SC-06-35J		
SC-06-40J		
SC-06-60J		
SC22-06-60J		
SC-07-10J		
SC-07-30JM		
SC-07-42J		

Type	Packaging Type	Pieces Per Box
SC-07-70J	Tray	200
SC-07-90J		
SC-07-50J		
SC-08-E075J		
SC-08-20J		
SC-08-30J		
SC-08-44J		
SC-08-100JM		
SC-10-E035J		
SC-10-10J		
SC-10-14J		
SC-10-15J-MI		
SC-10-18J		
SC-10-20J		
SC-10-30J		
SC-10-E55J		
SC-11-16J		
SC-11-20J		
SC-12-E035J		
SC-12-15J		
SC-14-12J		
SC-15-02J		
SC-15-05J		
SC-15-07J		
SC-15-09J		
SC-15-10J		
SC-15-12J-MI		
SC-15-E37J		
SC-18-05J		
SC-18-10J		
SC-18-085J		
SC-18-095J		
SC-18-E12J		
SC-18-E15J		
SC-18-25J		
SC-20-01J-A		
SC-20-03J		
SC-20-05J-P		
SC-20-E085JM		
SC-20-E18J		

## Handling Precautions

### Precautions for product storage

AC Line Filters should be stored in normal working environments. While the chokes themselves are quite robust in other environments, solderability will be degraded by exposure to high temperatures, high humidity, corrosive atmospheres, and long term storage.

KEMET recommends that maximum storage temperature not exceed 40°C and maximum storage humidity not exceed 70% relative humidity. Atmospheres should be free of chlorine and sulfur bearing compounds. Temperature fluctuations should be minimized to avoid condensation on the parts. Avoid storage near strong magnetic fields, as this might magnetize the product.

For optimized solderability, AC line filters stock should be used promptly and preferably within 6 months of receipt.

### Product temperature rise values

The values listed for temperature rise are the result of self-heating in wires when the rated current (commercial frequency) is applied.

When using the product, check and evaluate the value of the core temperature rise under actual operating conditions.

## KEMET Electronics Corporation Sales Offices

For a complete list of our global sales offices, please visit [www.kemet.com/sales](http://www.kemet.com/sales).

---

### Disclaimer

All product specifications, statements, information and data (collectively, the "Information") in this datasheet are subject to change. The customer is responsible for checking and verifying the extent to which the Information contained in this publication is applicable to an order at the time the order is placed. All Information given herein is believed to be accurate and reliable, but it is presented without guarantee, warranty, or responsibility of any kind, expressed or implied.

Statements of suitability for certain applications are based on KEMET Electronics Corporation's ("KEMET") knowledge of typical operating conditions for such applications, but are not intended to constitute – and KEMET specifically disclaims – any warranty concerning suitability for a specific customer application or use. The Information is intended for use only by customers who have the requisite experience and capability to determine the correct products for their application. Any technical advice inferred from this Information or otherwise provided by KEMET with reference to the use of KEMET's products is given gratis, and KEMET assumes no obligation or liability for the advice given or results obtained.

Although KEMET designs and manufactures its products to the most stringent quality and safety standards, given the current state of the art, isolated component failures may still occur. Accordingly, customer applications which require a high degree of reliability or safety should employ suitable designs or other safeguards (such as installation of protective circuitry or redundancies) in order to ensure that the failure of an electrical component does not result in a risk of personal injury or property damage.

Although all product-related warnings, cautions and notes must be observed, the customer should not assume that all safety measures are indicated or that other measures may not be required.

When providing KEMET products and technologies contained herein to other countries, the customer must abide by the procedures and provisions stipulated in all applicable export laws and regulations, including without limitation the International Traffic in Arms Regulations (ITAR), the US Export Administration Regulations (EAR) and the Japan Foreign Exchange and Foreign Trade Act.

*KEMET is a registered trademark of KEMET Electronics Corporation.*