

LXP2-RS

~9.6° spot beam optimized for CREE XP-E. 14.7 mm high assembly with installation tape.

TECHNICAL SPECIFICATIONS:

Dimensions	Ø 21.6 mm
Height	14.7 mm
Fastening	tape
ROHS compliant	yes ⓘ

MATERIAL SPECIFICATIONS:

Component	Type	Material	Colour	Finish
LXP2-RS	Single lens	PMMA	clear	
LXP2-LH1-TAPE-BLK	Holder	PC	black	
HEIDI-TAPE	Tape	PU tape	black	



ORDERING INFORMATION:

Component		Qty in box	MOQ	MPQ	Box weight (kg)
CA11481_LXP2-RS	Single lens	1680	336	112	9.5
» Box size: 480 x 280 x 300 mm					

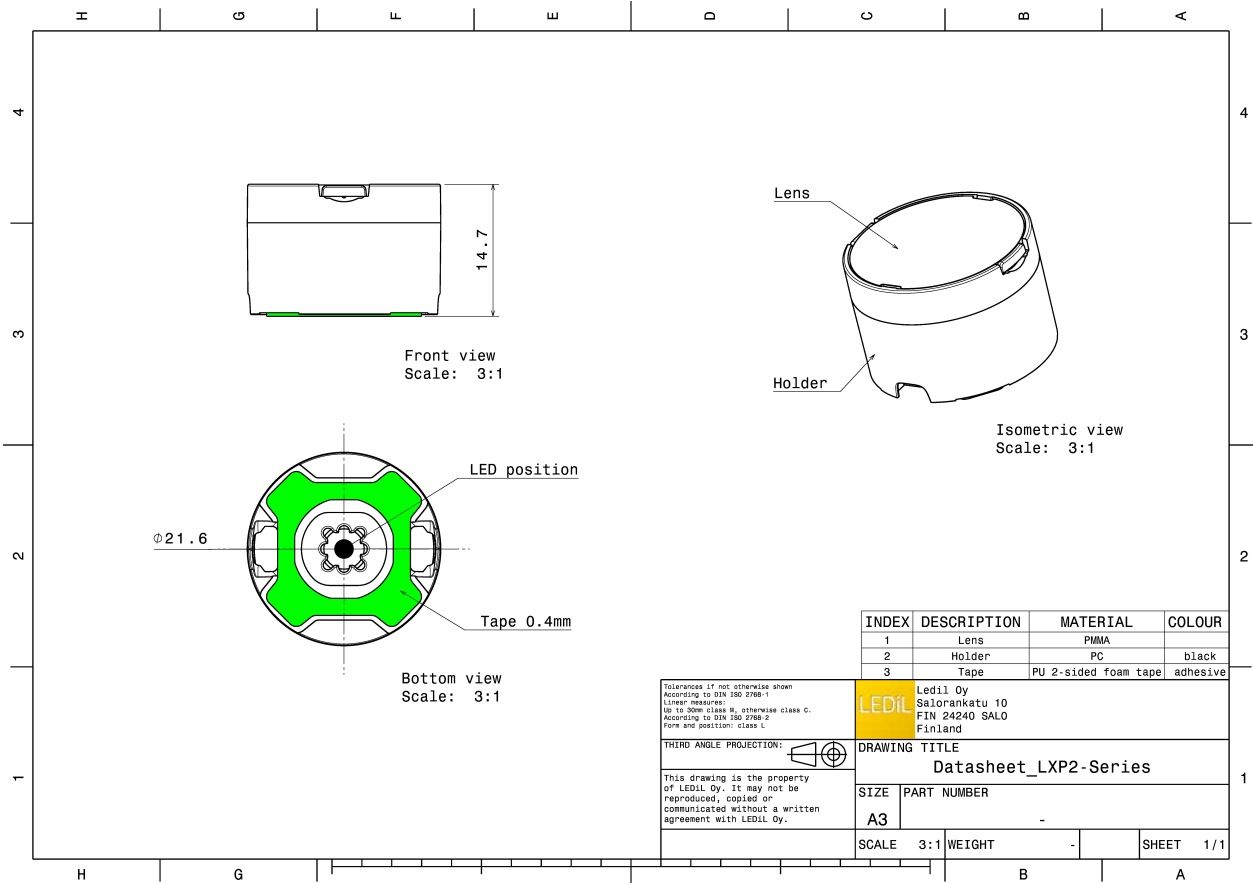

PHOTOMETRIC DATA (MEASURED):



LED XP-E
 FWHM 7.0°
 Efficiency 94 %
 LEDs/each optic 1
 Light colour White
 Required components:

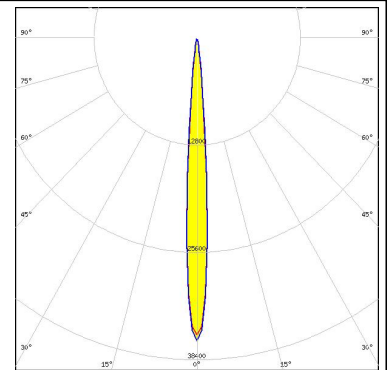

LED XP-E2
 FWHM 8.0°
 Efficiency 90 %
 Peak intensity 44 cd/lm
 LEDs/each optic 1
 Light colour White
 Required components:

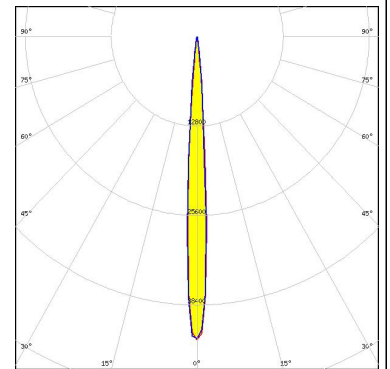
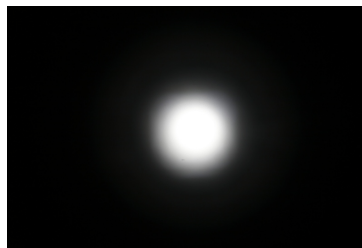

LED XP-G
 FWHM 10.0°
 Efficiency 94 %
 LEDs/each optic 1
 Light colour White
 Required components:

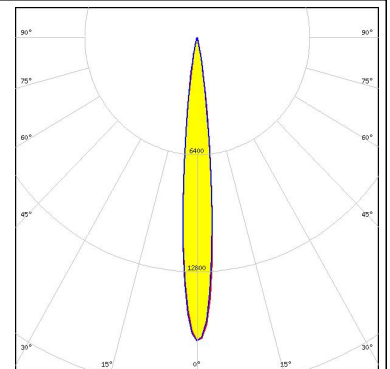

LED XP-G2
 FWHM 10.0°
 Efficiency 94 %
 Peak intensity 21 cd/lm
 LEDs/each optic 1
 Light colour White
 Required components:

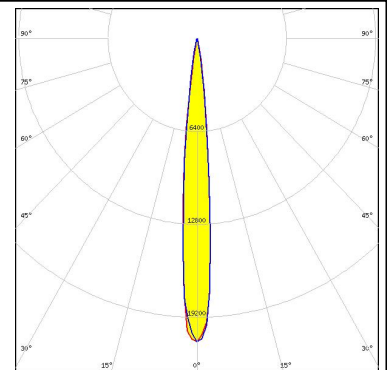
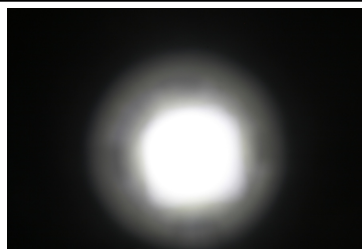

PHOTOMETRIC DATA (MEASURED):



LED XP-L HI
 FWHM 10.0°
 Efficiency 89 %
 Peak intensity 20 cd/lm
 LEDs/each optic 1
 Light colour White
 Required components:

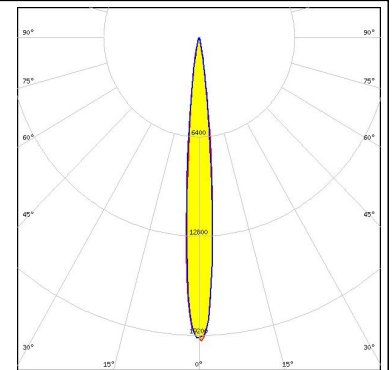
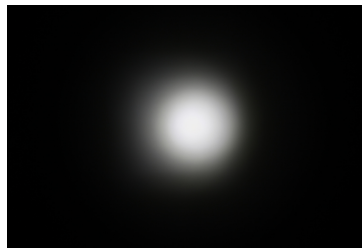

LED H35C1 (LEMWA33)
 FWHM 11.0°
 Efficiency 88 %
 Peak intensity 18.2 cd/lm
 LEDs/each optic 1
 Light colour White
 Required components:

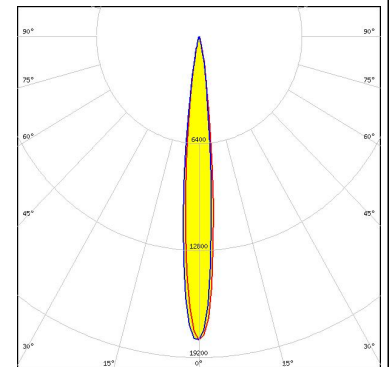
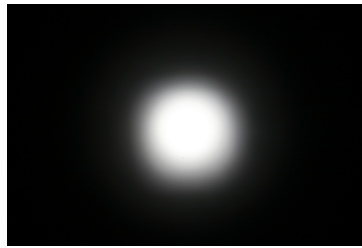

LED NCSxx19A
 FWHM 8.0°
 Efficiency 86 %
 Peak intensity 26.4 cd/lm
 LEDs/each optic 1
 Light colour White
 Required components:

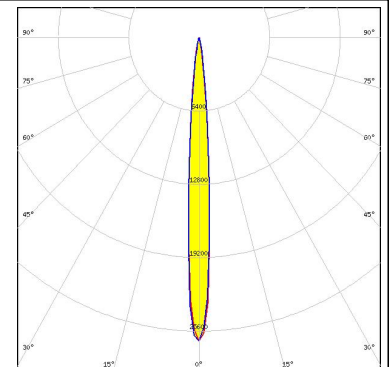
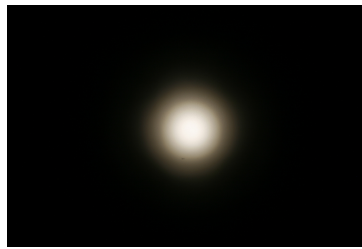

LED NVSW219D
 FWHM 12.0°
 Efficiency 92 %
 Peak intensity 14.7 cd/lm
 LEDs/each optic 1
 Light colour White
 Required components:

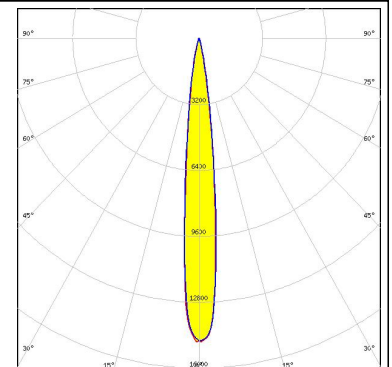

PHOTOMETRIC DATA (MEASURED):



LED NVSW3x9A
FWHM 12.0°
Efficiency 83 %
Peak intensity 10.2 cd/lm
LEDs/each optic 1
Light colour White
Required components:

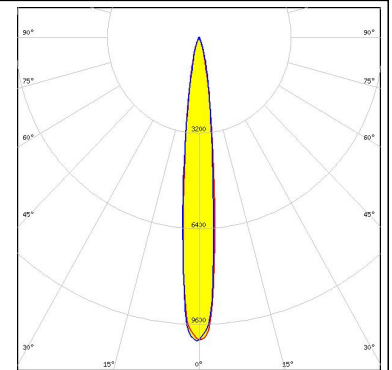

LED NVSxx19B/NVSxx19C
FWHM 11.0°
Efficiency 89 %
Peak intensity 13.5 cd/lm
LEDs/each optic 1
Light colour White
Required components:

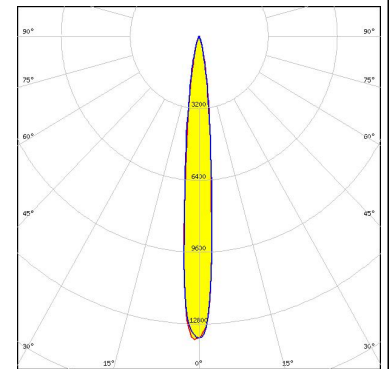

PHOTOMETRIC DATA (SIMULATED):



LED LUXEON V2
FWHM 12.0°
Efficiency 92 %
Peak intensity 16.7 cd/lm
LEDs/each optic 1
Light colour White
Required components:

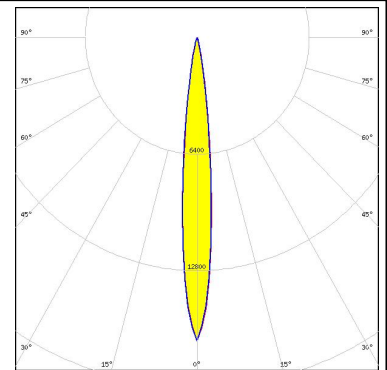

LED LM301B
FWHM 9.0°
Efficiency 94 %
Peak intensity 21.7 cd/lm
LEDs/each optic 1
Light colour White
Required components:



LED Z5
FWHM 10.0°
Efficiency %
LEDs/each optic 1
Light colour White
Required components:



LED Z8Y22P
FWHM 12.0°
Efficiency 92 %
Peak intensity 13.4 cd/lm
LEDs/each optic 1
Light colour White
Required components:

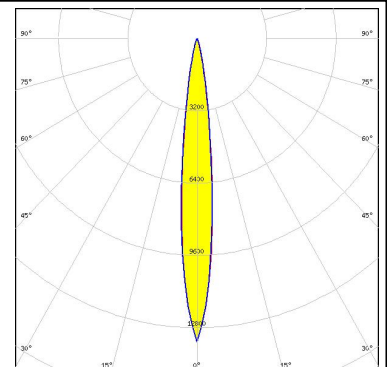

GENERAL INFORMATION:

NOTE: The typical beam angle will be changed by different color, chip size and chip position tolerance. The typical total beam angle is the full angle measured where the luminous intensity is half of the peak value.

MATERIALS:

As part of our continuous research and improvement processes, and to ensure the best possible quality and availability of our products, LEDiL reserves the right to change material grades without notice.

PRODUCT DATA USER AGREEMENT AND DISCLAIMER:

The measured data in the provided downloadable LEDiL Product Datasheets and Mechanical 2D-Drawings is rounded and provided as reference for planning. LEDiL Oy's optical specifications have been verified by conducting performance testing of the products in accordance with the company's quality system. The reported data are averaged results of multiple measurements with typical variation. LEDiL Oy reserves the right to without prior notification make changes and improvements to its products.

LEDiL Oy assumes neither warranty, nor guarantee nor any other liability of any kind for the contents and correctness of the provided data. The provided data has been generated with highest diligence but the provided data may in reality not represent the complete possible variation range of all intrinsic parameters. Therefore, in certain cases a deviation from the provided data could occur.

LEDiL Oy reserves the right to undertake technical changes of its products without further notification which could lead to changes in the provided data. LEDiL Oy assumes no liability of any kind for the possible deviation from any provided data or any other damage resulting from the usage of the provided data.

The user agrees to this disclaimer and user agreement with the download or usage of the provided files.

LEDiL Oy

Joensuunkatu 13
FI-24240 SALO
Finland

LEDiL Inc.

228 West Page Street
Suite D
Sycamore IL 60178
USA

Local sales and technical support

[www.ledil.com/
where_to_buy](http://www.ledil.com/where_to_buy)

Shipping locations

Salo, Finland
Hong Kong, China

Distribution Partners

[www.ledil.com/
where_to_buy](http://www.ledil.com/where_to_buy)