

QUICK START GUIDE FOR DEMONSTRATION CIRCUIT 1320A HIGH POWER DENSITY STEP-DOWN CONVERTER

LTCC3608/9EWKG

DESCRIPTION

Demonstration circuit 1320A is a high power density step-down DC/DC converter featuring LTC3608EWKG/LTC3609EWKG high current, high input voltage monolithic DC/DC step-down converter. The input voltage of the demo board is from 5V to 20V for DC1320A-A with LTC3608EWKG and 5V to 28V for DC1320A-B with LTC3609EWKG. The output voltage is jumper-selectable [1.5V/1.8V/2.5V/3.3V@8A](#). The converter provides the main output with high efficiency, high power density and fast transient based on constant on-time valley current mode control.

The converter can be configured for discontinuous or forced continuous operation at light load. The converter switching frequency is compensated for variations in V_{in} and V_{out} . The LTC3608/9EWKG is in a compact 7mm X 8mm QFN package.

Design files for this circuit board are available. Call the LTC factory.

 , LTC and LT are registered trademarks of Linear Technology Corporation.

Table 1. Performance Summary ($T_A = 25^\circ\text{C}$)

PARAMETER	CONDITION	VALUE	
Input Voltage	Typical	5V-20V for DC1320A-A 5V-28V for DC1320A-B	
Output Voltage V_{OUT}	$I_{OUT} = 0\text{A to } 8\text{A}$	1.5V/1.8V/2.5V/3.3V $\pm 2\%$	
Maximum Output Current	$V_{IN} = 5\text{V-}20\text{V (DC1320A-A)}$	8A	
	$V_{IN} = 5\text{V-}28\text{V (DC1320A-B)}$	8A	
Nominal switching frequency	$V_{in}=5\text{V-}28\text{V}$, $V_{out}=1.5\text{V}/1.8\text{V}/2.5\text{V}/3.3\text{V}$, $I_{out}=0\text{-}8\text{A}$	500kHz-700kHz	
Full Load Efficiency	DC1320A-A	$V_{IN} = 5\text{V}$, $V_{OUT1} = 1.8\text{V}$, $I_{OUT1} = 8\text{A}$	89% Typical
		$V_{IN} = 12\text{V}$, $V_{OUT1} = 1.8\text{V}$, $I_{OUT1} = 8\text{A}$	87.5% Typical
		$V_{IN} = 20\text{V}$, $V_{OUT1} = 1.8\text{V}$, $I_{OUT1} = 8\text{A}$	85.5% Typical
	DC1320A-B	$V_{IN} = 5\text{V}$, $V_{OUT2} = 1.8\text{V}$, $I_{OUT2} = 8\text{A}$	87.5% Typical
		$V_{IN} = 12\text{V}$, $V_{OUT1} = 1.8\text{V}$, $I_{OUT1} = 8\text{A}$	83.2% Typical
		$V_{IN} = 24\text{V}$, $V_{OUT1} = 1.8\text{V}$, $I_{OUT1} = 8\text{A}$	82.2% Typical

QUICK START PROCEDURE

Demonstration circuit 1320 is easy to set up to evaluate the performance of the LTC3608/9EWKG. Refer to **Figure 1 for proper measurement equipment setup** and follow the procedure below:

NOTE: When measuring the input or output voltage ripple, care must be taken to avoid a long

1. With power off, connect the input power supply to VIN and GND. Connect the load between VOUT1, VOUT2 and GND. Preset the load current at 0A (minimum). Refer to Figure 1 for correct test set up. The RUN/SS1 and RUN/SS2 jumpers should be at “on” position.

2. Turn on the input power.

NOTE: Make sure that the input voltage does not exceed 20V for A-A and 28V for A-B.

3. Check for the proper output voltages:

$V_{out}=1.8V, +/-2\%$

ground lead on the oscilloscope probe. Measure the input or output voltage ripple by touching the probe tip directly across the Vin or Vout and GND terminals. See Figure 2 for proper scope probe technique.

NOTE: If there is no output, temporarily disconnect the load to make sure that the load is not set too high.

4. Once the proper output voltages are established, adjust the loads within the operating range and observe the output voltage regulation, ripple voltage, efficiency and other parameters.

5. The output voltage can be programmed to other voltages 1.5V/2.5V/3.3V by selecting jumper. The output voltage deviations should be within +/- 2% of nominal voltages.

6. Typical efficiency curves are shown in Figure 3, Figure 4 and Figure 5.

QUICK START GUIDE FOR DEMONSTRATION CIRCUIT 1320A HIGH POWER DENSITY STEP-DOWN CONVERTER

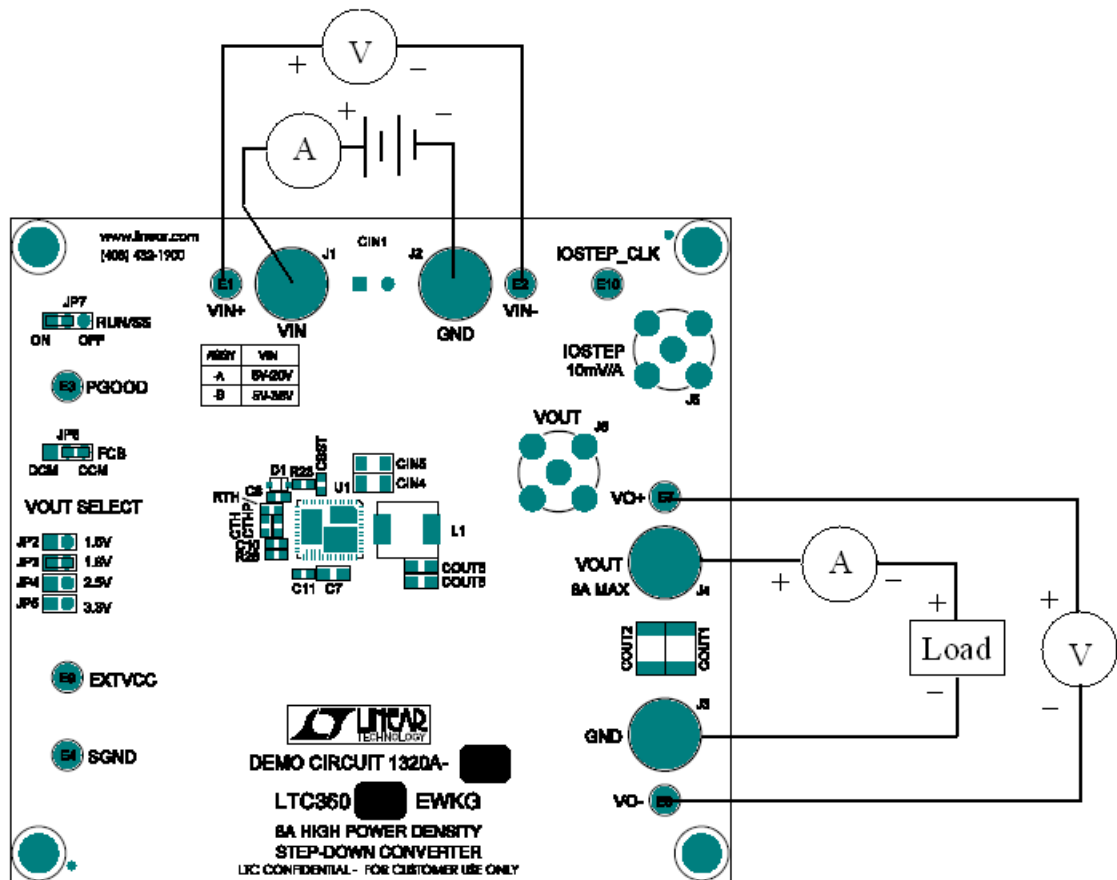

Figure 1. Proper Measurement Equipment Setup

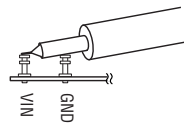

Figure 2. Measuring Input or Output Ripple

QUICK START GUIDE FOR DEMONSTRATION CIRCUIT 1320A HIGH POWER DENSITY STEP-DOWN CONVERTER

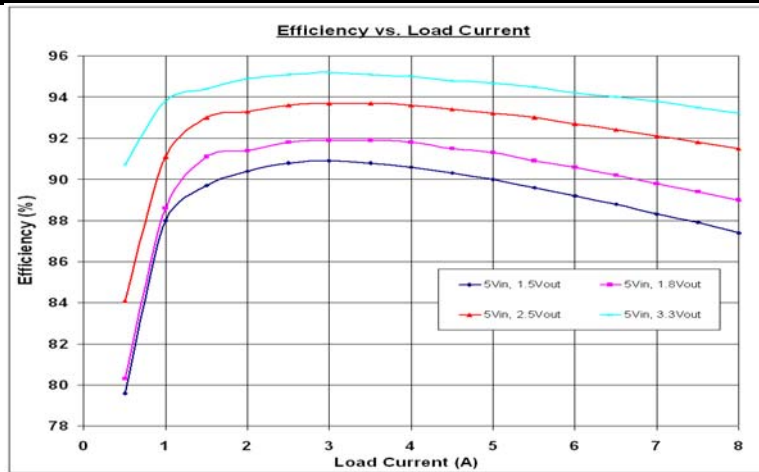

Figure 3. Typical Supply Efficiency vs Load Current of DC1320A-A at Vin=5V

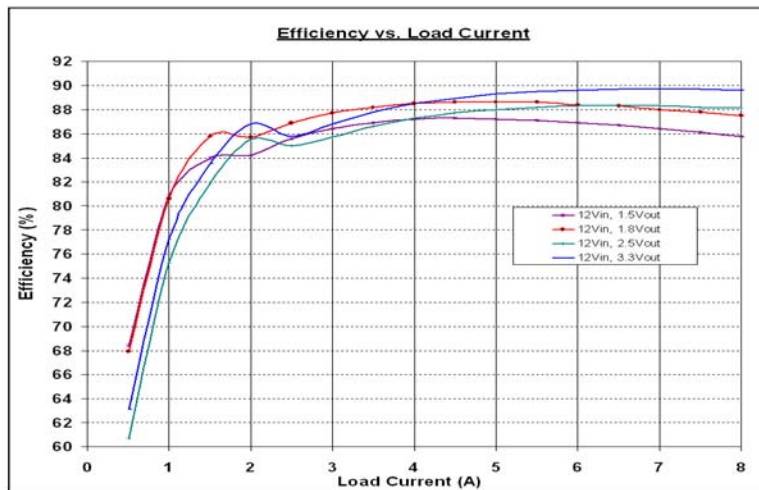

Figure 4. Typical Supply Efficiency vs Load Current of DC1320A-A at Vin=12V

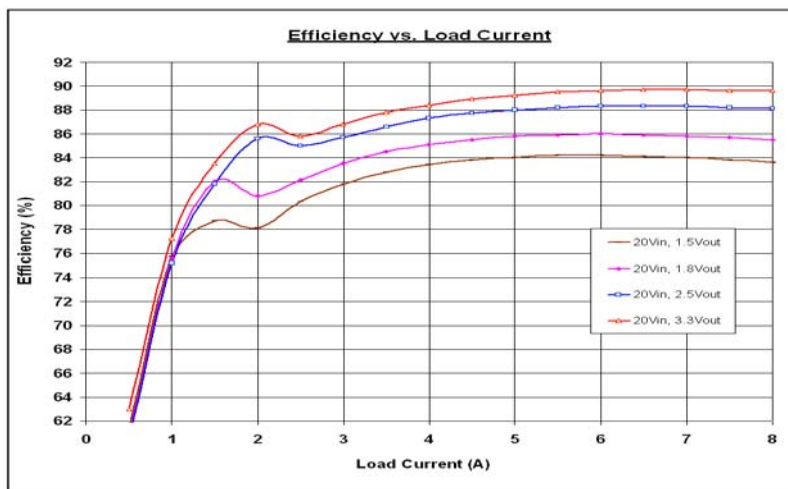
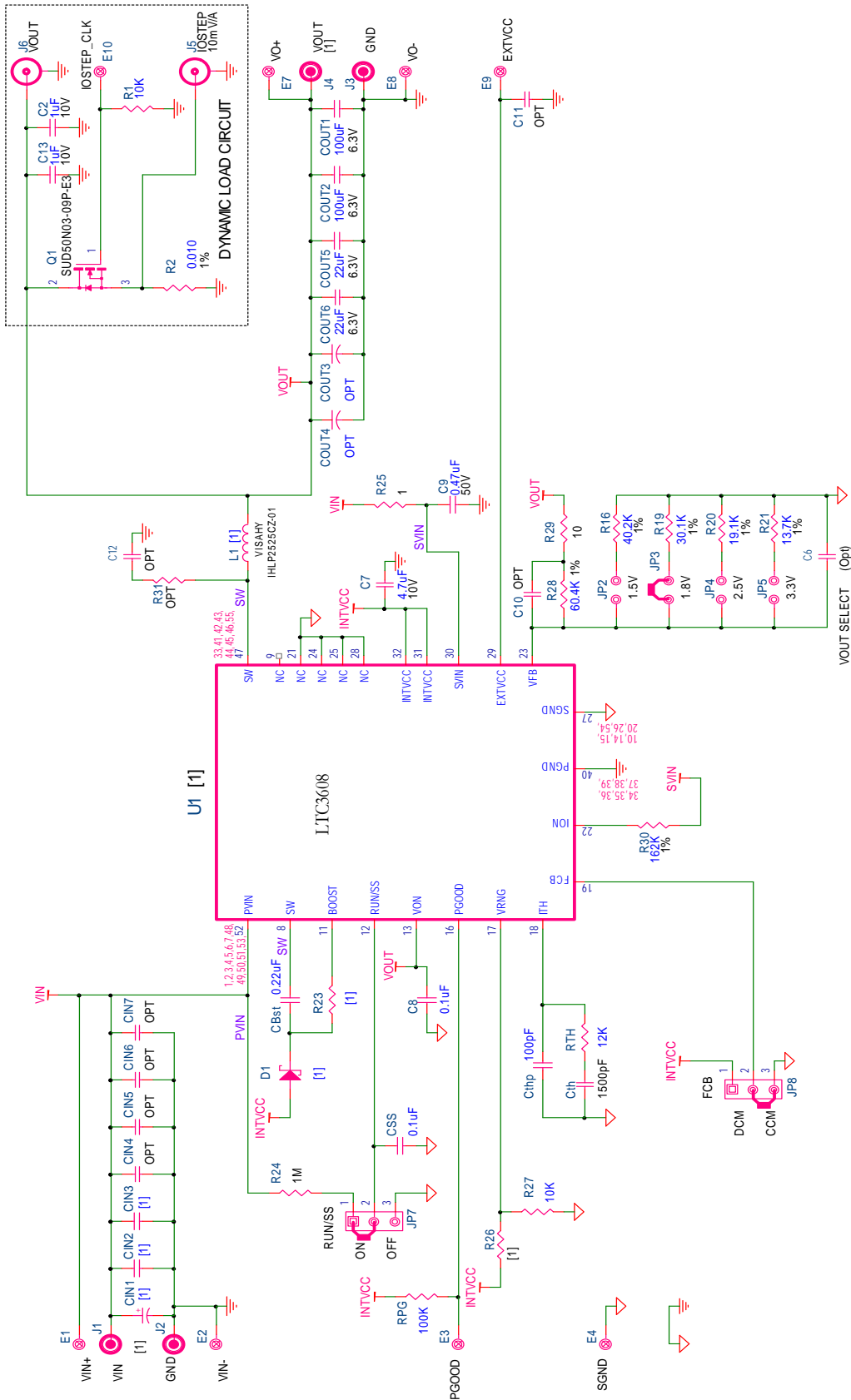

Figure 5. Typical Supply Efficiency vs Load Current of DC1320A-A at Vin=20V

QUICK START GUIDE FOR DEMONSTRATION CIRCUIT 1320A

HIGH POWER DENSITY STEP-DOWN CONVERTER



[1]

ASSY	VIN	VOUT	D1	CIN1	CIN2, CIN3	U1	R23	L1
- A	5V - 20V	8A MAX	CMDBS-3	1500µF, 35V	10µF, 35V	LTC3608EW/KG	OPT	1.00µH
- B	9V - 32V	6A MAX	SDM10K45	1000µF, 50V	10µF, 50V	LTC3609EW/KGHV	35.7K	1.5µH