

# PolySwitch Resettable Devices

## Telecommunications and Networking Devices

The PolySwitch families of telecommunications and networking devices help meet the growing demand for resettable overcurrent protection. These product families help provide protection against damage caused by power cross and power induction surges as defined in ITU, Telcordia GR1089 and UL60950. Available in chip, surface-mount and radial-leaded configurations, TE's PolySwitch devices help improve the reliability of customer premise and network equipment worldwide.

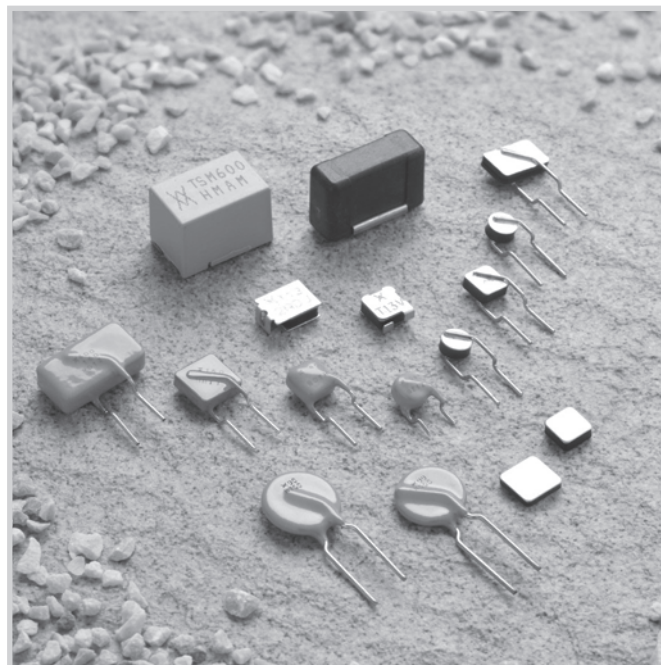

### Benefits

- Many product choices give engineers help increase design flexibility
- Compatible with high-volume electronics assembly
- Assist in meeting regulatory equipment requirements
- Help improve line balance
- Applicable for legacy POTS and modern digital communications equipment

### Features

- RoHS compliant
- Resettable overcurrent protection
- Surface-mount, radial-leaded and chip form factors
- Fast time-to-trip
- Agency recognition: UL, CSA, TÜV
- Resistance-sorted and matched devices available
- Low parasitic capacitance/flat impedance with frequency

### Applications

- |                      |                                 |   |
|----------------------|---------------------------------|---|
| • Modems             | • PBX systems                   | • Powered ethernet systems                      |
| • Phone sets         | • MDF modules                   | • VoIP (Voice over Internet Protocol) equipment |
| • Fax machines       | • Analog and digital line cards | • LAN, WAN equipment                            |
| • Phone wall outlets | • T1/E1 equipment               | • Customer premise equipment                    |
| • Alarm systems      | • xDSL modems and splitters     | • Access network hardware                       |

## Application Guide for PolySwitch Telecommunications and Networking Devices\*

To use this guide, follow the steps below:

1. Select your equipment type from the guide below.
2. Select the type of protection depending on the agency and regional specifications in the second column.
3. Select the form factor for your application.
4. Use the Agency Specification/ PolySwitch Device Selection Guide on the next page to select a specific part number for each application based on the agency requirements.
5. Parts with fast time-to-trip or low resistance are available. Please consult a TE Circuit Protection representative.

| Application   | Region/<br>Specification   | Overcurrent Protection |               |             |
|---|--|------------------------|---------------|-------------|
|   |  | Form Factor            |               |             |
|   |  | Radial-leaded          | Surface-mount | Chip        |
| <b>Customer Premise equipment<br/>IT equipment</b><br>Analog Modems, V.90 Modems,<br>ISDN Modems, xDSL Modems,<br>ADSL Splitters, Phone Sets, Fax Machines,<br>Answering Machines, Caller ID, Internet<br>Appliances, PBX Systems, POS Terminals,<br>Wall Plugs | <b>North America</b><br>TIA-968-A,<br>UL 60950,<br>GR1089 Port Type 3 <sup>†</sup>         | TRF600-150             | TS600-170F    |             |
|   |  | TR600-150F-EX          | TS600-200F    |             |
|   |  | TRF600-160             | TSM600-250F   |             |
|   |  | TRF600-250             | TSM600-400F   |             |
|   | <b>Europe/Asia/<br/>South America</b><br>ITU K.21  | TRF250-120             | TS250-130F    |             |
|   |  | TRF250-120T            | TSV250-130F   |             |
|   |  | TRF250-145             | TSV250-184F   |             |
|   |  | TRF250-183             |               |             |
|   |  | TRF250-184             |               |             |
|   |  |                        |               |             |
| <b>Access network equipment (†)</b><br>Remote Terminals, Line Repeaters,<br>Multiplexers, Cross-Connects,<br>WAN Equipment  | <b>North America</b><br>GR1089 Port Type 5 <sup>†</sup>                                    | TRF600-160             | TS600-170F    |             |
|   |  | TRF600-250             | TS600-200F    |             |
|   |  | TRF600-400             | TS600-400F    |             |
|   |  |                        | TSM600-250F   |             |
|   | <b>Europe/Asia/<br/>South America</b><br>ITU K.45  |                        | TSM600-400F   |             |
|   |  |                        | FT600-1250**  |             |
|   |  | TRF250-120             | TS250-130F    |             |
|   |  | TRF250-120T            | TSV250-130F   |             |
|   |  | TRF250-145             | TSV250-184F   |             |
|   |  | TRF250-183             |               |             |
| <b>Central office switching equipment (†)</b><br>Analog/POTS Linecards, ISDN Linecards,<br>xDSL Modems, ADSL/VDSL Splitters,<br>T1/E1 Linecards, Multiplexers,<br>CSU/DSU, Servers  | <b>North America</b><br>GR1089 Port Type 1 <sup>†</sup>                                    | TRF600-160             | TS600-170F    |             |
|   |  | TRF600-250             | TS600-200F    |             |
|   |  | TRF600-400             | TS600-400F    |             |
|   |  |                        | TSM600-250F   |             |
|   | <b>Europe/Asia/<br/>South America</b><br>ITU K.20  |                        | TSM600-400F   |             |
|   |  |                        | FT600-1250**  |             |
|   |  | TRF250-120             | TS250-130F    | TCF250-180  |
|   |  | TRF250-120T            | TSV250-130F   |             |
|   |  | TRF250-145             | TSV250-184F   |             |
|   |  | TRF250-183             |               |             |
| <b>Primary protection modules (†)</b><br>MDF modules, Network Interface<br>Devices (NID)  | <b>North America</b><br>Telcordia GR-974   | TRF250-183             | TSV250-184F   |             |
|   |  | TRF250-184             |               |             |
|   | <b>Europe/Asia/<br/>South America</b><br>ITU K.20  | TRF250-055UT           | TSL250-080F   | TCF250-100T |
|   |  | TRF250-080U            | TS250-130F    | TCF250-120T |
|   |  | TRF250-110U            | TSV250-130F   | TCF250-145T |
|   |  | TRF250-120             | TSV250-184F   | TCF250-180  |
|   |  | TRF250-120T            |               |             |
|   |  | TRF250-145             |               |             |
|   |  | TRF250-183             |               |             |
|   |  | TRF250-184             |               |             |
| <b>Short-haul/intrabuilding communications<br/>equipment (†)</b><br>LAN Equipment, VoIP Cards, Cable<br>Telephony NIUs, Wireless Local Loop<br>Handsets   | <b>North America</b><br>GR1089 Port Type 2 <sup>†</sup><br>GR1089 Port Type 4 <sup>†</sup> | TRF250-080U            | TSL250-080F   |             |
|   |  | TRF250-120             | TS250-130F    |             |
|   |  | TRF250-120T            | TSV250-130F   |             |
|   |  | TRF250-145             | TSV250-184F   |             |
|   | <b>Europe/Asia/<br/>South America</b><br>ITU K.21  | TRF250-183             |               |             |
|   |  | TRF250-184             |               |             |
|   |  | TRF250-120             | TS250-130F    |             |
|   |  | TRF250-120T            | TSV250-130F   |             |
|   |  | TRF250-145             | TSV250-184F   |             |
|   |  | TRF250-183             |               |             |
| TSV250-184  |  |                        |               |             |

\* Applies to all products which share the same prefix. † Tested with 230V gas discharge tube primary protector.

**Protection Application Guide for PolySwitch Telecommunications and Networking Devices\*** Cont'd

| Application  | Region/<br>Specification                                | Overcurrent Protection |                                 |      |
|--|---|------------------------|---------------------------------|------|
|  |   | Form Factor            |                                 |      |
|  |   | Radial-leaded          | Surface-mount                   | Chip |
| <b>LAN Intra-building Power Cross Protection</b><br>LAN Equipment, VoIP Cards, IP Phones   | <b>North America</b><br>GR1089 Port Type 4 <sup>†</sup> | TSL250-080U            | TSL250-080F                     |      |
|  |   | TRF250-120             | TS250-130F                      |      |
|  |   | TRF250-120T            | TSV250-130F                     |      |
|  |   | TRF250-145             | TSV250-184F                     |      |
|  |   | TRF250-183             |                                 |      |
|  |   | TRF250-184             |                                 |      |
| <b>IEEE 802.3AF/AT Power over Ethernet protection</b><br>Powered Ethernet Switches and Terminals,<br>IP phones, Wireless LAN Base Stations,<br>Microcellular Base Stations, VoIP Cards |   |                        | decaSMDC050F/60-2 <sup>††</sup> |      |

\* This list is not exhaustive. TE Circuit Protection welcomes our customers' input for additional application ideas for PolySwitch resettable devices.  
<sup>†</sup> For improved line balance in these applications, resistance-matched parts are recommended.  
<sup>‡</sup> May require additional impedance or coordination with primary protector.  
<sup>\*\*</sup> FT600-1250 are surface-mount telecom fuse devices. FT600-0500 and FT600-2000 reference also available. See telecom fuses section.  
<sup>††</sup> For details on decaSMDC050F/60-2, see surface-mount devices section.

**Agency Specification/Selection Guide for Telecommunications and Networking Devices**

Use the guide below to select the PolySwitch devices that are typically used in your application. The following pages contain the specifications for the part numbers recommended below. PolySwitch devices assist telecommunication equipment in meeting the applicable protection requirements of these industry specifications. Refer to individual agency specifications for test procedures and circuit schematics. Users should independently evaluate the suitability of and test each product for their application.

| Family             | Product*   | Lightning  | Power Cross/Contact/Induction                     |
|--------------------|--|--|---|
| <b>TCF250</b>      | <b>TCF250-100T</b>                                 | ITU K.20 – 1.0kV 10/700 $\mu$ s                              | PRC YD/T694                                       |
|                    |  | GR-1089 Port Types 2 and 4 – 1st Level                       | ITU K.20/21/45 – 0.2A <sup>2</sup> s              |
|                    |  |  | ITU K.20/21/45 – 1A <sup>2</sup> s <sup>†</sup>   |
|                    |  | GR-1089 Port Type 4 – 120V <sub>AC</sub> , 25A <sub>sc</sub> |   |
|                    | <b>TCF250-120T</b>                                 | ITU K.20/21/45 – 1.5kV 10/700 $\mu$ s                        | ITU K.20/21/45 – 230V <sub>AC</sub> , 10 $\Omega$ |
| <b>TCF250-145T</b> | ITU K.20/21/45 – 4.0kV 10/700 $\mu$ s <sup>†</sup> | ITU K.20/21/45 – 0.2A <sup>2</sup> s                         |   |
| <b>TCF250-180</b>  | GR-1089 Port Types 2 and 4 – 1st Level             | ITU K.20/21/45 – 1A <sup>2</sup> s <sup>†</sup>              |   |
|                    |  | ITU K.20/21/45 – 10A <sup>2</sup> s <sup>†</sup>             |   |
|                    |  | GR-1089 Port Type 4 – 120V <sub>AC</sub> , 25A <sub>sc</sub> |   |

\* Applies to all products which share the same prefix.  
<sup>†</sup> Tested with 230V gas discharge tube primary protector.

# Agency Specification/Selection Guide for PolySwitch Telecommunications and Networking Devices

Cont'd

| Family       | Product*               | Lightning   | Power Cross/Contact/Induction  |
|--------------|------------------------|---|--|
| TRF250       | TRF250-055UT           | ITU K.20 – 1.0kV 10/700µs   | ITU K.20 – 230V <sub>AC</sub> , 10Ω  |
|              | TRF250-080U            | ITU K.20 – 1.0kV 10/700µs<br>GR-1089 Port Types 2 and 4 – 1st Level   | ITU K.20 – 230V <sub>AC</sub> , 10Ω<br>ITU K.20 – 0.2A <sup>2</sup> s<br>ITU K.20 – 1A <sup>2</sup> s†<br>GR-1089 Port Type 4 – 120V <sub>AC</sub> , 25Asc   |
|              | TRF250-110U            | ITU K.20/21/45 – 1.5kV 10/700µs   | ITU K.20/21/45 – 230V <sub>AC</sub> , 10Ω  |
|              | TRF250-120             | ITU K.20/21/45 – 4.0kV 10/700µs†  | ITU K.20/21/45 – 0.2A <sup>2</sup> s   |
|              | TRF250-120T            | GR-1089 Port Types 2 and 4 – 1st Level  | ITU K.20/21/45 – 1A <sup>2</sup> s†  |
|              | TRF250-120U            |   | ITU K.20/21/45 – 10A <sup>2</sup> s†   |
|              | TRF250-120UT           |   | GR-1089 Port Type 4 – 120V <sub>AC</sub> , 25Asc   |
|              | TRF250-145             |   |  |
|              | TRF250-145U            |   |  |
|              | TRF250-183             |   |  |
| TRF250-184   |                        | ITU K.20/21/45 – 1.5kV 10/700µs   | ITU K.20/21/45 – 230V <sub>AC</sub> , 10Ω**  |
|              |                        | ITU K.20/21/45 – 4.0kV 10/700µs‡  | ITU K.20/21/45 – 0.2A <sup>2</sup> s   |
|              |                        | GR-1089 Port Types 2 and 4 – 1st Level  | ITU K.20/21/45 – 1A <sup>2</sup> s‡<br>ITU K.20/21/45 – 10A <sup>2</sup> s‡<br>GR-1089 Port Type 4 – 120V <sub>AC</sub> , 25Asc  |
| TS250/TSV250 | TSV250-130F            | ITU K.20/21/45 – 1.5kV 10/700µs   | ITU K.20/21/45 – 230V <sub>AC</sub> , 10Ω  |
|              | TS250-130F             | ITU K.20/21/45 – 4.0kV 10/700µs†<br>GR-1089 Port Types 2 and 4 – 1st Level                                    | ITU K.20/21/45 – 0.2A <sup>2</sup> s<br>ITU K.20/21/45 – 1A <sup>2</sup> s†<br>ITU K.20/21/45 – 10A <sup>2</sup> s†<br>GR-1089 Port Type 4 – 120V <sub>AC</sub> , 25Asc  |
|              | TS250-130F-RB          | ITU K.20/21/45 – 1.5kV 10/700µs<br>ITU K.20/21/45 – 4.0kV 10/700µs‡<br>GR-1089 Port Types 2 and 4 – 1st Level | ITU K.20/21/45 – 230V <sub>AC</sub> , 10Ω<br>ITU K.20/21/45 – 0.2A <sup>2</sup> s<br>ITU K.20/21/45 – 1A <sup>2</sup> s‡<br>ITU K.20/21/45 – 10A <sup>2</sup> s‡<br>GR-1089 Port Type 4 – 120V <sub>AC</sub> , 25Asc |
| TSV250-184F  |                        | ITU K.20/21/45 – 1.5kV 10/700µs   | ITU K.20/21/45 – 230V <sub>AC</sub> , 10Ω**  |
|              |                        | ITU K.20/21/45 – 4.0kV 10/700µs‡  | ITU K.20/21/45 – 0.2A <sup>2</sup> s   |
|              |                        | GR-1089 Port Types 2 and 4 – 1st Level  | ITU K.20/21/45 – 1A <sup>2</sup> s‡<br>ITU K.20/21/45 – 10A <sup>2</sup> s‡<br>GR-1089 Port Type 4 – 120V <sub>AC</sub> , 25Asc  |
| TSL250       | TSL250-080F            | GR-1089 Port Types 2 and 4 – 1st Level  | GR-1089 Port Type 4 – 120V <sub>AC</sub> , 25Asc   |
|              |                        | ITU K.20 – 1.0kV 10/700µs   | ITU K.20/21/45 – 230V <sub>AC</sub> , 10Ω<br>ITU K.20/21/45 – 0.2A <sup>2</sup> s<br>ITU K.20/21/45 – 1A <sup>2</sup> s†   |
| TRF600       | TRF600-150             | TIA-968-A Types A & B   | UL60950 – 600V <sub>AC</sub> , 40Asc   |
|              | TR600-150F-EX          | GR-1089 Port Types 1, 3 and 5 – 1st and 2nd Level††   | UL60950 – 600V <sub>AC</sub> , 40Asc   |
|              | TR600-150F-EX-RA-B-0.5 | GR-1089 Port Types 1, 3 and 5 – 1st and 2nd Level††   | UL60950 – 600V <sub>AC</sub> , 40Asc   |
|              | TRF600-160             | GR-1089 Port Types 1, 3 and 5 – 1st and 2nd Level††   | Telcordia GR-1089 – 600V <sub>AC</sub> , 60Asc   |
|              | TRF600-250             | GR-1089 Port Types 1, 3 and 5 – 1st and 2nd Level††   | Telcordia GR-1089 – 600V <sub>AC</sub> , 60Asc   |
|              | TRF600-400             | GR-1089 Port Types 1, 3 and 5 – 1st and 2nd Level   | Telcordia GR-1089 – 600V <sub>AC</sub> , 60Asc   |
| TS600        | TS600-170F             | TIA-968-A Types A & B   | UL60950 – 600V <sub>AC</sub> , 40Asc   |
|              | TS600-200F-RA          | GR-1089 Port Types 1, 3 and 5 – 1st and 2nd Level††   | Telcordia GR-1089 – 600V <sub>AC</sub> , 60Asc   |
|              | TS600-400F             |   |  |
| TSM600       | TSM600-250F            | TIA-968-A Types A & B   | UL60950 – 600V <sub>AC</sub> , 40Asc   |
|              | TSM600-250F-RA         | GR-1089 Port Types 1, 3 and 5 – 1st and 2nd Level††   | Telcordia GR-1089 – 600V <sub>AC</sub> , 60Asc   |
|              | TSM600-400F            | TIA-968-A Types A & B<br>GR-1089 Port Types 1, 3 and 5 – 1st and 2nd Level                                    | UL60950 – 600V <sub>AC</sub> , 40Asc<br>Telcordia GR-1089 – 600V <sub>AC</sub> , 60Asc   |
| FT600‡‡      | FT600-0500             | TIA-968-A - Types A & B   | UL60950 - 600V <sub>AC</sub> , 40Asc   |
|              | FT600-1250             |   |  |
|              | FT600-2000             | GR-1089 Port Types 1, 3 and 5 – 1st and 2nd Level   | Telcordia GR-1089 – 600V <sub>AC</sub> , 60Asc   |

\* Applies to all products that share the same prefix.

† Tested with 230V gas discharge tube primary protector.

‡ Tested with 350V gas discharge tube primary protector.

\*\* See SCD for additional application fault ratings.

†† May require additional series resistor to help telecommunication equipment pass Surge 3 (1kV, 10/1000µs).

‡‡ See telecom fuses section.

**Table T1 Product Series: Size, Current Rating, Voltage Rating, Typical Resistance for PolySwitch Telecommunications and Networking Devices**

|  | TCF250                          | TRF250                          | TS250                           | TSV250                          | TSL250                   | TS600<br>TSM600                        | TRF600                                 |
|--|---------------------------------|---------------------------------|---------------------------------|---------------------------------|--------------------------|--|--|
| <b>V<sub>MAX</sub> Interrupt (V<sub>AC</sub>)*</b> | 250                             | 250                             | 250                             | 250                             | 250                      | 600                                    | 600                                    |
| <b>Specification</b>                               | ITU<br>GR-1089<br>Ports 2 and 4 | ITU<br>GR-1089<br>Ports 2 and 4 | ITU<br>GR-1089<br>Ports 2 and 4 | ITU<br>GR-1089<br>Ports 2 and 4 | GR-1089<br>Ports 2 and 4 | UL60950<br>GR-1089<br>Ports 1, 3 and 5 | UL60950<br>GR-1089<br>Ports 1, 3 and 5 |
| <b>Hold Current (A)</b>                            |                                 |                                 |                                 |                                 |                          |  |  |
| 0.055  | —                               | 20.0Ω                           | —                               | —                               | —                        | —                                      | —                                      |
| 0.080  | —                               | 17.0Ω                           | —                               | —                               | 8.0Ω                     | —                                      | —                                      |
| 0.100  | 11.0Ω                           | —                               | —                               | —                               | —                        | —                                      | —                                      |
| 0.110  | —                               | 7.0Ω                            | —                               | —                               | —                        | —                                      | —                                      |
| 0.120  | 10.5Ω                           | 8.0Ω                            | —                               | —                               | —                        | —                                      | —                                      |
| 0.130  | —                               | —                               | 9.0Ω                            | 5.5Ω                            | —                        | —                                      | —                                      |
| 0.145  | 7.0Ω                            | 4.5Ω                            | —                               | —                               | —                        | —                                      | —                                      |
| 0.150  | —                               | —                               | —                               | —                               | —                        | —                                      | 8.0Ω                                   |
| 0.160  | —                               | —                               | —                               | —                               | —                        | —                                      | 6.0Ω                                   |
| 0.170  | —                               | —                               | —                               | —                               | —                        | 11.0Ω                                  | —                                      |
| 0.183  | —                               | 1.3Ω                            | —                               | —                               | —                        | —                                      | —                                      |
| 0.184  | —                               | 1.9Ω                            | —                               | 1.6Ω                            | —                        | —                                      | —                                      |
| 0.200  | —                               | —                               | —                               | —                               | —                        | 8.5Ω                                   | —                                      |
| 0.250  | —                               | —                               | —                               | —                               | —                        | 3.5Ω                                   | 3.0Ω                                   |
| 0.400  | —                               | —                               | —                               | —                               | —                        | 1.2Ω                                   | 1.2Ω                                   |

### Voltage Ratings for Telecommunications and Networking Devices

For circuit protection telecommunications devices there are two applicable voltage ratings. These are V<sub>MAX</sub> Operating and V<sub>MAX</sub> Interrupt. To help understand the nature of these two different voltage ratings, the following definitions are provided:

**V<sub>MAX</sub> Operating:** For telecommunications devices, this is the voltage used to obtain component recognition under UL1434. Most circuit protection devices are certified at 60V but can withstand higher V<sub>MAX</sub> Interrupt conditions. See Table T3 for its V<sub>MAX</sub> Operating.

**\*V<sub>MAX</sub> Interrupt:** Under specified conditions, this is the highest voltage that can be applied to the device at the maximum current. Devices may trip safely under higher power level cross conditions, as listed above, to assist equipment in meeting the appropriate industry conditions.

**Table T2 Thermal Derating for PolySwitch Telecommunications and Networking Devices [Hold Current (A) at Ambient Temperature (°C)]**

| Part Number                               | Maximum Ambient Temperature |       |       |       |       |       |       |       |       |
|---|-----------------------------|-------|-------|-------|-------|-------|-------|-------|-------|
|   | -40°C                       | -20°C | 0°C   | 20°C  | 40°C  | 50°C  | 60°C  | 70°C  | 85°C  |
| <b>Chip* — 250V<sub>AC</sub></b>          |                             |       |       |       |       |       |       |       |       |
| <b>TCF250</b>                             |                             |       |       |       |       |       |       |       |       |
| TCF250-100T                               | 0.155                       | 0.138 | 0.119 | 0.100 | 0.083 | 0.073 | 0.064 | 0.055 | 0.042 |
| TCF250-120T                               | 0.186                       | 0.165 | 0.143 | 0.120 | 0.099 | 0.088 | 0.077 | 0.066 | 0.050 |
| TCF250-145T                               | 0.225                       | 0.199 | 0.172 | 0.145 | 0.119 | 0.106 | 0.093 | 0.080 | 0.060 |
| TCF250-180†                               | 0.269                       | 0.240 | 0.211 | 0.180 | 0.153 | 0.138 | 0.123 | 0.109 | 0.087 |
| <b>Radial-led* — 250V<sub>AC</sub></b>    |                             |       |       |       |       |       |       |       |       |
| <b>TRF250</b>                             |                             |       |       |       |       |       |       |       |       |
| TRF250-055UT                              | 0.085                       | 0.076 | 0.065 | 0.055 | 0.045 | 0.041 | 0.035 | 0.030 | 0.023 |
| TRF250-080U                               | 0.124                       | 0.110 | 0.095 | 0.080 | 0.066 | 0.059 | 0.051 | 0.044 | 0.033 |
| TRF250-110U                               | 0.171                       | 0.151 | 0.131 | 0.110 | 0.091 | 0.081 | 0.071 | 0.061 | 0.046 |
| TRF250-120                                | 0.186                       | 0.165 | 0.143 | 0.120 | 0.099 | 0.088 | 0.077 | 0.066 | 0.050 |
| TRF250-145                                | 0.225                       | 0.199 | 0.172 | 0.145 | 0.119 | 0.106 | 0.093 | 0.080 | 0.060 |
| TRF250-183‡                               | 0.284                       | 0.251 | 0.217 | 0.183 | 0.149 | 0.133 | 0.117 | 0.101 | 0.075 |
| TRF250-184‡                               | 0.286                       | 0.252 | 0.218 | 0.184 | 0.150 | 0.134 | 0.118 | 0.102 | 0.075 |
| <b>Surface-mount* — 250V<sub>AC</sub></b> |                             |       |       |       |       |       |       |       |       |
| <b>TS250/TSL250/TSV250</b>                |                             |       |       |       |       |       |       |       |       |
| TSL250-080F                               | 0.124                       | 0.110 | 0.095 | 0.080 | 0.066 | 0.059 | 0.051 | 0.044 | 0.033 |
| TS250-130F                                | 0.208                       | 0.182 | 0.156 | 0.130 | 0.104 | 0.091 | 0.078 | 0.065 | 0.045 |
| TSV250-130F                               | 0.208                       | 0.182 | 0.156 | 0.130 | 0.104 | 0.091 | 0.078 | 0.065 | 0.045 |
| TSV250-184F                               | 0.286                       | 0.252 | 0.218 | 0.184 | 0.150 | 0.134 | 0.118 | 0.102 | 0.075 |
| <b>Radial-led† — 600V<sub>AC</sub></b>    |                             |       |       |       |       |       |       |       |       |
| <b>TRF600</b>                             |                             |       |       |       |       |       |       |       |       |
| TRF600-150                                | 0.239                       | 0.209 | 0.180 | 0.150 | 0.121 | 0.107 | 0.093 | 0.079 | 0.057 |
| TR600-150F-EX                             | 0.239                       | 0.209 | 0.180 | 0.150 | 0.121 | 0.107 | 0.093 | 0.079 | 0.057 |
| TR600-150F-EX-RA                          | 0.239                       | 0.209 | 0.180 | 0.150 | 0.121 | 0.107 | 0.093 | 0.079 | 0.057 |
| TRF600-160                                | 0.255                       | 0.223 | 0.192 | 0.160 | 0.129 | 0.114 | 0.099 | 0.084 | 0.061 |
| TRF600-250                                | 0.400                       | 0.350 | 0.300 | 0.250 | 0.198 | 0.170 | 0.140 | 0.117 | 0.083 |
| TRF600-400                                | 0.640                       | 0.560 | 0.480 | 0.400 | 0.320 | 0.270 | 0.230 | 0.190 | 0.130 |
| <b>Surface-mount† — 600V<sub>AC</sub></b> |                             |       |       |       |       |       |       |       |       |
| <b>TSM600/TSM600</b>                      |                             |       |       |       |       |       |       |       |       |
| TS600-170F                                | 0.264                       | 0.230 | 0.200 | 0.170 | 0.140 | 0.125 | 0.109 | 0.094 | 0.070 |
| TS600-200F-RA-B-0.5                       | 0.310                       | 0.275 | 0.238 | 0.200 | 0.165 | 0.147 | 0.128 | 0.110 | 0.083 |
| TS600-400F                                | 0.640                       | 0.560 | 0.480 | 0.400 | 0.320 | 0.270 | 0.230 | 0.190 | 0.130 |
| TSM600-250F                               | 0.400                       | 0.350 | 0.300 | 0.250 | 0.198 | 0.170 | 0.140 | 0.117 | 0.083 |
| TSM600-250F-RA                            | 0.400                       | 0.350 | 0.300 | 0.250 | 0.198 | 0.170 | 0.140 | 0.117 | 0.083 |
| TSM600-400F                               | 0.640                       | 0.560 | 0.480 | 0.400 | 0.320 | 0.270 | 0.230 | 0.190 | 0.130 |

\* 250V<sub>AC</sub> interrupt products may help equipment pass ITU K.20, K.21 and K.45 recommendations and Telcordia GR-1089 Port Type 2 and 4 requirements.

† 600V<sub>AC</sub> interrupt products may help equipment pass UL60950, TIA-968-A and GR1089 Port Type 1, 3 and 5 requirements.

‡ Product is not currently available in a resistance matched or sorted option.

**Figure T1 Thermal Derating [Hold Current (A) at Ambient Temperature (°C)]**

- A = TCF250-180
- B = All other TCF, TRF, TSM Series Devices

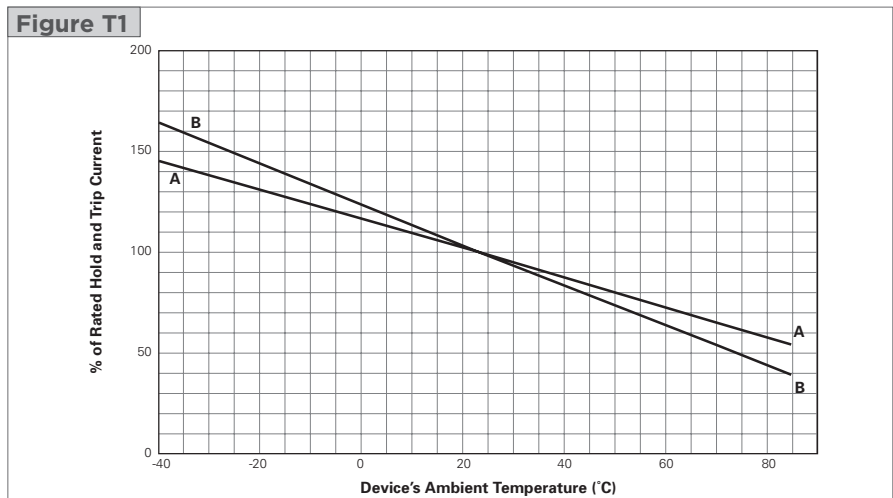

**Table T3 Electrical Characteristics for PolySwitch Telecommunications and Networking Devices**

| Part Number                               | I <sub>H</sub> (A) | I <sub>T</sub> (A) | V <sub>MAX</sub>             |                               | I <sub>MAX</sub> *† (A) | P <sub>D</sub> TYP (W) | Typical Time-to-trip |      | R <sub>MIN</sub> (Ω) | R <sub>MAX</sub> (Ω) | R <sub>1MAX</sub> (Ω) |
|---|--------------------|--------------------|------------------------------|-------------------------------|-------------------------|------------------------|----------------------|------|----------------------|----------------------|-----------------------|
|   |                    |                    | Operating (V <sub>DC</sub> ) | Interrupt (V <sub>RMS</sub> ) |                         |                        | (A)                  | (s)  |                      |                      |                       |
| <b>Chip* — 250V<sub>AC</sub></b>          |                    |                    |                              |                               |                         |                        |                      |      |                      |                      |                       |
| <b>TCF250</b>                             |                    |                    |                              |                               |                         |                        |                      |      |                      |                      |                       |
| TCF250-100T                               | 0.100              | 0.150              | 60                           | 250                           | 3.0                     | 0.6                    | 1.0                  | 0.2  | 14.0                 | 18.0                 | 24.0                  |
| TCF250-120T                               | 0.120              | 0.240              | 60                           | 250                           | 3.0                     | 1.0                    | 1.0                  | 0.6  | 6.3                  | 12.0                 | 18.0                  |
| TCF250-145T                               | 0.145              | 0.290              | 60                           | 250                           | 3.0                     | 1.0                    | 1.0                  | 1.5  | 5.0                  | 9.0                  | 14.0                  |
| TCF250-180†                               | 0.180              | 0.650              | 60                           | 250                           | 3.0                     | 0.9                    | 1.0                  | 15.5 | 1.0                  | 2.2                  | 4.0                   |
| <b>Radial-led* — 250V<sub>AC</sub></b>    |                    |                    |                              |                               |                         |                        |                      |      |                      |                      |                       |
| <b>TRF250</b>                             |                    |                    |                              |                               |                         |                        |                      |      |                      |                      |                       |
| TRF250-055UT                              | 0.055              | 0.170              | 60                           | 250                           | 3.0                     | 0.6                    | 0.28                 | 3.0  | 15.0                 | 25.0                 | 35.0                  |
| TRF250-080T                               | 0.080              | 0.160              | 60                           | 250                           | 3.0                     | 0.6                    | 0.35                 | 2.5  | 15.0                 | 22.0                 | 33.0                  |
| TRF250-080U                               | 0.080              | 0.160              | 60                           | 250                           | 3.0                     | 0.6                    | 0.35                 | 2.5  | 14.0                 | 20.0                 | 33.0                  |
| TRF250-110U                               | 0.110              | 0.220              | 60                           | 250                           | 3.0                     | 1.0                    | 1.00                 | 0.8  | 5.0                  | 9.0                  | 16.0                  |
| TRF250-120                                | 0.120              | 0.240              | 60                           | 250                           | 3.0                     | 1.0                    | 1.00                 | 1.5  | 4.0                  | 8.0                  | 16.0                  |
| TRF250-120T                               | 0.120              | 0.240              | 60                           | 250                           | 3.0                     | 1.0                    | 0.35                 | 0.7  | 7.0                  | 12.0                 | 16.0                  |
| TRF250-120T-RA                            | 0.120              | 0.240              | 60                           | 250                           | 3.0                     | 1.0                    | 1.00                 | 1.2  | 7.0                  | 9.0                  | 16.0                  |
| TRF250-120T-RC                            | 0.130              | 0.260              | 60                           | 250                           | 3.0                     | 1.0                    | 1.00                 | 1.5  | 5.4                  | 7.5                  | 14.0                  |
| TRF250-120T-RF                            | 0.120              | 0.240              | 60                           | 250                           | 3.0                     | 1.0                    | 1.00                 | 0.9  | 6.0                  | 10.5                 | 16.0                  |
| TRF250-120T-R1                            | 0.120              | 0.240              | 60                           | 250                           | 3.0                     | 1.0                    | 1.00                 | 1.0  | 6.0                  | 9.0                  | 16.0                  |
| TRF250-120T-R2                            | 0.120              | 0.240              | 60                           | 250                           | 3.0                     | 1.0                    | 1.00                 | 0.8  | 8.0                  | 10.5                 | 16.0                  |
| TRF250-120U                               | 0.120              | 0.240              | 60                           | 250                           | 3.0                     | 1.0                    | 1.00                 | 1.0  | 6.0                  | 10.0                 | 16.0                  |
| TRF250-120UT                              | 0.120              | 0.240              | 60                           | 250                           | 3.0                     | 1.0                    | 1.00                 | 0.7  | 7.0                  | 12.0                 | 16.0                  |
| TRF250-145                                | 0.145              | 0.290              | 60                           | 250                           | 3.0                     | 1.0                    | 1.00                 | 2.5  | 3.0                  | 6.0                  | 14.0                  |
| TRF250-145-RA                             | 0.145              | 0.290              | 60                           | 250                           | 3.0                     | 1.0                    | 1.00                 | 2.5  | 3.0                  | 5.5                  | 12.0                  |
| TRF250-145-RB                             | 0.145              | 0.290              | 60                           | 250                           | 3.0                     | 1.0                    | 1.00                 | 2.0  | 4.5                  | 6.0                  | 14.0                  |
| TRF250-145T                               | 0.145              | 0.290              | 60                           | 250                           | 3.0                     | 1.0                    | 1.00                 | 1.5  | 5.4                  | 7.5                  | 14.0                  |
| TRF250-145U                               | 0.145              | 0.290              | 60                           | 250                           | 3.0                     | 1.0                    | 1.00                 | 2.0  | 3.5                  | 6.5                  | 14.0                  |
| TRF250-183†                               | 0.183              | 0.685              | 100                          | 250                           | 10.0                    | 0.9                    | 3.00                 | 0.6  | 0.8                  | 2.2                  | 3.4                   |
| TRF250-184†                               | 0.184              | 1.000              | 100                          | 250                           | 10.0                    | 0.9                    | 3.00                 | 0.5  | 1.2                  | 2.4                  | 3.1                   |
| <b>Surface-mount* — 250V<sub>AC</sub></b> |                    |                    |                              |                               |                         |                        |                      |      |                      |                      |                       |
| <b>TS250/TSL250/TSV250</b>                |                    |                    |                              |                               |                         |                        |                      |      |                      |                      |                       |
| TSL250-080F                               | 0.080              | 0.240              | 80                           | 250                           | 3.0                     | 1.2                    | 1.0                  | 0.8  | 5.0                  | 11.0                 | 20.0**                |
| TS250-130F                                | 0.130              | 0.260              | 60                           | 250                           | 3.0                     | 1.1                    | 1.0                  | 0.9  | 6.5                  | 12.0                 | 20.0**                |
|   | —                  | —                  | 60                           | 600                           | 1.0                     | —                      | —                    | —    | —                    | —                    | —                     |
| TS250-130F-RA                             | 0.130              | 0.260              | 60                           | 250                           | 3.0                     | 1.1                    | 1.0                  | 1.4  | 6.5                  | 9.0                  | 15.0**                |
|   | —                  | —                  | 60                           | 600                           | 1.0                     | —                      | —                    | —    | —                    | —                    | —                     |
| TS250-130F-RB                             | 0.130              | 0.260              | 60                           | 250                           | 3.0                     | 1.1                    | 1.0                  | 0.7  | 9.0                  | 12.0                 | 20.0**                |
|   | —                  | —                  | 60                           | 600                           | 1.0                     | —                      | —                    | —    | —                    | —                    | —                     |
| TS250-130F-RC                             | 0.130              | 0.260              | 60                           | 250                           | 3.0                     | 1.1                    | 1.0                  | 1.1  | 7.0                  | 10.0                 | 17.0**                |
|   | —                  | —                  | 60                           | 600                           | 1.0                     | —                      | —                    | —    | —                    | —                    | —                     |
| TSV250-130F                               | 0.130              | 0.260              | 60                           | 250                           | 3.0                     | 1.5                    | 1.0                  | 2.0  | 4.0                  | 7.0                  | 12.0**                |
| TSV250-184F                               | 0.184              | 0.690              | 100                          | 250                           | 10.0                    | 0.9                    | 3.0                  | 0.5  | 1.2                  | 3.0                  | 4.0**                 |
| <b>Radial-led† — 600V<sub>AC</sub></b>    |                    |                    |                              |                               |                         |                        |                      |      |                      |                      |                       |
| <b>TRF600</b>                             |                    |                    |                              |                               |                         |                        |                      |      |                      |                      |                       |
| TRF600-150                                | 0.150              | 0.300              | 250                          | 600                           | 3.0                     | 1.4                    | 1.0                  | 1.4  | 6.0                  | 10.0                 | 17.0                  |
| TRF600-150-RB                             | 0.130              | 0.260              | 250                          | 600                           | 3.0                     | 1.0                    | 1.0                  | 1.0  | 9.0                  | 12.0                 | 22.0                  |
| TR600-150F-EX                             | 0.150              | 0.300              | 250                          | 600                           | 3.0                     | 1.4                    | 1.0                  | 5.0  | 6.0                  | 12.0                 | 22.0                  |
| TR600-150F-EX-RA-B-0.5                    | 0.150              | 0.300              | 250                          | 600                           | 3.0                     | 1.4                    | 1.0                  | 5.0  | 7.0                  | 10.0                 | 20.0                  |
| TRF600-160                                | 0.160              | 0.320              | 250                          | 600                           | 3.0                     | 1.7                    | 1.0                  | 7.5  | 4.0                  | 10.0                 | 18.0                  |
| TRF600-160-RA                             | 0.160              | 0.320              | 250                          | 600                           | 3.0                     | 1.7                    | 1.0                  | 9.5  | 4.0                  | 7.0                  | 16.0                  |
| TRF600-160-R1                             | 0.160              | 0.320              | 250                          | 600                           | 3.0                     | 1.7                    | 1.0                  | 9.0  | 4.0                  | 8.0                  | 17.0                  |
| TRF600-250                                | 0.250              | 0.850              | 250                          | 600                           | 3.0                     | 2.0                    | 3.0                  | 1.0  | 1.0                  | 4.3                  | 7.0                   |
| TRF600-400                                | 0.400              | 1.000              | 60                           | 600                           | 3.0                     | 2.4                    | 3.0                  | 4.0  | 0.95                 | 1.45                 | 1.90                  |

 \* 250V<sub>AC</sub> interrupt products may help equipment pass ITU K.20, K.21 and K.45 recommendations and Telcordia GR-1089 Port Type 2 and 4 requirements.

 † 600V<sub>AC</sub> interrupt products may help equipment pass UL60950, TIA-968-A and GR1089 Port Type 1, 3 and 5 requirements.

‡ Product is not currently available in a resistance matched or sorted option.

 \*\* R<sub>1MAX</sub> measured 1 hour post-trip or 24 hours post-reflow at 20°C.

**Table T3 Electrical Characteristics for PolySwitch Telecommunications and Networking Devices** Cont'd

| Part Number                               | $I_H$ (A) | $I_T$ (A) | $V_{MAX}$              |                         | $I_{MAX}^{*†}$ (A) | $P_D$ Typ (W) | Typical Time-to-trip |      | $R_{MIN}$ ( $\Omega$ ) | $R_{MAX}$ ( $\Omega$ ) | $R_{1MAX}$ ( $\Omega$ ) |
|---|-----------|-----------|------------------------|-------------------------|--------------------|---------------|----------------------|------|------------------------|------------------------|-------------------------|
|   |           |           | Operating ( $V_{DC}$ ) | Interrupt ( $V_{RMS}$ ) |                    |               | (A)                  | (s)  |                        |                        |                         |
| <b>Surface-mount† — 600V<sub>AC</sub></b> |           |           |                        |                         |                    |               |                      |      |                        |                        |                         |
| <b>TS600/TSM600</b>                       |           |           |                        |                         |                    |               |                      |      |                        |                        |                         |
| TS600-170F                                | 0.170     | 0.400     | 60                     | 600                     | 3.0                | 2.5           | 1.0                  | 10.0 | 4.0                    | 9.0                    | 18.0                    |
| TS600-200F-RA-B-0.5                       | 0.200     | 0.400     | 60                     | 600                     | 3.0                | 2.5           | 1.0                  | 12.0 | 4.0                    | 7.5                    | 13.5                    |
| TS600-400F                                | 0.400     | 1.000     | 60                     | 600                     | 3.0                | 2.0           | 3.0                  | 5.0  | 0.5                    | 1.5                    | 2.0                     |
| TSM600-250F                               | 0.250     | 0.860     | 250                    | 600                     | 3.0                | 2.0           | 3.0                  | 0.8  | 1.0                    | 3.5                    | 7.0                     |
| TSM600-250F-RA                            | 0.250     | 0.860     | 250                    | 600                     | 3.0                | 2.0           | 3.0                  | 1.0  | 1.0                    | 3.0                    | 5.0                     |
| TSM600-400F                               | 0.400     | 1.000     | 250                    | 600                     | 3.0                | 2.0           | 3.0                  | 5.0  | 0.5                    | 1.5                    | 2.0                     |

**Notes:**

- $I_H$  : Hold current: maximum current device will pass without interruption in 20°C still air.
- $I_T$  : Trip current: minimum current that will switch the device from low resistance to high resistance in 20°C still air.
- $V_{MAX}$  Operating : Maximum continuous voltage device can withstand without damage at rated current. This voltage is used for component recognition under UL1434.
- $V_{MAX}$  Interrupt : Maximum voltage that can be safely placed across a device in its tripped state. Devices may trip safely under higher level power cross conditions to assist equipment in meeting the appropriate ITU, UL60950 or GR1089 industry requirements.
- $I_{MAX}$  Interrupt : Maximum fault current device can withstand without damage at rated operating voltage. This current is used for component recognition under UL1434. Devices may trip safely under higher level power cross conditions to assist equipment in meeting the appropriate ITU, UL60950 or GR1089 industry requirements.
- $P_D$  : Power dissipated from device when in the tripped state in 20°C still air.
- $R_{MIN}$  : Minimum resistance of device as supplied at 20°C unless otherwise specified.
- $R_{MAX}$  : Maximum resistance of device as supplied at 20°C unless otherwise specified.
- $R_{1MAX}$  : Maximum resistance measured one hour post-trip or post-reflow at 20°C.

\* 250V<sub>AC</sub> interrupt products may help equipment pass ITU K.20, K.21 and K.45 recommendations and Telcordia GR-1089 Port Type 2 and 4 requirements.

† 600V<sub>AC</sub> interrupt products may help equipment pass UL60950, TIA-968-A and GR1089 Port Type 1, 3 and 5 requirements.

**Figures T2-T13 Dimension Figures for PolySwitch Telecommunications and Networking Devices**
**Figure T2**

**Figure T3**

**Figure T4**

**Figure T5**

**Figure T6**

**Figure T7**



**Figure T8**



**Figure T9**



**Figure T10**



**Figure T11**



**Figure T12**



**Figure T13**



**Table T4 Dimensions & Weights for PolySwitch Telecommunications and Networking Devices**

| Part Number                      | Dimensions in Millimeters (Inches) |                |               |                |               |                |                            |               |                            |                |                |                |     |     | Figure | Device Mass (g)<br>(Only for Reference) |
|----------------------------------|------------------------------------|----------------|---------------|----------------|---------------|----------------|----------------------------|---------------|----------------------------|----------------|----------------|----------------|-----|-----|--------|---|
|                                  | A                                  |                | B             |                | C             |                | D                          |               | E                          |                | F              |                | G   |     |        |   |
|                                  | Min                                | Max            | Min           | Max            | Min           | Max            | Min                        | Max           | Min                        | Max            | Min            | Max            | Min | Max |        |   |
| <b>TCF-250V*</b>                 |                                    |                |               |                |               |                |                            |               |                            |                |                |                |     |     |        |   |
| TCF250-100T                      | 4.6<br>(0.18)                      | 4.9<br>(0.19)  | 4.6<br>(0.18) | 4.9<br>(0.19)  | 2.0<br>(0.08) | 2.3<br>(0.09)  | —                          | —             | —                          | —              | —              | —              | —   | —   | T4     | 0.24                                    |
| TCF250-120T                      | 5.4<br>(0.21)                      | 5.6<br>(0.22)  | 5.4<br>(0.21) | 5.6<br>(0.22)  | 2.0<br>(0.08) | 2.3<br>(0.09)  | —                          | —             | —                          | —              | —              | —              | —   | —   | T4     | 0.28                                    |
| TCF250-145T                      | 5.4<br>(0.21)                      | 5.6<br>(0.22)  | 5.4<br>(0.21) | 5.6<br>(0.22)  | 2.0<br>(0.08) | 2.5<br>(0.10)  | —                          | —             | —                          | —              | —              | —              | —   | —   | T4     | 0.28                                    |
| TCF250-180                       | 6.9<br>(0.27)                      | 7.1<br>(0.28)  | 6.9<br>(0.27) | 7.1<br>(0.28)  | 1.3<br>(0.05) | 1.6<br>(0.06)  | —                          | —             | —                          | —              | —              | —              | —   | —   | T4     | 0.35                                    |
| <b>TRF250-250V*</b>              |                                    |                |               |                |               |                |                            |               |                            |                |                |                |     |     |        |   |
| TRF250-055UT                     | —                                  | 4.8<br>(0.19)  | —             | 9.3<br>(0.37)  | —             | 3.8<br>(0.15)  | 4.7<br>(0.19)              | —             | 5.0 <sup>‡</sup><br>(0.20) | —              | —              | —              | —   | —   | T2     | 0.13                                    |
| TRF250-080T                      | —                                  | 5.8<br>(0.23)  | —             | 9.9<br>(0.39)  | —             | 4.6<br>(0.18)  | 4.7<br>(0.19)              | —             | 5.0 <sup>‡</sup><br>(0.20) | —              | —              | —              | —   | —   | T2     | 0.28                                    |
| TRF250-080U                      | —                                  | 4.8<br>(0.19)  | —             | 9.3<br>(0.37)  | —             | 3.8<br>(0.15)  | 4.7<br>(0.19)              | —             | 5.0 <sup>‡</sup><br>(0.20) | —              | —              | —              | —   | —   | T11    | 0.13                                    |
| TRF250-110U                      | —                                  | 5.3<br>(0.21)  | —             | 9.4<br>(0.37)  | —             | 3.8<br>(0.15)  | 4.7<br>(0.19)              | —             | 5.0 <sup>‡</sup><br>(0.20) | —              | —              | —              | —   | —   | T11    | 0.13                                    |
| TRF250-120                       | —                                  | 6.5<br>(0.26)  | —             | 11.0<br>(0.43) | —             | 4.6<br>(0.18)  | 4.7<br>(0.19)              | —             | 5.0 <sup>‡</sup><br>(0.20) | —              | —              | —              | —   | —   | T3     | 0.38                                    |
| TRF250-120U                      | —                                  | 6.0<br>(0.24)  | —             | 10.0<br>(0.39) | —             | 3.8<br>(0.15)  | 4.7<br>(0.19)              | —             | 5.0 <sup>‡</sup><br>(0.20) | —              | —              | —              | —   | —   | T10    | 0.19                                    |
| TRF250-145                       | —                                  | 6.5<br>(0.26)  | —             | 11.0<br>(0.43) | —             | 4.6<br>(0.18)  | 4.7<br>(0.19)              | —             | 5.0 <sup>‡</sup><br>(0.20) | —              | —              | —              | —   | —   | T3     | 0.38                                    |
| TRF250-145U                      | —                                  | 6.0<br>(0.24)  | —             | 10.0<br>(0.39) | —             | 3.8<br>(0.15)  | 4.7<br>(0.19)              | —             | 5.0 <sup>‡</sup><br>(0.20) | —              | —              | —              | —   | —   | T10    | 0.19                                    |
| TRF250-183                       | —                                  | 7.5<br>(0.29)  | —             | 10.5<br>(0.41) | —             | 4.1<br>(0.16)  | 4.7<br>(0.19)              | —             | 5.0 <sup>‡</sup><br>(0.20) | —              | —              | —              | —   | —   | T2     | 0.30                                    |
| TRF250-184                       | —                                  | 7.7<br>(0.30)  | —             | 10.5<br>(0.41) | —             | 4.6<br>(0.18)  | 4.7<br>(0.19)              | —             | 5.0 <sup>‡</sup><br>(0.20) | —              | —              | —              | —   | —   | T12    | 0.32                                    |
| <b>TS250/TSL250/TSV250-250V*</b> |                                    |                |               |                |               |                |                            |               |                            |                |                |                |     |     |        |   |
| TSL250-080F                      | 6.7<br>(0.27)                      | 7.9<br>(0.31)  | 2.7<br>(0.11) | 3.7<br>(0.15)  | 4.8<br>(0.19) | 5.3<br>(0.21)  | 0.2<br>(0.01)              | 0.4<br>(0.02) | 2.5<br>(0.10)              | 3.1<br>(0.12)  | —              | —              | —   | —   | T7     | 2.80                                    |
| TS250-130F                       | 8.5<br>(0.34)                      | 9.4<br>(0.37)  | —             | 3.4<br>(0.14)  | —             | 7.4<br>(0.29)  | 0.3 <sup>‡</sup><br>(0.01) | —             | 3.8 <sup>‡</sup><br>(0.15) | —              | —              | —              | —   | —   | T5     | 3.60                                    |
| TSV250-130F                      | —                                  | 6.10<br>(0.24) | —             | 6.90<br>(0.27) | —             | 3.20<br>(0.13) | 0.56<br>(0.02)             | —             | —                          | 1.90<br>(0.08) | 1.60<br>(0.07) | 2.30<br>(0.09) | —   | —   | T6     | 2.80                                    |
| TSV250-184F                      | —                                  | 6.10<br>(0.24) | —             | 6.90<br>(0.27) | —             | 3.20<br>(0.13) | 0.56<br>(0.02)             | —             | —                          | 1.90<br>(0.08) | 1.60<br>(0.07) | 2.30<br>(0.09) | —   | —   | T6     | 2.80                                    |
| <b>TRF600-600V<sup>†</sup></b>   |                                    |                |               |                |               |                |                            |               |                            |                |                |                |     |     |        |   |
| TRF600-150                       | —                                  | 9.0<br>(0.35)  | —             | 12.5<br>(0.49) | —             | 4.6<br>(0.18)  | 4.7<br>(0.19)              | —             | 5.0<br>(0.20)              | —              | —              | 9.0<br>(0.35)  | —   | —   | T3     | 0.37                                    |
| TR600-150F-EX                    | —                                  | 13.5<br>(0.53) | —             | 12.6<br>(0.50) | —             | 6.0<br>(0.18)  | 4.7<br>(0.19)              | —             | 5.0<br>(0.20)              | —              | —              | —              | —   | —   | T3     | 0.80                                    |
| TR600-150F-EX-RA-B-0.5           | —                                  | 13.5<br>(0.53) | —             | 12.6<br>(0.50) | —             | 6.0<br>(0.18)  | 4.7<br>(0.19)              | —             | 5.0<br>(0.20)              | —              | —              | —              | —   | —   | T3     | 0.80                                    |
| TRF600-160                       | —                                  | 16.0<br>(0.63) | —             | 12.6<br>(0.50) | —             | 6.0<br>(0.24)  | 4.7<br>(0.19)              | —             | 5.0 <sup>‡</sup><br>(0.20) | —              | —              | 10.0<br>(0.39) | —   | —   | T13    | 0.90                                    |
| TRF600-250                       | —                                  | 15.0<br>(0.59) | —             | 14.5<br>(0.57) | —             | 4.6<br>(0.18)  | 4.7<br>(0.19)              | —             | 5.0 <sup>‡</sup><br>(0.20) | —              | —              | 10.0<br>(0.39) | —   | —   | T3     | 0.87                                    |
| TRF600-400                       | —                                  | 14.8<br>(0.58) | —             | 13.1<br>(0.52) | —             | 4.6<br>(0.18)  | 4.7<br>(0.19)              | —             | 5.0 <sup>‡</sup><br>(0.20) | —              | —              | —              | —   | —   | T13    | 0.85                                    |

\* 250V<sub>AC</sub> interrupt products may help equipment pass ITU K.20, K.21 and K.45 recommendations and Telcordia GR-1089 Port Type 2 and 4 requirements.

† 600V<sub>AC</sub> interrupt products may help equipment pass UL60950, TIA-968-A and GR1089 Port Type 1, 3 and 5 requirements.

‡ Indicates dimension is typical, not minimum.

**Table T4 Dimensions & Weights for PolySwitch Telecommunications and Networking Devices** Cont'd

| Part Number               | Dimensions in Millimeters (Inches) |                 |                 |                 |                 |                 |                |                |                |                |                |               |               |               | Figure | Device Mass (g)<br>(Only for Reference) |
|---------------------------|------------------------------------|-----------------|-----------------|-----------------|-----------------|-----------------|----------------|----------------|----------------|----------------|----------------|---------------|---------------|---------------|--------|---|
|                           | A                                  |                 | B               |                 | C               |                 | D              |                | E              |                | F              |               | G             |               |        |   |
|                           | Min                                | Max             | Min             | Max             | Min             | Max             | Min            | Max            | Min            | Max            | Min            | Max           | Min           | Max           |        |   |
| <b>TS600/TSM600-600V†</b> |                                    |                 |                 |                 |                 |                 |                |                |                |                |                |               |               |               |        |   |
| TS600-170F                | 18.3<br>(0.72)                     | 19.4<br>(0.77)  | 11.6<br>(0.46)  | 12.3<br>(0.49)  | 7.2<br>(0.29)   | 8.3<br>(0.33)   | 1.7<br>(0.07)  | 2.4<br>(0.10)  | 9.9<br>(0.39)  | 10.4<br>(0.41) | 1.5<br>(0.06)  | 2.3<br>(0.09) | —             | —             | T8     | 23.6                                    |
| TS600-200F-RA             | 18.3<br>(0.72)                     | 19.4<br>(0.77)  | 11.6<br>(0.46)  | 12.3<br>(0.49)  | 7.2<br>(0.29)   | 8.3<br>(0.33)   | 1.7<br>(0.07)  | 2.4<br>(0.10)  | 9.9<br>(0.39)  | 10.4<br>(0.41) | 1.5<br>(0.06)  | 2.3<br>(0.09) | —             | —             | T8     | 23.6                                    |
| TS600-400F                | 18.3<br>(0.72)                     | 19.4<br>(0.77)  | 11.6<br>(0.46)  | 12.3<br>(0.49)  | 7.2<br>(0.29)   | 8.3<br>(0.33)   | 1.7<br>(0.07)  | 2.4<br>(0.10)  | 9.9<br>(0.39)  | 10.4<br>(0.41) | 1.5<br>(0.06)  | 2.3<br>(0.09) | —             | —             | T8     | 19.8                                    |
| TSM600-250F               | 17.0<br>(0.67)                     | 17.60<br>(0.69) | 11.20<br>(0.44) | 11.70<br>(0.46) | 10.40<br>(0.41) | 11.20<br>(0.44) | 4.80<br>(0.19) | 5.20<br>(0.20) | 2.50<br>(0.10) | 2.80<br>(0.11) | 0.60<br>(0.02) | 1.0<br>(0.04) | 2.2<br>(0.09) | 3.1<br>(0.12) | T9     | 31.2                                    |
| TSM600-250F-RA            | 17.0<br>(0.67)                     | 17.60<br>(0.69) | 11.20<br>(0.44) | 11.70<br>(0.46) | 10.40<br>(0.41) | 11.20<br>(0.44) | 4.80<br>(0.19) | 5.20<br>(0.20) | 2.50<br>(0.10) | 2.80<br>(0.11) | 0.60<br>(0.02) | 1.0<br>(0.04) | 2.2<br>(0.09) | 3.1<br>(0.12) | T9     | 31.2                                    |
| TSM600-400F               | 17.0<br>(0.67)                     | 17.60<br>(0.69) | 11.20<br>(0.44) | 11.70<br>(0.46) | 10.40<br>(0.41) | 11.20<br>(0.44) | 4.80<br>(0.19) | 5.20<br>(0.20) | 2.50<br>(0.10) | 2.80<br>(0.11) | 0.60<br>(0.02) | 1.0<br>(0.04) | 2.2<br>(0.09) | 3.1<br>(0.12) | T9     | 31.2                                    |

 † 600V<sub>AC</sub> interrupt products may help equipment pass UL60950, TIA-968-A and GR1089 Port Type 1, 3 and 5 requirements.

**TCF250**

- A = TCF250-180
- B = TCF250-145T
- C = TCF250-120T
- D = TCF250-100T

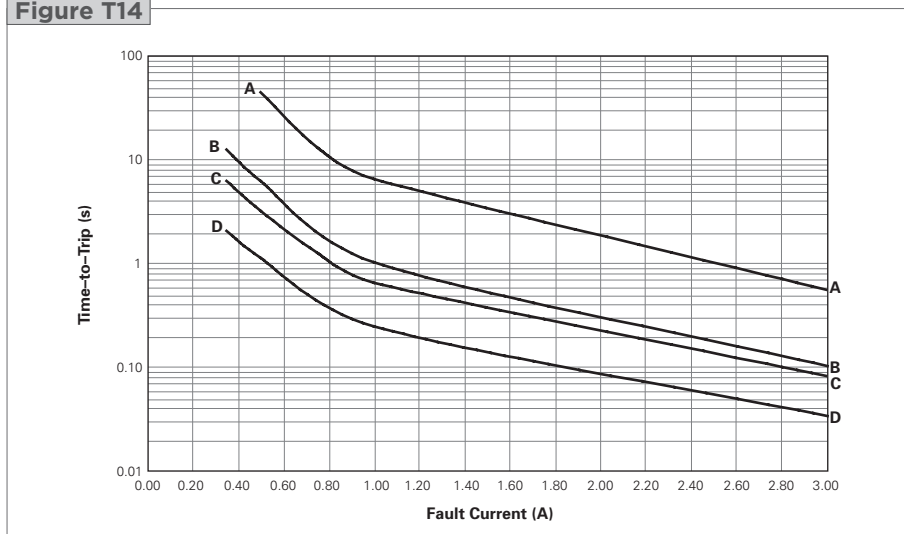
**Figure T14**

**TRF250**

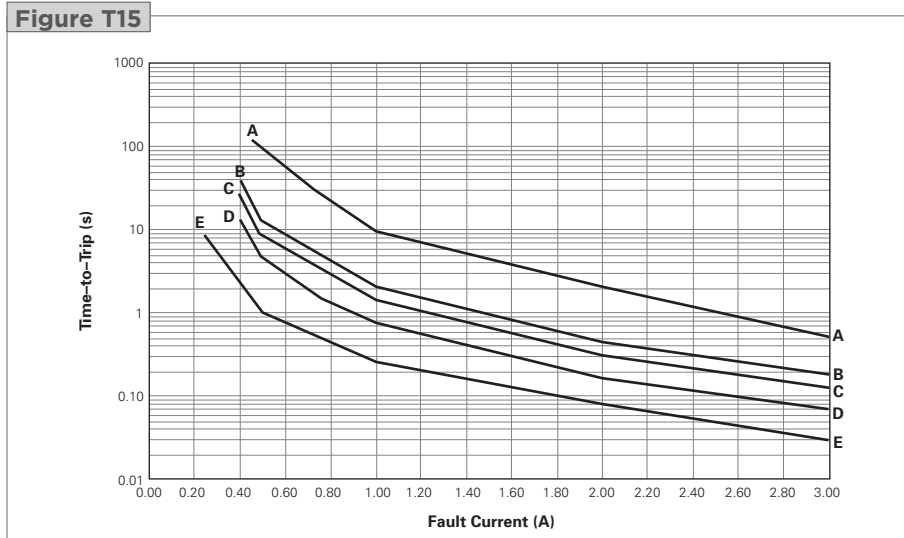
- A = TRF250-180/183/184
- B = TRF250-145/145U
- C = TRF250-120/120U
- D = TRF250-110U/120UT/120T
- E = TRF250-080T/080U/080US

**Figure T15**

**TS250/TSV250/TSL250**

- A = TSV250-184F
- B = TSV250-130F
- C = TS250-130F
- D = TSL250-080F

**Figure T16**



**TRF600/TS600/TSM600**

- A = TRF600-400/TS600-400/  
TSM600-400F
- B = TRF600-250/TSM600-250F/  
TS600-170F/200F
- C = TRF600-160
- D = TR600-150F-EX
- E = TRF600-150

**Figure T17**



**Table T5 Physical Characteristics and Environmental Specifications for PolySwitch Telecommunications and Networking Devices**

Operating temperature range for all listed products is -40°C to 85°C, except for TRF250-080T and TRF250-184 (0°C to 85°C)

**TCF250\***

**Physical Characteristics**

Terminal Material      Nickel-plated Copper Foil

**Environmental Specifications**

| Test               | Conditions                       |
|--------------------|----------------------------------|
| Passive Aging      | 60°C, 1000 hrs<br>85°C, 1000 hrs |
| Humidity Aging     | 85°C, 85% RH, 1000 hrs           |
| Thermal Shock      | 125°C, -55°C (10 Times)          |
| Solvent Resistance | MIL-STD-202, Method 215F         |

**Note:** Storage conditions: 40°C (max), 70% RH (max), devices should remain in original sealed bag prior to use. Devices may not meet specified values if these storage conditions are exceeded.

**Table T5 Physical Characteristics and Environmental Specifications for PolySwitch Telecommunications and Networking Devices**

Cont'd

**Operating temperature range for all listed products is -40°C to 85°C, except for TRF250-080T and TRF250-184 (0°C to 85°C)**
**TRF250\***
**Physical Characteristics**

|                           |  |
|---------------------------|--|
| Lead Material             | Tin-plated Copper, 22AWG   |
| Insulating Material       | Cured Epoxy Polymer  |
| Flammability              | Per IEC 695-2-2 Needle Flame Test for 20 s   |
| Soldering Characteristics | ANSI/J-STD-002, Category 3   |
| Solder Heat Withstand     | IEC-STD 68-2-20, Test Tb, Section 5 Method 1A, Condition B: Can Withstand 10s at 260°C±5°C |

**Note:** Devices are not intended to be placed through a reflow process.

**Environmental Specifications**

| Test               | Conditions               |
|--------------------|--------------------------|
| Passive Aging      | 60°C, 1000 hrs           |
|                    | 85°C, 1000 hrs           |
| Humidity Aging     | 85°C, 85% RH, 1000 hrs   |
| Thermal Shock      | 125°C, -55°C (10 Times)  |
| Solvent Resistance | MIL-STD-202, Method 215F |

**Note:** Storage conditions: 40°C (max), 70% RH (max), devices should remain in original sealed bag prior to use. Devices may not meet specified values if these storage conditions are exceeded.

**TS250/TSV250/TSL250\***
**Physical Characteristics**

|                           |  |
|---------------------------|--|
| Terminal Material         | Tin-plated Brass, Nickel Under-plating |
| Soldering Characteristics | EIC 60008-2-58                         |

**Environmental Specifications**

| Test               | Conditions               |
|--------------------|--------------------------|
| Passive Aging      | 60°C, 1000 hrs           |
|                    | 85°C, 1000 hrs           |
| Humidity Aging     | 85°C, 85% RH, 500 hrs    |
| Thermal Shock      | 125°C, -55°C (10 Times)  |
| Solvent Resistance | MIL-STD-202, Method 215F |

**Note:** Storage conditions: 40°C (max), 70% RH (max), devices should remain in original sealed bag prior to use. Devices may not meet specified values if these storage conditions are exceeded.

**TRF600†**
**Physical Characteristics**

|                           |   |
|---------------------------|---|
| Lead Material             | Tin-plated Copper, 22AWG  |
| Insulating Material       | Cured Epoxy Polymer <sup>‡</sup>  |
| Flammability              | Per IEC 695-2-2 Needle Flame Test for 20s   |
| Soldering Characteristics | ANSI/J-STD-002, Category 3  |
| Solder Heat Withstand     | IEC-STD 68-2-20, Test Tb, Section 5 Method 1A, Condition B: Can Withstand 10 s at 260°C±5°C |

**Note:** Devices are not intended to be placed through a reflow process.

**Environmental Specifications**

| Test               | Conditions                          |
|--------------------|-------------------------------------|
| Passive Aging      | 60°C, 1000 hrs                      |
|                    | 85°C, 1000 hrs                      |
| Humidity Aging     | 85°C, 85% RH, 1000 hrs <sup>‡</sup> |
| Thermal Shock      | 125°C, -55°C (10 Times)             |
| Solvent Resistance | MIL-STD-202, Method 215F            |

**Note:** Storage conditions: 40°C (max), 70% RH (max) devices should remain in original sealed bag prior to use. Devices may not meet specified values if these storage conditions are exceeded.

 \* 250V<sub>AC</sub> interrupt products may help equipment pass ITU K.20, K.21 and K.45 recommendations and Telcordia GR-1089 Port Type 2 and 4 requirements.

 † 600V<sub>AC</sub> interrupt products may help equipment pass UL60950, TIA-968-A and GR1089 Port Type 1, 3 and 5 requirements.

‡ Excluding TRF600-150 and TRF600-400, which have a coating that is not rated for dielectric withstand and can withstand 500h at 85°C/85% RH or 1000h at 60°C/90% RH.

**Table T5 Physical Characteristics and Environmental Specifications for PolySwitch Telecommunications and Networking Devices**

Cont'd

Operating temperature range for all listed products is -40°C to 85°C, except for TRF250-080T and TRF250-184 (0°C to 85°C)

**TS600<sup>†</sup>**

**Physical Characteristics**

|                           |  |
|---------------------------|--|
| Terminal Material         | Tin-plated Brass                               |
| Insulating Material       | Nylon Resin (UL94V-0), 1000V Dielectric Rating |
| Flammability              | IEC 695-2-2 Needle Flame Test for 20 s         |
| Soldering Characteristics | ANSI/J-STD-002, Category 3                     |
| Solder Heat Withstand     | IEC-STD 68-2-20, Test Tb, Section 5 Method 1A  |

**Environmental Specifications**

| Test               | Conditions               |
|--------------------|--------------------------|
| Passive Aging      | 60°C, 1000 hrs           |
|                    | 85°C, 1000 hrs           |
| Humidity Aging     | 85°C, 85% RH, 1000 hrs   |
| Thermal Shock      | 125°C, -55°C (10 Times)  |
| Solvent Resistance | MIL-STD-202, Method 215F |

**Note:** Storage conditions: 40°C (max), 70% RH (max), devices should remain in original sealed bag prior to use. Devices may not meet specified values if these storage conditions are exceeded.

**TSM600<sup>†</sup>**

**Physical Characteristics**

|                           |  |
|---------------------------|--|
| Terminal Material         | Tin-plated Brass                               |
| Insulating Material       | Nylon Resin (UL94V-0), 1000V Dielectric Rating |
| Flammability              | IEC 695-2-2 Needle Flame Test for 20 s         |
| Soldering Characteristics | EIC60068-2-58, Method 7                        |
| Solder Heat Withstand     | IEC-STD 68-2-20, Test Tb, Section 5 Method 1A  |

**Environmental Specifications**

| Test               | Conditions                        |
|--------------------|-----------------------------------|
| Passive Aging      | 60°C, 1000 hrs                    |
|                    | 85°C, 1000 hrs                    |
| Humidity Aging     | 85°C, 85% RH, 1000 hrs            |
| Storage Humidity   | Per IPC/JEDEC J-STD-020A Level 2a |
| Thermal Shock      | 125°C, -55°C (10 Times)           |
| Solvent Resistance | MIL-STD-202, Method 215J          |

**Note:** Storage conditions: 40°C (max), 70% RH (max) devices should remain in original sealed bag prior to use. Devices may not meet specified values if these storage conditions are exceeded.

<sup>†</sup> 600V<sub>AC</sub> interrupt products may help equipment pass UL60950, TIA-968-A and GR1089 Port Type 1, 3 and 5 requirements.

**Table T6 Packaging and Marking Information for PolySwitch Telecommunications and Networking Devices**

| Part Number                               | Bag Quantity | Tape and Reel Quantity | Standard Package Quantity | Part Marking | Agency Recognition |
|---|--------------|------------------------|---------------------------|--------------|--------------------|
| <b>Chip* — 250V<sub>AC</sub></b>          |              |                        |                           |              |                    |
| <b>TCF250</b>                             |              |                        |                           |              |                    |
| TCF250-100T                               | 2,500        | —                      | 10,000                    | —            | —                  |
| TCF250-120T                               | 2,500        | —                      | 10,000                    | —            | —                  |
| TCF250-145T                               | 2,500        | —                      | 10,000                    | —            | —                  |
| TCF250-180                                | 2,500        | —                      | 10,000                    | —            | UL                 |
| <b>Radial-leaded* — 250V<sub>AC</sub></b> |              |                        |                           |              |                    |
| <b>TRF250</b>                             |              |                        |                           |              |                    |
| TRF250-055UT                              | 500          | —                      | 10,000                    | —            | —                  |
| TRF250-080U                               | 500          | —                      | 10,000                    | —            | UL, CSA, TÜV       |
| TRF250-080U-2                             | —            | 1,500                  | 7,500                     | —            | UL, CSA, TÜV       |
| TRF250-080T                               | 500          | —                      | 10,000                    | 08F          | UL, CSA, TÜV       |
| TRF250-110U                               | 500          | —                      | 10,000                    | —            | UL, CSA, TÜV       |
| TRF250-120                                | 500          | —                      | 10,000                    | 20F          | UL, CSA, TÜV       |
| TRF250-120-2                              | —            | 1,500                  | 7,500                     | 20F          | UL, CSA, TÜV       |
| TRF250-120T                               | 500          | —                      | 10,000                    | 20F          | UL, CSA, TÜV       |
| TRF250-120T-2                             | —            | 1,500                  | 7,500                     | 20F          | UL, CSA, TÜV       |
| TRF250-120U                               | 500          | —                      | 10,000                    | 20F          | UL, CSA, TÜV       |
| TRF250-120U-2                             | —            | 1,500                  | 7,500                     | 20F          | UL, CSA, TÜV       |
| TRF250-120UT                              | 500          | —                      | 10,000                    | 20F          | UL, CSA, TÜV       |
| TRF250-145                                | 500          | —                      | 10,000                    | 45F          | UL, CSA, TÜV       |
| TRF250-145-2                              | —            | 1,500                  | 7,500                     | 45F          | UL, CSA, TÜV       |
| TRF250-145-RA                             | 500          | —                      | 10,000                    | 45F          | UL, CSA, TÜV       |
| TRF250-145U                               | 500          | —                      | 10,000                    | 45F          | UL, CSA, TÜV       |
| TRF250-145U-2                             | —            | 1,500                  | 7,500                     | 45F          | UL, CSA, TÜV       |
| TRF250-183                                | 500          | —                      | 10,000                    | 83F          | UL, CSA, TÜV       |
| TRF250-183-2                              | —            | 1,500                  | 7,500                     | 83F          | UL, CSA, TÜV       |
| TRF250-184                                | 500          | —                      | 10,000                    | 84F          | UL, CSA, TÜV       |
| <b>Surface-mount* — 250V<sub>AC</sub></b> |              |                        |                           |              |                    |
| <b>TS250/TSL250/TSV250</b>                |              |                        |                           |              |                    |
| TSL250-080F-2                             | —            | 1,500                  | 7,500                     | T08          | UL, CSA, TÜV       |
| TS250-130F-2                              | —            | 1,500                  | 7,500                     | T13          | UL, CSA, TÜV       |
| TSV250-130F-2                             | —            | 1,200                  | 6,000                     | T13V         | UL, CSA, TÜV       |
| TSV250-184F                               | 2500         | —                      | 10,000                    | T18V         | UL                 |
| <b>Radial-leaded† — 600V<sub>AC</sub></b> |              |                        |                           |              |                    |
| <b>TRF600</b>                             |              |                        |                           |              |                    |
| TRF600-150                                | 500          | —                      | 10,000                    | 150F         | UL, CSA, TÜV       |
| TRF600-150-2                              | —            | 1,500                  | 7,500                     | 150F         | UL, CSA, TÜV       |
| TR600-150F-EX                             | 500          | —                      | 10,000                    | 150F         | UL, CSA            |
| TR600-150F-EX-2                           | —            | 600                    | 3,000                     | 150F         | UL, CSA            |
| TR600-150F-EX-RA-B-0.5                    | 500          | —                      | 10,000                    | 150F         | UL, CSA            |
| TRF600-160                                | 500          | —                      | 10,000                    | 160F         | UL, CSA, TÜV       |
| TRF600-160-2                              | —            | 600                    | 3,000                     | 160F         | UL, CSA, TÜV       |
| TRF600-250                                | 500          | —                      | 10,000                    | 250F         | UL, CSA, TÜV       |
| TRF600-400                                | 500          | —                      | 10,000                    | 400F         | UL, CSA            |
| <b>Surface-mount† — 600V<sub>AC</sub></b> |              |                        |                           |              |                    |
| <b>TSM600/TSM600</b>                      |              |                        |                           |              |                    |
| TSM600-170F-2                             | —            | 300                    | 900                       | T20          | UL, CSA            |
| TSM600-200F-RA-2                          | —            | 300                    | 900                       | T20          | UL, CSA            |
| TSM600-400F-2                             | —            | 300                    | 900                       | T40          | UL, CSA            |
| TSM600-250F-2                             | —            | 200                    | 1,000                     | TSM600       | UL, CSA            |
| TSM600-250F-RA-2                          | —            | 200                    | 1,000                     | TSM600       | UL, CSA            |
| TSM600-400F-2                             | —            | 200                    | 1,000                     | TSM600       | UL                 |

 \* 250V<sub>AC</sub> interrupt products are designed to help equipment pass ITU K.20, K.21 and K.45 recommendations and Telcordia GR-1089 Port Type 2 and 4 requirements.

 † 600V<sub>AC</sub> interrupt products are designed to help equipment pass UL60950, TIA-968-A and GR1089 Port Type 1, 3 and 5 requirements.

## Agency Recognition for PolySwitch Telecommunications and Networking Devices

|     |                |   |
|-----|----------------|---|
| UL  | File # E74889  |   |
| CSA | File # 78165C  |   |
| TÜV | Per IEC60730-1 | Certificate # for individual products available upon request. |

**Table T7 Recommended Pad Layouts for Surface-mount PolySwitch Telecommunications and Networking Devices in Millimeters (Inches) Nominal**

| Device       | A                | B                | C               | D               | E               | F               | G               | Figure |
|--------------|------------------|------------------|-----------------|-----------------|-----------------|-----------------|-----------------|--------|
| TS250 (All)  | 4.60<br>(0.180)  | 1.80<br>(0.070)  | 6.10<br>(0.240) | —               | —               | —               | —               | T18    |
| TSV250 (All) | 2.29<br>(0.090)  | 2.41<br>(0.095)  | 6.35<br>(0.250) | 3.43<br>(0.135) | —               | —               | —               | T19    |
| TSL250 (All) | 3.60<br>(0.140)  | 1.80<br>(0.070)  | 5.50<br>(0.220) | —               | —               | —               | —               | T18    |
| TS600 (All)  | 10.42<br>(0.410) | 3.30<br>(0.130)  | 3.35<br>(0.132) | —               | —               | —               | —               | T18    |
| TSM600 (All) | 5.20<br>(0.205)  | 17.80<br>(0.701) | 5.54<br>(0.218) | 6.75<br>(0.266) | 2.08<br>(0.082) | 3.12<br>(0.123) | 8.39<br>(0.331) | T20    |

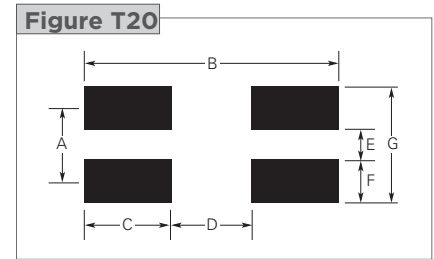
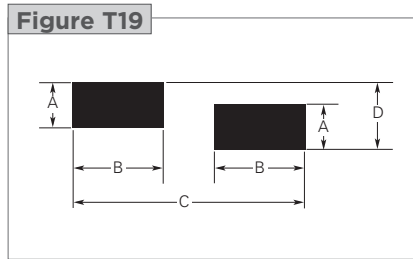

## Solder Reflow and Rework Recommendations for PolySwitch Telecommunications Surface-Mount Devices

| Profile Feature   | Pb-Free Assembly |
|---|------------------|
| <b>Average ramp up rate (<math>T_{sMAX}</math> to <math>T_p</math>)</b> | 3°C/s max        |
| <b>Preheat</b>  |                  |
| • Temperature min ( $T_{sMIN}$ )  | 150°C            |
| • Temperature max ( $T_{sMAX}$ )  | 200°C            |
| • Time ( $t_{sMIN}$ to $t_{sMAX}$ )                                     | 60-180 s         |
| <b>Time maintained above:</b>   |                  |
| • Temperature ( $T_L$ )   | 217°C            |
| • Time ( $t_L$ )  | 60-150 s         |
| <b>Peak/Classification temperature (<math>T_p</math>)</b>               | 260°C            |
| <b>Time within 5°C of actual peak temperature</b>                       |                  |
| Time ( $t_p$ )  | 20-40 s          |
| <b>Ramp down rate</b>   | 6°C/s max        |
| <b>Time 25°C to peak temperature</b>                                    | 8min max         |

**Note:** All temperatures refer to topside of the package, measured on the package body surface.

### Solder Reflow

- Recommended reflow method: IR, vapor phase oven, hot air oven.
- Surface-mount devices are not intended to be wave soldered to the bottom side of the board.
- Recommended maximum paste thickness of 0.25mm (0.010in).
- Devices can be cleaned using standard industry methods and solvents.

### Rework

- If a device is removed from the board, it should be discarded and replaced with a new device.

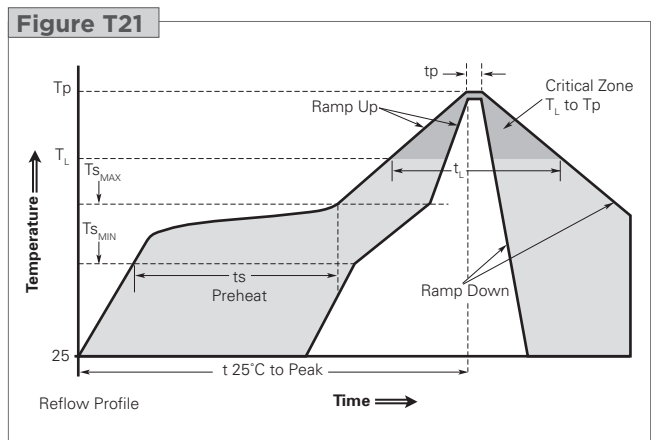



## Wave Soldering and Rework Recommendations for PolySwitch Telecommunications Radial-Leaded Devices

### Recommended Wave Soldering

- Soldering temperature profile  
Temperature characteristic at component terminal with dual wave soldering

### Rework

- If a device is removed from the board, it should be discarded and replaced with a new device

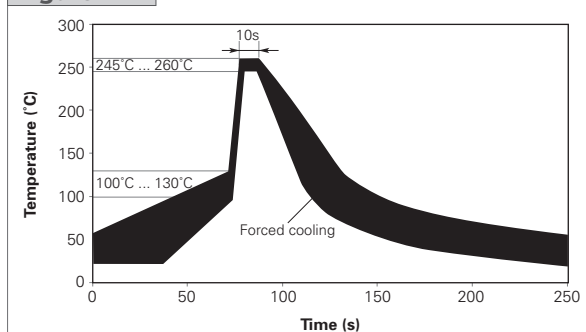
**Figure T22**

**Table T8 TRF250/TRF600 Tape and Reel Specifications for PolySwitch Telecommunications and Networking Device**

TRF250/TRF600 devices are available in tape and reel packaging per EIA 468-B standard. See Figures T23 and T24 for details.

| Dimension Description                  | EIA Mark        | IEC Mark       | Dimension (mm) | Tolerance  |
|--|-----------------|----------------|----------------|------------|
| Carrier Tape Width                     | W               | W              | 18             | -0.5/+1.0  |
| Hold Down Tape Width                   | W <sub>4</sub>  | W <sub>0</sub> | 5              | Min        |
| Top Distance between Tape Edges        | W <sub>6</sub>  | W <sub>2</sub> | 3              | Max        |
| Sprocket Hole Position                 | W <sub>5</sub>  | W <sub>1</sub> | 9              | -0.5/+0.75 |
| Sprocket Hole Diameter                 | D <sub>0</sub>  | D <sub>0</sub> | 4              | ±0.2       |
| Abcissa to Plane (Straight Lead)       | H               | H              | 18.5           | ±3.0       |
| Abcissa to Plane (Kinked Lead)*        | H <sub>0</sub>  | H <sub>0</sub> | 16             | -0.5/+0.6  |
| Abcissa to Top                         | H <sub>1</sub>  | H <sub>1</sub> | 32.2           | Max        |
| Overall Width with Lead Protrusion     | —               | C <sub>1</sub> | 43.2           | Max        |
| Overall Width without Lead Protrusion  | —               | C <sub>2</sub> | 42.5           | Max        |
| Lead Protrusion                        | L <sub>1</sub>  | I <sub>1</sub> | 1.0            | Max        |
| Protrusion of Cut-out                  | L               | L              | 11             | Max        |
| Protrusion beyond Hold Down Tape       | I <sub>2</sub>  | I <sub>2</sub> | Not Specified  | —          |
| Sprocket Hole Pitch                    | P <sub>0</sub>  | P <sub>0</sub> | 12.7           | ±0.3       |
| Device Pitch (TRF250 and TRF600-150)   | —               | —              | 12.7           | —          |
| Device Pitch (TRF600-160 - TRF600-400) | —               | —              | 25.4           | —          |
| Pitch Tolerance                        | —               | —              | 20 Consecutive | ±1         |
| Tape Thickness                         | t               | t              | 0.9            | Max        |
| Tape Thickness with Splice*            | t <sub>1</sub>  | —              | 2.0            | Max        |
| Splice Sprocket Hole Alignment         | —               | —              | 0              | ±0.3       |
| Body Lateral Deviation                 | Δh              | Δh             | 0              | ±1.0       |
| Body Tape Plane Deviation              | Δp              | Δp             | 0              | ±1.3       |
| Lead Spacing Plane Deviation           | ΔP <sub>1</sub> | P <sub>1</sub> | 0              | ±0.7       |
| Lead Spacing*                          | F               | F              | 5.08           | ±0.6       |
| Reel Width                             | w <sub>2</sub>  | w              | 56             | Max        |
| Reel Diameter                          | a               | d              | 370            | Max        |
| Space between Flanges Less Device      | w <sub>1</sub>  | —              | 4.75           | ±3.25      |
| Arbor Hole Diameter                    | c               | f              | 26             | ±12.0      |
| Core Diameter                          | n               | h              | 80             | Max        |
| Box                                    | —               | —              | 56/372/372     | Max        |
| Consecutive Missing Pieces*            | —               | —              | 3 Max          | —          |
| Empty Places per Reel*                 | —               | —              | Not Specified  | —          |

\* Differs from EIA specification.

**Figure T23 EIA Referenced Taped Component Dimensions for PolySwitch Telecommunications Radial-Leaded Devices**



**Figure T24 Reel Dimensions for PolySwitch Telecommunications Radial-Leaded Devices**

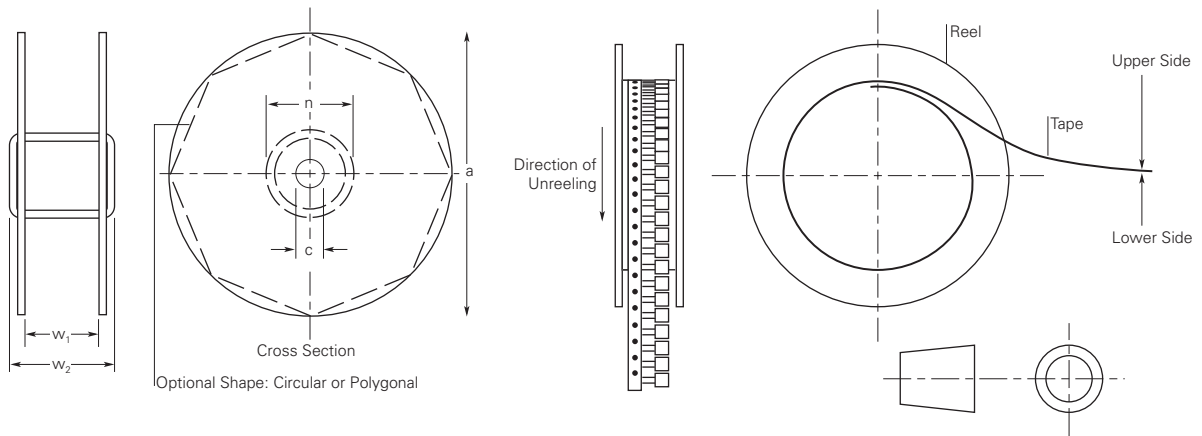

**Table T9 TS Tape and Reel Specifications for PolySwitch Telecommunications and Networking Devices**

TS devices are packaged per EIA 481 and EIA 481-2 standards. See Figures T25 and T26 for details.

**TS250/TSL250/TSV250**

| Dimension Description       | EIA Mark           | TS250          |                | TSV250         |                | TSL250         |                |
|-----------------------------|--------------------|----------------|----------------|----------------|----------------|----------------|----------------|
|                             |                    | Dimension (mm) | Tolerance (mm) | Dimension (mm) | Tolerance (mm) | Dimension (mm) | Tolerance (mm) |
| Carrier Tape Width          | W                  | 16             | ±0.30          | 16.0           | ±0.30          | 16             | ±0.30          |
| Sprocket Hole Pitch         | P <sub>0</sub>     | 4.0            | ±0.10          | 4.0            | ±0.10          | 4.0            | ±0.10          |
|                             | P <sub>1</sub>     | 12.0           | ±0.10          | 8.0            | ±0.10          | 8.0            | ±0.10          |
|                             | P <sub>2</sub>     | 2.0            | ±0.10          | 2.0            | ±0.10          | 2.0            | ±0.10          |
|                             | A <sub>0</sub>     | 6.9            | ±0.23          | 5.5            | ±0.10          | 5.5            | ±0.10          |
|                             | B <sub>0</sub>     | 9.6            | ±0.15          | 6.2            | ±0.10          | 7.9            | ±0.10          |
|                             | B <sub>1</sub> max | 12.1           | —              | 8.0            | —              | 9.2            | —              |
| Sprocket Hole Diameter      | D <sub>0</sub>     | 1.5            | -0/+0.1        | 1.55           | ±0.05          | 1.55           | ±0.05          |
|                             | F                  | 7.5            | ±0.10          | 7.5            | ±0.10          | 7.5            | ±0.10          |
|                             | E <sub>1</sub>     | 1.75           | ±0.10          | 1.75           | ±0.10          | 1.75           | ±0.10          |
|                             | E <sub>2</sub> min | 14.25          | —              | —              | —              | —              | —              |
| Tape Thickness              | T max              | 0.4            | —              | 0.45           | —              | 0.35           | —              |
| Tape Thickness With         | T <sub>1</sub> max | 0.1            | —              | 0.1            | —              | 0.1            | —              |
| Splice Cover Tape Thickness | K <sub>0</sub>     | 3.4            | ±0.15          | 7.0            | ±0.10          | 3.70           | ±0.10          |
|                             | Leader min         | 300            | —              | 390            | —              | 390            | —              |
|                             | Trailer min        | 300            | —              | 160            | —              | 160            | —              |

**Reel Dimensions**

|                                   |                    |      |         |      |         |      |         |
|-----------------------------------|--------------------|------|---------|------|---------|------|---------|
| Reel Diameter                     | A max              | 340  | —       | 340  | —       | 340  | —       |
| Core Diameter                     | N min              | 50   | —       | 50   | —       | 50   | —       |
| Space between Flanges-less Device | W <sub>1</sub>     | 16.4 | -0/+2.0 | 16.4 | -0/+2.0 | 16.4 | -0/+2.0 |
| Reel Width                        | W <sub>2</sub> max | 22.4 | —       | 22.4 | —       | 22.4 | —       |

**TS600**

| Dimension Description      | EIA Mark           | Dimension (mm) | Tolerance |
|----------------------------|--------------------|----------------|-----------|
| Carrier Tape Width         | W                  | 32             | ±0.3      |
| Sprocket Hole Pitch        | P <sub>0</sub>     | 4.0            | ±0.1      |
|                            | P <sub>1</sub>     | 16             | ±0.1      |
|                            | P <sub>2</sub>     | 2.0            | ±0.1      |
|                            | A <sub>0</sub>     | 10             | ±0.1      |
|                            | B <sub>0</sub>     | 19.2           | ±0.1      |
|                            | B <sub>1</sub> max | 21.6           | —         |
| Sprocket Hole Diameter     | D <sub>0</sub>     | 1.5            | -0/+1.0   |
|                            | F                  | 14.2           | ±0.1      |
|                            | E <sub>1</sub>     | 1.75           | ±0.1      |
|                            | E <sub>2</sub> min | 28.4           | ±0.1      |
| Tape Thickness             | T max              | 0.50           | ±0.5      |
| Tape Thickness with Splice | T <sub>1</sub> max | 0.1            | —         |
|                            | K <sub>0</sub>     | 13.2           | ±0.1      |
|                            | Leader min         | 390            | —         |
|                            | Trailer min        | 160            | —         |

**Reel Dimensions**

|                                   |                    |      |         |
|-----------------------------------|--------------------|------|---------|
| Reel Diameter                     | A max              | 360  | —       |
| Core Diameter                     | N min              | 50   | —       |
| Space between Flanges-less Device | W <sub>1</sub>     | 32.4 | -0/+2.0 |
| Reel Width                        | W <sub>2</sub> max | 40   | —       |

**Table T9 TS Tape and Reel Specifications for PolySwitch Telecommunications and Networking Devices** Cont'd

TS devices are packaged per EIA 481 and EIA 481-2 standards. See Figures T25 and T26 for details.

**TSM600**

| Dimension Description      | EIA Mark           | Dimension (mm) | Tolerance |
|----------------------------|--------------------|----------------|-----------|
| Carrier Tape Width         | W                  | 32             | ±0.3      |
| Sprocket Hole Pitch        | P <sub>0</sub>     | 4.0            | ±0.1      |
|                            | P <sub>1</sub>     | 24             | ±0.1      |
|                            | P <sub>2</sub>     | 2.0            | ±0.1      |
|                            | A <sub>0</sub>     | 11.2           | ±0.1      |
|                            | B <sub>0</sub>     | 17.8           | ±0.1      |
|                            | B <sub>1</sub> max | 23.45          |           |
| Sprocket Hole Diameter     | D                  | 1.5            | -0/+1.0   |
|                            | F                  | 14.2           | ±0.1      |
|                            | E <sub>1</sub>     | 1.74           | ±0.1      |
|                            | E <sub>2</sub> max | 28.4           | ±0.1      |
| Tape Thickness             | T max              | 0.5            | ±0.5      |
| Tape Thickness with Splice | T <sub>1</sub> max | 0.1            |           |
|                            | K <sub>0</sub>     | 11.9           | ±0.1      |
|                            | Leader min         | 390            |           |
|                            | Trailer min        | 160            |           |

**Reel Dimensions**

|                                   |                    |      |         |
|-----------------------------------|--------------------|------|---------|
| Reel Diameter                     | A max              | 360  |         |
| Core Diameter                     | N min              | 50   |         |
| Space between Flanges-less Device | W <sub>1</sub>     | 32.4 | -0/+2.0 |
| Reel Width                        | W <sub>2</sub> max | 40   |         |

**Figure T25 EIA Referenced Taped Component Dimensions for PolySwitch Telecommunications and Networking Devices**



**Figure T26 EIA Referenced Reel Dimensions for PolySwitch Telecommunications and Networking Devices**



## PolySwitch Telecommunications and Networking Resistance-Sorted and Resistance-Matched Devices

Most TCF, TRF and TS devices are available in resistance-sorted and/or resistance-matched versions.

### Resistance-sorted Devices

Resistance-sorted devices (part number suffix “Rx”, where x = 1, 2, A, B, C, F, etc.) are supplied with resistance values that are within specified segments of the device’s full range of resistance.

#### Feature

- Narrow resistance range.

#### Benefits

- Can help provide greater flexibility for design engineers.
- Lower resistance devices can help provide increased loop length on line card designs.
- Higher resistance devices may help provide greater protection by offering faster time-to-trip.

### Resistance-matched Devices

Resistance-matched devices are supplied such that all parts in one particular package (or reel) are within 0.5Ω of each other (1.0Ω for TRF250-080T devices). Individual matched packages are supplied from the full resistance range of the specified device.

#### Feature

- Tighter resistance balance between any two parts in a package.

#### Benefits

- Resistance-matched devices may help reduce the tip-ring resistance differential, reducing the possibility of line imbalance.

## Part Numbering System for PolySwitch Radial-Leaded Telecommunications and Networking Devices

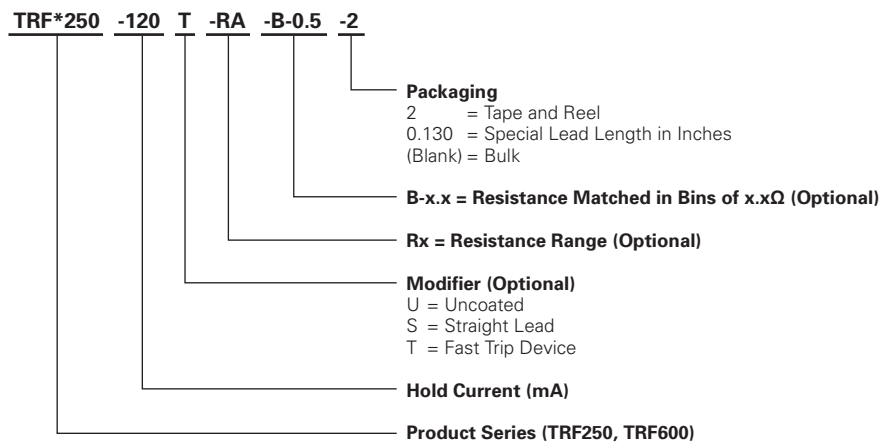

\* F = RoHS compliant, ELV compliant

## Part Numbering System for PolySwitch Surface-mount Telecommunications and Networking Devices

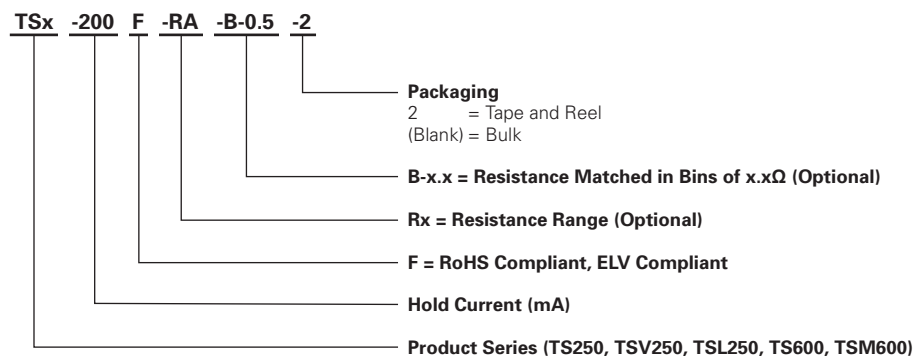

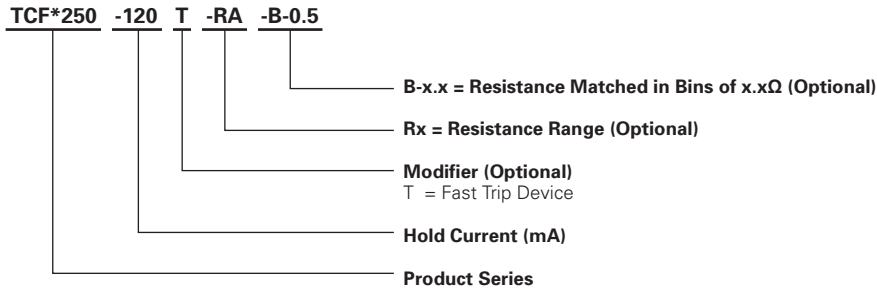

\* F = RoHS compliant, ELV compliant



**Warning :**

- Users should independently evaluate the suitability of and test each product selected for their own application.
- Operation beyond the maximum ratings or improper use may result in device damage and possible electrical arcing and flame.
- These devices are intended for protection against damage caused by occasional overcurrent or overtemperature fault conditions and should not be used when repeated fault conditions or prolonged trip events are anticipated.
- Contamination of the PPTC material with certain silicone-based oils or some aggressive solvents can adversely impact the performance of the devices.
- Device performance can be impacted negatively if devices are handled in a manner inconsistent with recommended electronic, thermal and mechanical procedures for electronic components.
- PPTC devices are not recommended for installation in applications where the device is constrained such that its PTC properties are inhibited, for example in rigid potting materials or in rigid housings, which lack adequate clearance to accommodate device expansion.
- Operation in circuits with a large inductance can generate a circuit voltage (Ldi/dt) above the rated voltage of the device.