

# HCPL-520x, HCPL-523x, HCPL-623x, HCPL-625x, 5962-88768 and 5962-88769<sup>1</sup>



## Hermetically Sealed Low IF, Wide VCC, Logic Gate Optocouplers

### Data Sheet

#### Description

These units are single, dual and quad channel, hermetically sealed optocouplers. The products are capable of operation and storage over the full military temperature range and can be purchased as either commercial product or with full MIL-PRF-38534 Class Level H or K testing or from the appropriate DLA Standard Microcircuit Drawing (SMD). All devices are manufactured and tested on a MIL-PRF-38534 certified line, and Class H and K devices are included in the DLA Qualified Manufacturers List QML-38534 for Hybrid Microcircuits.

Each channel contains an AlGaAs light emitting diode that is optically coupled to an integrated high gain photon detector. The detector has a threshold with hysteresis, which provides differential mode noise immunity and eliminates the potential for output signal chatter. The detector in the single-channel units has a tri-state output stage that allows for direct connection to data buses. The output is noninverting. The detector IC has an internal shield that provides a guaranteed common mode transient immunity of up to 10,000 V/ $\mu$ s. Improved power supply rejection eliminates the need for special power supply bypass precautions.

**CAUTION** It is advised that normal static precautions be taken in handling and assembly of this component to prevent damage and/or degradation which may be induced by ESD.

#### Features

- Dual marked with device part number and DLA Standard Microcircuit Drawing (SMD)
- Manufactured and tested on a MIL-PRF-38534 certified line
- QML-38534, Class H and K
- Four hermetically sealed package configurations
- Performance guaranteed over  $-55^{\circ}\text{C}$  to  $+125^{\circ}\text{C}$
- Wide  $V_{CC}$  range (4.5V to 20V)
- 350 ns maximum propagation delay
- CMR:  $> 10,000 \text{ V}/\mu\text{s}$  typical
- 1500 Vdc withstand test voltage
- Three-state output available
- High radiation immunity
- HCPL-2200/31 function compatibility
- Reliability data available
- Compatible with LSTTL, TTL, and CMOS logic

#### Applications

- Military and space
- High reliability systems
- Transportation and life critical systems
- High-speed line receiver
- Isolated bus driver (single channel)
- Pulse transformer replacement
- Ground loop elimination
- Harsh industrial environments
- Computer-peripheral interfaces

1. See [Selection Guide—Package Styles and Lead Configuration Options](#) for available extensions.

## Functional Diagram

Multiple-channel devices are available.



Package styles for these parts are 8-pin DIP through hole (case outline P), 16-pin DIP flat pack (case outline F), and leadless ceramic chip carrier (case outline 2). Devices can be purchased with a variety of lead bend and plating options. See [Selection Guide—Package Styles and Lead Configuration Options](#) for details. Standard Microcircuit Drawing (SMD) parts are available for each package and lead style.

Because the same electrical die (emitters and detectors) are used for each channel of each device listed in this data sheet, absolute maximum ratings, recommended operating conditions, electrical specifications, and performance characteristics shown in the figures are identical for all parts. Occasional exceptions exist due to package variations and limitations and are as noted. Additionally, the same package assembly processes are used in all devices. These similarities give justification for the use of data obtained from one part to represent other part's performance for die related reliability and certain limited radiation test results.

## Truth Tables

(Positive Logic)

| Multichannel Devices |        |
|----------------------|--------|
| Input                | Output |
| On (H)               | H      |
| Off (L)              | L      |

| Single Channel Devices |        |        |
|------------------------|--------|--------|
| Input                  | Enable | Output |
| On (H)                 | H      | Z      |
| Off (L)                | H      | Z      |
| On (H)                 | L      | H      |
| Off (L)                | L      | L      |

**NOTE** A 0.1- $\mu$ F bypass capacitor must be connected between  $V_{CC}$  and GND pins.

## Functional Diagrams



**NOTE** Multichannel DIP and flat pack devices have common  $V_{CC}$  and ground. Single-channel DIP has an enable pin 6. LCCC (leadless ceramic chip carrier) package has isolated channels with separate  $V_{CC}$  and ground connections. All diagrams are top view.

## Selection Guide–Package Styles and Lead Configuration Options

| Package                            | 8-Pin DIP               | 8-Pin DIP               | 16-Pin Flat Pack        | 20-Pad LCCC              |
|------------------------------------|-------------------------|-------------------------|-------------------------|--------------------------|
| Lead Style                         | Through Hole            | Through Hole            | Unformed Leads          | Surface Mount            |
| Channels                           | 1                       | 2                       | 4                       | 2                        |
| Common Channel Wiring              | None                    | V <sub>CC</sub> GND     | V <sub>CC</sub> GND     | None                     |
| <b>Part Numbers and Options</b>    |                         |                         |                         |                          |
| Commercial                         | HCPL-5200               | HCPL-5230               | HCPL-6250               | HCPL-6230                |
| MIL-PRF-38534 Class H              | HCPL-5201               | HCPL-5231               | HCPL-6251               | HCPL-6231                |
| MIL-PRF-38534 Class K              | HCPL-520K               | HCPL-523K               | HCPL-625K               | HCPL-623K                |
| Standard Lead Finish               | Gold Plate <sup>a</sup> | Gold Plate <sup>a</sup> | Gold Plate <sup>a</sup> | Solder Pads <sup>b</sup> |
| Solder Dipped <sup>b</sup>         | Option 200              | Option 200              |                         |                          |
| Butt Joint/Gold Plate <sup>a</sup> | Option 100              | Option 100              |                         |                          |
| Gull Wing/Soldered <sup>b</sup>    | Option 300              | Option 300              |                         |                          |
| <b>Class H SMD Part Number</b>     |                         |                         |                         |                          |
| Prescript for all below            | 5962-                   | 5962-                   | 5962-                   | 5962-                    |
| Gold Plate <sup>a</sup>            | 8876801PC               | 8876901PC               | 8876903FC               |                          |
| Solder Dipped <sup>b</sup>         | 8876801PA               | 8876901PA               |                         | 88769022A                |
| Butt Joint/Gold Plate <sup>a</sup> | 8876801YC               | 8876901YC               |                         |                          |
| Butt Joint/Soldered <sup>b</sup>   | 8876801YA               | 8876901YA               |                         |                          |
| Gull Wing/Soldered <sup>b</sup>    | 8876801XA               | 8876901XA               |                         |                          |
| <b>Class K SMD Part Number</b>     |                         |                         |                         |                          |
| Prescript for all below            | 5962-                   | 5962-                   | 5962-                   | 5962-                    |
| Gold Plate <sup>a</sup>            | 8876802KPC              | 8876904KPC              | 8876906KFC              |                          |
| Solder Dipped <sup>b</sup>         | 8876802KPA              | 8876904KPA              |                         | 8876905K2A               |
| Butt Joint/Gold Plate <sup>a</sup> | 8876802KYC              | 8876904KYC              |                         |                          |
| Butt Joint/Soldered <sup>b</sup>   | 8876802KYA              | 8876904KYA              |                         |                          |
| Gull Wing/Soldered <sup>b</sup>    | 8876802KXA              | 8876904KXA              |                         |                          |

- a. Gold Plate lead finish: Maximum gold thickness of leads is <100 micro inches. Typical is 60 to 90 micro inches.  
b. Solder lead finish: Sn63/Pb37.

## Outline Drawings

### 8-Pin DIP Through Hole, 1 and 2 Channel



NOTE: DIMENSIONS IN MILLIMETERS (INCHES).

### 16-Pin Flat Pack, 4 Channels



NOTE: DIMENSIONS IN MILLIMETERS (INCHES).

## 20-Terminal LCCC Surface Mount, 2 Channels



NOTE: DIMENSIONS IN MILLIMETERS (INCHES).  
SOLDER THICKNESS 0.127 (0.005) MAX.

## Leaded Device Marking



[1] QML PARTS ONLY

## Leadless Device Marking



[1] QML PARTS ONLY

## Hermetic Optocoupler Options

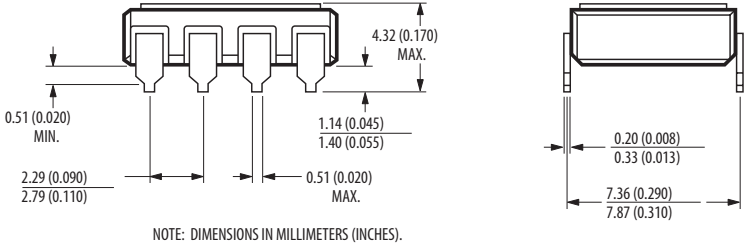
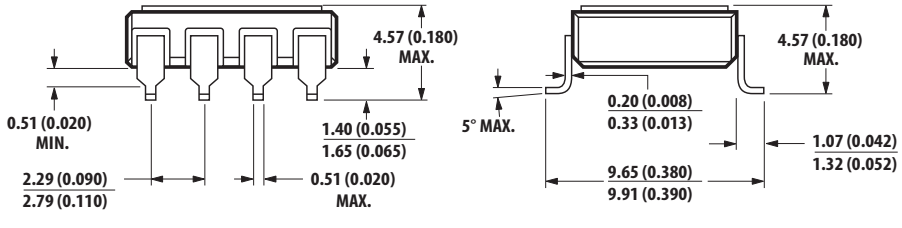
| Option | Description   |
|--------|---|
| 100    | <p>Surface-mountable hermetic optocoupler with leads trimmed for butt joint assembly. This option is available on Commercial, Class H and Class K product in 8-pin DIP.</p>  <p>NOTE: DIMENSIONS IN MILLIMETERS (INCHES).</p>  |
| 200    | <p>Lead finish is solder dipped rather than gold plated. This option is available on Commercial, Class H and Class K product in 8-pin DIP. DLA Drawing part numbers contain provisions for lead finish. All leadless chip carrier devices are delivered with solder-dipped terminals as a standard feature.</p>   |
| 300    | <p>Surface-mountable hermetic optocoupler with leads cut and bent for gull wing assembly. This option is available on Commercial, Class H and Class K product in 8-pin DIP. This option has solder-dipped leads.</p>  <p>NOTE: DIMENSIONS IN MILLIMETERS (INCHES).</p> |

## Absolute Maximum Ratings

| Parameter                               | Symbol             | Min  | Max             | Unit |
|---|--------------------|------|-----------------|------|
| Storage Temperature Range               | $T_S$              | -65  | +150            | °C   |
| Operating Ambient Temperature           | $T_A$              | -55  | +125            | °C   |
| Junction Temperature                    | $T_J$              | —    | +175            | °C   |
| Case Temperature                        | $T_C$              | —    | +170            | °C   |
| Lead Solder Temperature                 |                    | —    | 260 for 10 s    | °C   |
| Average Forward Current, each channel   | $I_{F\text{ AVG}}$ | —    | 8               | mA   |
| Peak Input Current, each channel        | $I_{F\text{ PK}}$  | —    | 20 <sup>a</sup> | mA   |
| Reverse Input Voltage, each channel     | $V_R$              | —    | 3               | V    |
| Average Output Current, each channel    | $I_O$              | —    | 15              | mA   |
| Supply Voltage                          | $V_{CC}$           | 0.0  | 20              | V    |
| Output Voltage, each channel            | $V_O$              | -0.3 | 20              | V    |
| Package Power Dissipation, each channel | $P_D$              | —    | 200             | mW   |
| <b>Single-Channel Product Only</b>      |                    |      |                 |      |
| Tri-State Enable Voltage                | $V_E$              | -0.3 | 20              | V    |

a. Peak Forward Input Current pulse width <50  $\mu$ s at 1-KHz maximum repetition rate.

## 8-Pin Ceramic DIP Single-Channel Schematic



Note: Enable pin 6. An external 0.01- $\mu$ F to 0.1- $\mu$ F bypass capacitor is recommended between VCC and ground for each package type.

## ESD Classification

| (MIL-STD-883, Method 3015)          |            |
|-------------------------------------|------------|
| HCPL-5200/01/0K and HCPL-6230/31/3K | ▲, Class 1 |
| HCPL-5230/31/3K and HCPL-6250/51/5K | ●, Class 3 |

## Recommended Operating Conditions

| Parameter                               | Symbol   | Min | Max | Unit |
|---|----------|-----|-----|------|
| Power Supply Voltage                    | $V_{CC}$ | 4.5 | 20  | V    |
| Input Current, High Level, Each Channel | $I_{FH}$ | 2   | 8   | mA   |
| Input Voltage, Low Level, Each Channel  | $V_{FL}$ | 0   | 0.8 | V    |
| Fan Out (TTL Load), Each Channel        | N        | —   | 4   |      |
| <b>Single Channel Product Only</b>      |          |     |     |      |
| High Level Enable Voltage               | $V_{EH}$ | 2.0 | 20  | V    |
| Low Level Enable Voltage                | $V_{EL}$ | 0   | 0.8 | V    |

## Electrical Characteristics

$T_A = -55^{\circ}\text{C}$  to  $+125^{\circ}\text{C}$ ,  $4.5\text{V} \leq V_{CC} \leq 20\text{V}$ ,  $2\text{ mA} \leq I_{F(\text{ON})} \leq 8\text{ mA}$ ,  $0\text{V} \leq V_{F(\text{OFF})} \leq 0.8\text{V}$ , unless otherwise specified.

| Parameter  | Symbol         | Group A Sub-groups <sup>a</sup> | Test Conditions  | Limits   |   |     | Unit             | Fig           | Notes   |      |    |
|--|----------------|---------------------------------|--|--|---|-----|------------------|---------------|---------|------|----|
|  |                |                                 |  | Min  | Typ <sup>b</sup>                                  | Max |                  |               |         |      |    |
| Logic Low Output Voltage                         | $V_{OL}$       | 1, 2, 3                         | $I_{OL} = 6.4\text{ mA}$<br>(4 TTL Loads)  | —  | —   | 0.5 | V                | 1, 3          | c       |      |    |
| Logic High Output Voltage                        | $V_{OH}$       | 1, 2, 3                         | $I_{OH} = -2.6\text{ mA}$<br>(** $V_{OH} = V_{CC} - 2.1\text{V}$ )                                     | 2.4  | **  | —   | V                | 2, 3          | c       |      |    |
|  |                | NA                              | $I_{OH} = -0.32\text{ mA}$   | —  | 3.1   | —   |                  |               |         |      |    |
| Output Leakage Current<br>( $V_{OUT} > V_{CC}$ ) | $I_{OHH}$      | 1, 2, 3                         | $V_O = 5.5\text{V}$  | $I_F = 8\text{ mA}$<br>$V_{CC} = 4.5\text{V}$    | —   | —   | 100              | $\mu\text{A}$ |         | c    |    |
|  |                |                                 | $V_O = 20\text{V}$   |  | —   | —   | 500              |               |         |      |    |
| Logic Low Supply Current                         | Single Channel | 1, 2, 3                         | $V_{CC} = 5.5\text{V}$   | $V_F = 0\text{V}$<br>$V_E = \text{Don't Care}$   | —   | 4.5 | 6                | mA            |         |      |    |
|  |                |                                 | $V_{CC} = 20\text{V}$  |  | —   | 5.3 | 7.5              |               |         |      |    |
|  | Dual Channel   |                                 | $V_{CC} = 5.5\text{V}$   |  | $V_{F1} = V_{F2} = 0\text{V}$                     | —   | 9.0              |               |         |      | 12 |
|  |                |                                 | $V_{CC} = 20\text{V}$  |  |   | —   | 10.6             |               |         |      | 15 |
|  | Quad Channel   |                                 | $V_{CC} = 5.5\text{V}$   |  | $V_{F1} = V_{F2} = V_{F3} = V_{F4} = 0\text{V}$   | —   | 14               |               |         |      | 24 |
|  |                |                                 | $V_{CC} = 20\text{V}$  |  |   | —   | 17               |               |         |      | 30 |
| Logic High Supply Current                        | Single Channel | 1, 2, 3                         | $V_{CC} = 5.5\text{V}$   | $I_F = 8\text{ mA}$<br>$V_E = \text{Don't Care}$ | —   | 2.9 | 4.5              | mA            |         |      |    |
|  |                |                                 | $V_{CC} = 20\text{V}$  |  | —   | 3.3 | 6                |               |         |      |    |
|  | Dual Channel   |                                 | $V_{CC} = 5.5\text{V}$   |  | $I_{F1} = I_{F2} = 8\text{ mA}$                   | —   | 5.8              |               |         |      | 9  |
|  |                |                                 | $V_{CC} = 20\text{V}$  |  |   | —   | 6.6              |               |         |      | 12 |
|  | Quad Channel   |                                 | $V_{CC} = 5.5\text{V}$   |  | $I_{F1} = I_{F2} = I_{F3} = I_{F4} = 8\text{ mA}$ | —   | 9                |               |         |      | 18 |
|  |                |                                 | $V_{CC} = 20\text{V}$  |  |   | —   | 11               |               |         |      | 24 |
| Logic Low Short Circuit Output Current           | $I_{OSL}$      | 1, 2, 3                         | $V_O = V_{CC} = 5.5\text{V}$   | $V_F = 0\text{V}$                                | 20  |     | mA               |               | c, d    |      |    |
|  |                |                                 | $V_O = V_{CC} = 20\text{V}$  |  | 35  |     |                  |               |         |      |    |
| Logic High Short Circuit Output Current          | $I_{OSH}$      | 1, 2, 3                         | $V_{CC} = 5.5\text{V}$   | $I_F = 8\text{ mA}$<br>$V_O = \text{GND}$        | —   | —   | -10              | mA            |         | c, d |    |
|  |                |                                 | $V_{CC} = 20\text{V}$  |  | —   | —   | -25              |               |         |      |    |
| Input Forward Voltage                            | $V_F$          | 1, 2, 3                         | $I_F = 8\text{ mA}$  | 1.0  | 1.3   | 1.8 | V                | 4             | c       |      |    |
| Input Reverse Breakdown Voltage                  | $BV_R$         | 1, 2, 3                         | $I_R = 10\text{ mA}$   | 3  | —   |     | V                |               | c       |      |    |
| Input-Output Insulation Leakage Current          | $I_{I-O}$      | 1                               | $V_{I-O} = 1500\text{ Vdc}$ , $t = 5\text{ s}$ ,<br>$\text{RH} \leq 65\%$ , $T_A = 25^{\circ}\text{C}$ | —  | —   | 1.0 | $\mu\text{A}$    |               | e, f    |      |    |
| Logic High Common Mode Transient Immunity        | $ CM_H $       | 9, 10, 11                       | $I_F = 2\text{ mA}$ , $V_{CM} = 50\text{ V}_{P-P}$   | 1000   | 10,000  |     | V/ $\mu\text{s}$ | 9             | c, g, h |      |    |



| Parameter                                | Symbol           | Group A Sub-groups <sup>a</sup> | Test Conditions   | Limits |                  |     | Unit | Fig  | Notes   |
|--|------------------|---------------------------------|---|--------|------------------|-----|------|------|---------|
|  |                  |                                 |   | Min    | Typ <sup>b</sup> | Max |      |      |         |
| Logic Low Common Mode Transient Immunity | CM <sub>L</sub>  | 9, 10, 11                       | I <sub>F</sub> = 0 mA, V <sub>CM</sub> = 50V <sub>P-P</sub> | 1000   | 10,000           |     | V/μs | 9    | c, g, h |
| Propagation Delay Time to Logic Low      | t <sub>PHL</sub> | 9, 10, 11                       |   | —      | 173              | 350 | ns   | 5, 6 | c, i    |
| Propagation Delay Time to Logic High     | t <sub>PLH</sub> | 9, 10, 11                       |   | —      | 118              | 350 | ns   | 5, 6 | c, i    |

- Commercial parts receive 100% testing at 25°C (Subgroups 1 and 9). SMD, Class H and Class K parts receive 100% testing at 25, 125, and -55°C (Subgroups 1 and 9, 2 and 10, 3 and 11, respectively).
- All typical values are at V<sub>CC</sub> = 5V, T<sub>A</sub> = 25°C, I<sub>F(ON)</sub> = 5 mA unless otherwise specified.
- Each channel of a multichannel device.
- Duration of output short circuit time not to exceed 10 ms.
- All devices are considered two-terminal devices: measured between all input leads or terminals shorted together and all output leads or terminals shorted together.
- This is a momentary withstand test, not an operating condition.
- CM<sub>L</sub> is the maximum rate of rise of the common mode voltage that can be sustained with the output voltage in the logic low state (V<sub>O</sub> < 0.8V). CM<sub>H</sub> is the maximum rate of fall of the common mode voltage that can be sustained with the output voltage in the logic high state (V<sub>O</sub> > 2.0V).
- Parameters are tested as part of device initial characterization and after design and process changes. Parameters guaranteed to limits specified for all lots not specifically tested.
- t<sub>PHL</sub> propagation delay is measured from the 50% point on the leading edge of the input pulse to the 1.3V point on the leading edge of the output pulse. The t<sub>PLH</sub> propagation delay is measured from the 50% point on the trailing edge of the input pulse to the 1.3V point on the trailing edge of the output pulse.

## Electrical Characteristics - Single Channel Product Only

T<sub>A</sub> = -55°C to +125°C, 4.5V ≤ V<sub>CC</sub> ≤ 20V, 2 mA ≤ I<sub>F(ON)</sub> ≤ 8 mA, 0V ≤ V<sub>F(OFF)</sub> ≤ 0.8V, unless otherwise specified.

| Parameter                           | Symbol           | Group A, Sub-groups <sup>a</sup> | Test Conditions        |  | Limits |                  |       | Unit |
|-------------------------------------|------------------|----------------------------------|------------------------|--|--------|------------------|-------|------|
|                                     |                  |                                  |                        |  | Min    | Typ <sup>b</sup> | Max   |      |
| High Impedance State Output Current | I <sub>OZL</sub> | 1, 2, 3                          | V <sub>O</sub> = 0.4V  | V <sub>EN</sub> = 2V,<br>V <sub>F</sub> = 0V   | —      | —                | -20   | μA   |
|                                     |                  |                                  |                        |  | —      | —                | 20    |      |
|                                     | I <sub>OZH</sub> | 1, 2, 3                          | V <sub>O</sub> = 2.4V  | V <sub>EN</sub> = 2V,<br>I <sub>F</sub> = 8 mA | —      | —                | 100   | μA   |
|                                     |                  |                                  |                        |  | —      | —                | 500   |      |
| Logic High Enable Voltage           | V <sub>EH</sub>  | 1, 2, 3                          |                        |  | 2.0    |                  | V     |      |
| Logic Low Enable Voltage            | V <sub>EL</sub>  | 1, 2, 3                          |                        |  | —      | —                | 0.8   | V    |
| Logic High Enable Current           | I <sub>EH</sub>  | 1, 2, 3                          | V <sub>EN</sub> = 2.7V |  | —      | —                | 20    | μA   |
|                                     |                  |                                  | V <sub>EN</sub> = 5.5V |  | —      | —                | 100   |      |
|                                     |                  |                                  | V <sub>EN</sub> = 20V  |  | —      | 0.004            | 250   |      |
| Logic Low Enable Current            | I <sub>EL</sub>  | 1, 2, 3                          | V <sub>EN</sub> = 0.4V |  | —      | —                | -0.32 | mA   |

- Commercial parts receive 100% testing at 25°C (Subgroups 1 and 9). SMD, Class H and Class K parts receive 100% testing at 25, 125, and -55°C (Subgroups 1 and 9, 2 and 10, 3 and 11, respectively).
- All typical values are at V<sub>CC</sub> = 5V, T<sub>A</sub> = 25°C, I<sub>F(ON)</sub> = 5 mA unless otherwise specified.

## Typical Characteristics

All typical values are at  $T_A = 25^\circ\text{C}$ ,  $V_{CC} = 5\text{V}$ ,  $I_{F(\text{ON})} = 5\text{ mA}$ .

| Parameter                              | Symbol                          | Test Conditions   | Typ       | Unit                 | Fig  | Notes |
|--|---------------------------------|---|-----------|----------------------|------|-------|
| Input Current Hysteresis               | $I_{\text{HYS}}$                | $V_{CC} = 5\text{V}$  | 0.07      | mA                   | 3    | a     |
| Input Diode Temperature Coefficient    | $\frac{\Delta V_F}{\Delta T_A}$ | $I_F = 8\text{ mA}$   | -1.25     | mV/ $^\circ\text{C}$ |      | a     |
| Resistance (Input-Output)              | $R_{\text{I-O}}$                | $V_{\text{I-O}} = 500\text{ Vdc}$                                     | $10^{13}$ | $\Omega$             |      | a, b  |
| Capacitance (Input-Output)             | $C_{\text{I-O}}$                | $f = 1\text{ MHz}$  | 2.0       | pF                   |      | a, b  |
| Input Capacitance                      | $C_{\text{IN}}$                 | $V_F = 0\text{ V}$ , $f = 1\text{ MHz}$                               | 20        | pF                   |      | a, c  |
| Output Rise Time (10% to 90%)          | $t_r$                           |   | 45        | ns                   | 5, 7 | a     |
| Output Fall Time (90% to 10%)          | $t_f$                           |   | 10        | ns                   | 5, 7 | a     |
| <b>Single-Channel Product Only</b>     |                                 |   |           |                      |      |       |
| Output Enable Time to Logic High       | $t_{\text{PZH}}$                |   | 30        | ns                   | 8    |       |
| Output Enable Time to Logic Low        | $t_{\text{PZL}}$                |   | 30        | ns                   | 8    |       |
| Output Disable Time from Logic High    | $t_{\text{PHZ}}$                |   | 45        | ns                   | 8    |       |
| Output Disable Time from Logic Low     | $t_{\text{PLZ}}$                |   | 55        | ns                   | 8    |       |
| <b>Multi-Channel Product Only</b>      |                                 |   |           |                      |      |       |
| Input-Input Insulation Leakage Current | $I_{\text{I-I}}$                | $RH \leq 65\%$ ,<br>$V_{\text{I-I}} = 500\text{V}$ , $t = 5\text{ s}$ | 0.5       | nA                   |      | d     |
| Resistance (Input-Input)               | $R_{\text{I-I}}$                | $V_{\text{I-I}} = 500\text{V}$  | $10^{13}$ | $\Omega$             |      | d     |
| Capacitance (Input-Input)              | $C_{\text{I-I}}$                | $f = 1\text{ MHz}$  | 1.5       | pF                   |      | d     |

- a. Each channel of a multichannel device.
- b. Measured between each input pair shorted together and all output connections for that channel shorted together.
- c. Zero-bias capacitance measured between the LED anode and cathode.
- d. Measured between adjacent input pairs shorted together for each multichannel device.

Figure 1 Typical Logic Low Output Voltage vs. Temperature



Figure 2 Typical Logic High Output Current vs. Temperature

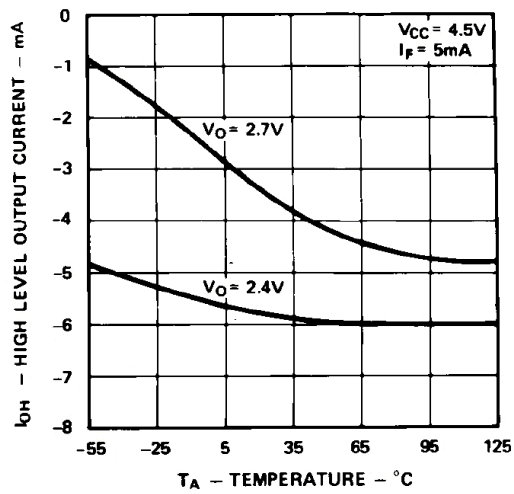

Figure 3 Output Voltage vs. Forward Input Current



Figure 4 Typical Diode Input Forward Characteristic



Figure 5 Test Circuit for  $t_{PLH}$ ,  $t_{PHL}$ ,  $t_r$  and  $t_f$

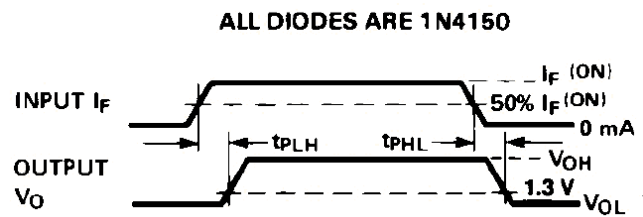

**Figure 6 Typical Propagation Delay vs. Temperature**



**Figure 7 Typical Rise, Fall Time vs. Temperature**



**Figure 8 Test Circuit for  $t_{pHZ}$ ,  $t_{pZH}$ ,  $t_{pLZ}$ , and  $t_{pZL}$**

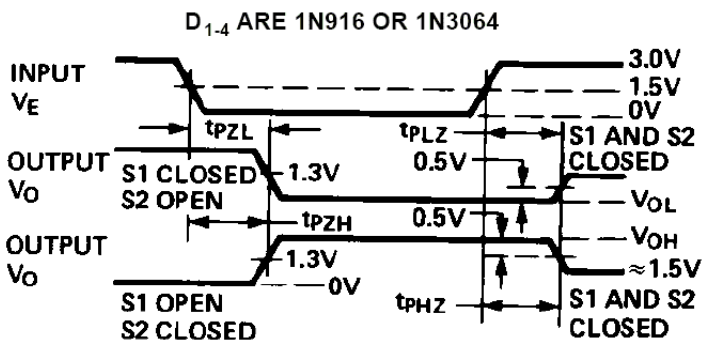

**Figure 9 Test Circuit for Common Mode Transient Immunity and Typical Waveforms**

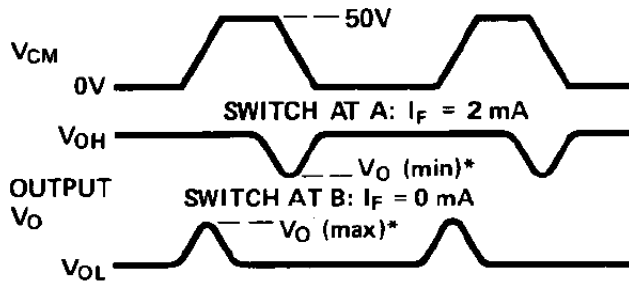
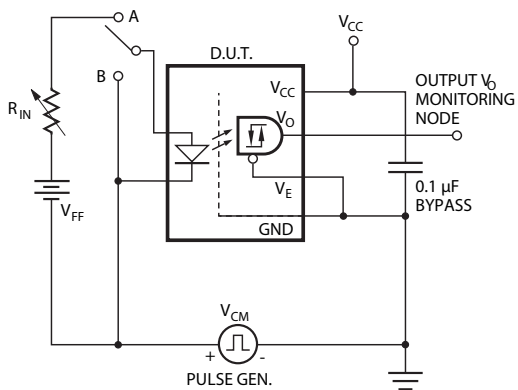

\*SEE NOTE 6.

**Figure 10 LSTTL to CMOS Interface Circuit**



**Figure 11 Recommended LED Drive Circuit**



**Figure 12 Series LED Drive with Open Collector Gate (4.02 kΩ Resistor Shunts  $I_{OH}$  from the LED)**



**Figure 13 Recommended LSTTL to LSTTL Circuit**



**Figure 14 Single-Channel Operating Circuit for Burn-in and Steady State Life Tests**



CONDITIONS:  $I_F = 8 \text{ mA}$   
 $I_O = -14 \text{ mA}$

$T_A = +125 \text{ }^\circ\text{C}$

\*ALL CHANNELS TESTED SIMULTANEOUSLY.

---

For product information and a complete list of distributors, please go to our web site: [www.broadcom.com](http://www.broadcom.com).

Broadcom, the pulse logo, Connecting everything, Avago Technologies, Avago, and the A logo are among the trademarks of Broadcom in the United States, certain other countries and/or the EU.

Copyright © 2005-2017 Broadcom. All Rights Reserved.

The term "Broadcom" refers to Broadcom Limited and/or its subsidiaries. For more information, please visit [www.broadcom.com](http://www.broadcom.com).

Broadcom reserves the right to make changes without further notice to any products or data herein to improve reliability, function, or design.

Information furnished by Broadcom is believed to be accurate and reliable. However, Broadcom does not assume any liability arising out of the application or use of this information, nor the application or use of any product or circuit described herein, neither does it convey any license under its patent rights nor the rights of others.

AV02-3840EN – January 6, 2017

