



## Micro-D Printed Circuit Board Connectors Condensed Board Straight CBS .075 Inch Spacing



**Save Space On Your Circuit Board**—These Micro-D connectors feature .075 inch row spacing. The board footprint is reduced to match the size of the connector body.

**Designed for Flex Circuits**—CBS COTS connectors are available with jackscrews for flex circuit compatibility.

**Solder-Dipped**—Terminals are coated with SN63/Pb37 tin-lead solder for best solderability. Optional gold-plated terminals are available for RoHS compliance.

**High Performance**—These connectors meet the demanding requirements of MIL-DTL-83513. Suitable for Level 1 NASA reliability.

### HOW TO ORDER CBS CONDENSED BOARD STRAIGHT CONNECTORS

Series	Shell Material and Plating Finish	Insulator Material	Number of Contacts	Contact Type	Termination Style	Hardware Option	PC Tail Length	Gold-Plated Terminal Mod Code	
<b>MWDM</b> Micro-D Metal Shell	Aluminum Shell	<b>L</b> LCP (Liquid Crystal Polymer)	<b>9</b>	<b>P</b> Pin	<b>CBS</b>  Condensed Board Straight	<b>NN</b> –No Jackpost, No Threaded Insert	<b>.080</b>	These connectors are solder-dipped in 63/37 tin- lead solder.  <b>To delete the solder dip and change to gold-plated terminals, add code 513</b>	
	<b>1</b> – Cadmium		<b>15</b>				<b>S</b> Socket		<b>PN</b> –Extended Jackpost for .062" (1.6) PCB, No Threaded Insert
	<b>2</b> – Nickel		<b>21</b>	<b>RN</b> –Extended Jackpost for .196" (5.0) PCB, No Threaded Insert		<b>.140</b>			
	<b>4</b> – Black Anodize		<b>25</b>			<b>NU</b> –Threaded Insert Only, No Jackposts	<b>.172</b>		
	<b>5</b> – Gold		<b>31</b>	<b>PU</b> –Short Jackpost and Threaded Insert			<b>.190</b>		
	<b>6</b> – Chem Film		<b>37</b>			Rear Panel Jackposts With Threaded Inserts	<b>.250</b>		
	Stainless Steel Shell	<b>51</b>	<b>R6U</b> – 0.125" (3.2) Panel <b>R5U</b> – 0.094" (2.4) Panel <b>R4U</b> – 0.062" (1.6) Panel <b>R3U</b> – 0.047" (1.2) Panel <b>R2U</b> – 0.031" (0.8) Panel <b>Jackscrew Options</b> <b>M</b> – Hex Head Jackscrews <b>S</b> – Slot Head Jackscrews	Length in Inches					
	<b>3</b> – Passivated	<b>69</b>		<b>± .015</b> (0.38)					
		<b>100</b>							
	<b>Sample Part Number</b>								
	<b>MWDM</b>	<b>1</b>	<b>L –</b>	<b>31</b>	<b>P</b>	<b>CBS</b>	<b>NN</b>	<b>– .110</b>	

**HARDWARE OPTIONS**  
See Pages C-16 and C-17

# Micro-D Printed Circuit Board Connectors Condensed Board Straight CBS .075 Inch Spacing



Micro-D  
PCB

## PERFORMANCE SPECIFICATIONS

Current Rating	3 AMP
DWV	600 VAC Sea level
Insulation Resistance	5000 Megohms Minimum
Contact Resistance	8 Milliohms Maximum
Low Level Contact Resist.	32 Milliohms Maximum
Magnetic Permeability	2 $\mu$ Maximum
Operating Temperature	-55° C. to +150° C.
Shock, Vibration	50 g., 20g.
Mating Force	(10 Ounces) X (# of Contacts)

## MATERIALS AND FINISHES

Connector Shell	Aluminum Alloy 6061 or Stainless Steel, 300 Series, passivated. See Ordering Info for Plating Options
Insulator, Tray	Liquid Crystal Polymer (LCP)
Interfacial Seal	Fluorosilicone Rubber, Blue
Pin Contact	Copper Alloy, Gold over Nickel Plating
Socket Contact	Copper Alloy, Gold Over Nickel Plating
PCB Terminals	Gold Plated Copper Alloy, Solder Dipped
Hardware	300 Series Stainless Steel
Encapsulant	Epoxy Resin Hysol EE4215

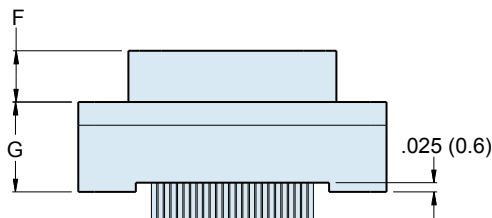

## MICRO-D CBS BOARD MOUNT CONNECTOR DIMENSIONS

Layout	A Max.		B		C Max.		D Max.		E Max.		F		G Max.	
	In.	mm.	In. ±.005	mm. ±0.13	In.	mm.	In.	mm.	In.	mm.	In. ±.003	mm. ±.008	In.	mm.
9P	.785	19.94	.565	14.35	.333	8.46	.184	4.67	.310	7.87	.183	4.65	.355	9.02
9S	.785	19.94	.565	14.35	.400	10.16	.250	6.35	.310	7.87	.195	4.95	.355	9.02
15P	.935	23.75	.715	18.16	.483	12.27	.184	4.67	.310	7.87	.183	4.65	.355	9.02
15S	.935	23.75	.715	18.16	.551	14.00	.250	6.35	.310	7.87	.195	4.95	.355	9.02
21P	1.085	27.56	.865	21.97	.633	16.08	.184	4.67	.310	7.87	.183	4.65	.355	9.02
21S	1.085	27.56	.865	21.97	.701	17.81	.250	6.35	.310	7.87	.195	4.95	.355	9.02
25P	1.185	30.01	.965	24.51	.733	18.62	.184	4.67	.310	7.87	.183	4.65	.355	9.02
25S	1.185	30.01	.965	24.51	.801	20.35	.250	6.35	.310	7.87	.195	4.95	.355	9.02
31P	1.335	33.91	1.115	28.32	.883	22.43	.184	4.67	.310	7.87	.183	4.65	.355	9.02
31S	1.335	33.91	1.115	28.32	.951	24.16	.250	6.35	.310	7.87	.195	4.95	.355	9.02
37P	1.485	37.72	1.265	32.13	1.033	26.24	.184	4.67	.310	7.87	.183	4.65	.355	9.02
37S	1.485	37.72	1.265	32.13	1.101	27.96	.250	6.35	.310	7.87	.195	4.95	.355	9.02
51P	1.435	36.45	1.215	30.86	.983	24.97	.228	5.79	.400	10.16	.183	4.65	.355	9.02
51S	1.435	36.45	1.215	30.86	1.051	26.70	.296	7.52	.400	10.16	.195	4.95	.355	9.02
69P	1.735	44.07	1.515	38.48	1.284	32.61	.224	5.69	.400	10.16	.183	4.65	.355	9.02
69S	1.735	44.07	1.515	38.48	1.350	34.29	.293	7.44	.400	10.16	.195	4.95	.355	9.02
100P	2.170	55.12	1.800	45.72	1.383	35.13	.270	6.86	.510	12.95	.183	4.65	.430	10.92
100S	2.170	55.12	1.800	45.72	1.451	36.86	.333	8.46	.510	12.95	.195	4.95	.430	10.92



# Micro-D Printed Circuit Board Connectors Condensed Board Straight CBS .075 Inch Spacing

## MICRO-D CBS BOARD MOUNT CONNECTOR HARDWARE OPTIONS

C



A DIAMETER  
9-69 CONTACTS  
.096/.088 (2.44/2.24)  
100 CONTACTS  
.150/.145 (3.81/3.68)

**NN Style**  
Thru-Hole, No Hardware



9-69 CONTACTS  
NO. 2-56 UNC-2B  
100 CONTACTS  
NO. 4-40 UNC-2B

**NU Style**  
Threaded Insert



.160 (4.1) MIN. (9-69 PINS)  
.225 (5.7) MIN. (100 PIN)

**PU Style**  
Jackpost with Threaded Insert



Kit Part Number **500-063-1**  
Kit Consists of Two Jackposts

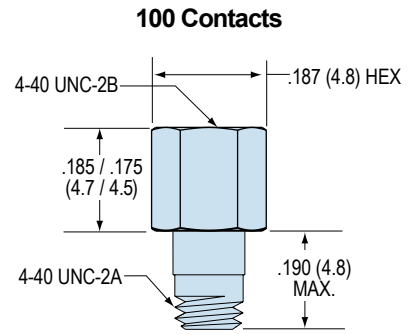

Kit Part Number **500-063-2**  
Kit Consists of Two Jackposts

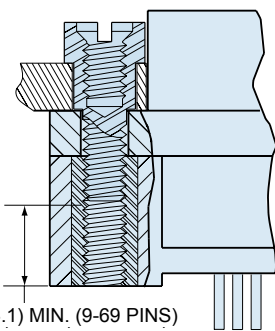

.160 (4.1) MIN. (9-69 PINS)  
.225 (5.7) MIN. (100 PIN)

**RU Style**  
Jackpost For Rear Panel  
Mounting, with Threaded Insert

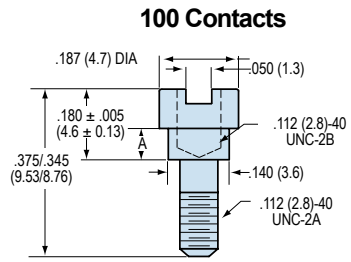
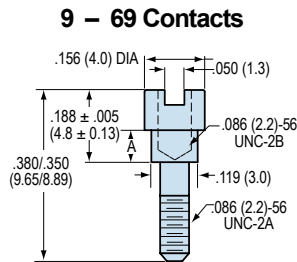

Hardware Option	Panel Thickness	Part Number	A ± .003 (0.08)	Hardware Option	Panel Thickness	Part Number	A ± .003 (0.08)
R2U	1/32 (0.8)	177-505-A-2-2	.024 (0.6)	R2U	1/32 (0.8)	177-505-D-4-2	.024 (0.6)
R3U	3/64 (1.2)	177-505-A-2-3	.041 (1.0)	R3U	3/64 (1.2)	177-505-D-4-3	.041 (1.0)
R4U	1/16 (1.6)	177-505-A-2-4	.055 (1.4)	R4U	1/16 (1.6)	177-505-D-4-4	.055 (1.4)
R5U	3/32 (2.4)	177-505-A-2-5	.086 (2.2)	R5U	3/32 (2.4)	177-505-D-4-5	.086 (2.2)
R6U	1/8 (3.2)	177-505-A-2-6	.118 (3.0)	R6U	1/8 (3.2)	177-505-D-4-6	.118 (3.0)

**Micro-D Printed Circuit Board Connectors  
Condensed Board  
Straight CBS .075 Inch Spacing**



Micro-D  
PCB

**MICRO-D CBS BOARD MOUNT CONNECTOR HARDWARE OPTIONS**



**PN Style** for .062" PCB  
**RN Style** for .196" PCB  
Jackpost Kit

**9 – 69 Contacts**

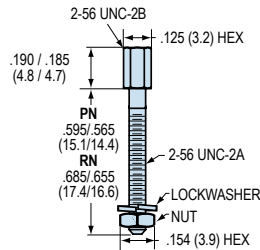

PN Kit Part Number **500-069-2-6**  
RN Kit Part Number **500-069-2-7**  
Kit Consists of 2 Jackposts, 2 Nuts, 2 Washers

**100 Contacts**



PN Kit Part Number **500-069-4-7**  
RN Kit Part Number **500-069-4-8**  
Kit Consists of 2 Jackposts, 2 Nuts, 2 Washers



**M Style**  
Hex Head Jackscrew with  
E-Ring

**9 – 69 Contacts**



Kit Part Number **500-080-2**  
Kit Consists of 2 Jackscrews and 2 E-Rings

**100 Contacts**



Kit Part Number **500-080-4**  
Kit Consists of 2 Jackscrews and 2 E-Rings



**S Style**  
Slot Head Jackscrew with  
E-Ring

**9 – 69 Contacts**



Kit Part Number **500-081-2**  
Kit Consists of 2 Jackscrews and 2 E-Rings

**100 Contacts**

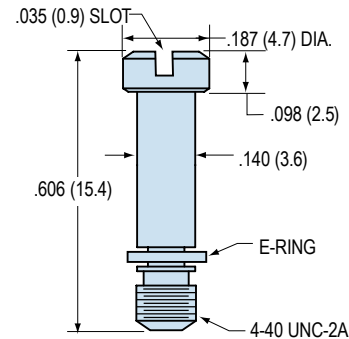

Kit Part Number **500-081-4**  
Kit Consists of 2 Jackscrews and 2 E-Rings

Patterns shown are for connector mounting side of PC board.

## MICRO-D CBS BOARD MOUNT CONNECTOR PCB LAYOUTS – PIN CONNECTORS



9 PIN MWDM-9PCBS



15 PIN MWDM-15PCBS



21 PIN MWDM-21PCBS



25 PIN MWDM-25PCBS



31 PIN MWDM-31PCBS



37 PIN MWDM-37PCBS



51 PIN MWDM-51PCBS



69 PIN MWDM-69PCBS



100 PIN MWDM-100PCBS

# Micro-D Printed Circuit Board Connectors Condensed Board Straight CBS .075 Inch Spacing



Micro-D  
PCB

Patterns shown are for connector mounting side of PC board.

## MICRO-D CBS BOARD MOUNT CONNECTOR PCB LAYOUTS – SOCKET CONNECTORS



9 Socket MWDM-9SCBS



15 Socket MWDM-15SCBS



21 Socket MWDM-21SCBS



25 Socket MWDM-25SCBS



31 Socket MWDM-31SCBS



37 Socket MWDM-37SCBS

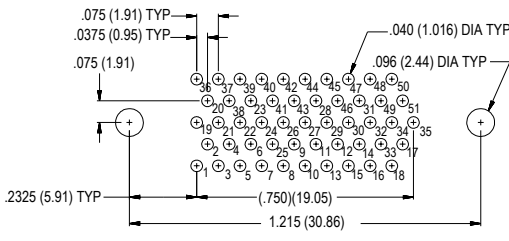

51 Socket MWDM-51SCBS

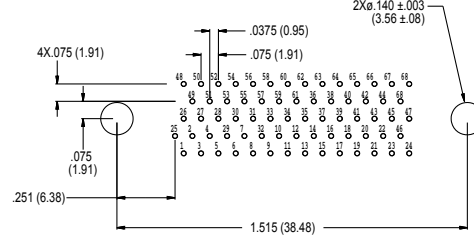

69 Socket MWDM-69SCBS



100 Socket MWDM-100SCBS